

# Highway Safety and Truck Crash Comparative Analysis Technical Report

Comprehensive  
Truck Size and  
Weight Limits  
Study

June 2015



U.S. Department  
of Transportation

**Federal Highway  
Administration**

## EXECUTIVE SUMMARY

### **Background**

This report documents analyses conducted as part of the U.S. Department of Transportation (USDOT) *2014 Comprehensive Truck Size and Weight Limits Study* (2014 CTSW Study). As required by Section 32801 of MAP-21 [Moving Ahead for Progress in the 21st Century Act (P.L. 112-141)], Volumes I and II of the 2014 CTSW Study have been designed to meet the following legislative requirements:

- Subsection 32801 (a)(1): Analyze accident frequency and evaluate factors related to accident risk of vehicles to conduct a crash-based analyses, using data from states and limited data from fleets;
- Subsection 32801 (a)(2): Evaluate the impacts to the infrastructure in each State including the cost and benefits of the impacts in dollars; the percentage of trucks operating in excess of the Federal size and weight limits; and the ability of each state to recover impact costs;
- Subsection 32801 (a)(3): Evaluate the frequency of violations in excess of the Federal size and weight law and regulations, the cost of the enforcement of the law and regulations, and the effectiveness of the enforcement methods; Delivery of effective enforcement programs;
- Subsection 32801 (a)(4): Assess the impacts that vehicles have on bridges, including the impacts resulting from the number of bridge loadings; and
- Subsections 32801 (a)(5) and (6): Compare and contrast the potential safety and infrastructure impacts of the current Federal law and regulations regarding truck size and weight limits in relation to six-axle and other alternative configurations of tractor-trailers; and where available, safety records of foreign nations with truck size and weight limits and tractor-trailer configurations that differ from the Federal law and regulations. As part of this component of the study, estimate:
  - (A) the extent to which freight would likely be diverted from other surface transportation modes to principal arterial routes and National Highway System intermodal connectors if alternative truck configuration is allowed to operate and the effect that any such diversion would have on other modes of transportation;
  - (B) the effect that any such diversion would have on public safety, infrastructure, cost responsibilities, fuel efficiency, freight transportation costs, and the environment;
  - (C) the effect on the transportation network of the United States that allowing alternative truck configuration to operate would have; and
  - (D) the extent to which allowing alternative truck configuration to operate would result in an increase or decrease in the total number of trucks operating on principal arterial routes and National Highway System intermodal connectors.

To conduct the study, the USDOT, in conjunction with a group of independent stakeholders, identified six different vehicle configurations involving six-axle and other alternative configurations of tractor-trailer as specified in Subsection 32801 (a)(5), to assess the likely results of allowing widespread alternative truck configurations to operate on different highway networks. The six vehicle configurations were then used to develop the analytical scenarios for each of the five comparative analyses mandated by MAP-21. The use of these scenarios for each of the analyses in turn enabled the consistent comparison of analytical results for each of the six vehicle configurations identified for the overall study.

The results of this *2014 Comprehensive Truck Size and Weight Limits Study* (2014 CTSW Study) study are presented in a series of technical reports. These include:

*Volume I: Comprehensive Truck Size and Weight Limits Study – Technical Summary Report.*

This document gives an overview of the legislation and the study project itself, provides background on the scenarios selected, explains the scope and general methodology used to obtain the results, and gives a summary of the findings.

*Volume II: Comprehensive Truck Size and Weight Limits Study.* This volume comprises a set of the five comparative assessment documents that meet the technical requirements of the legislation as noted:

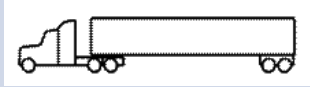
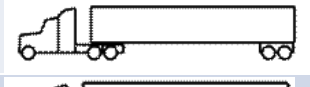
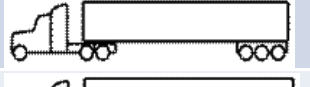
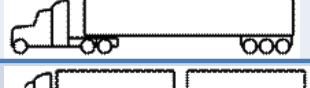


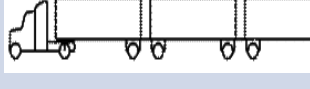

- *Modal Shift Comparative Analysis* (Subsections 32801 (a)(5) and (6)).
- *Pavement Comparative Analysis* (Section 32801 (a)(2)).
- *Highway Safety and Truck Crash Comparative Analysis* (Subsection 32801 (a)(1)).
- *Compliance Comparative Analysis* (Subsection 32801 (a)(3)).
- *Bridge Structure Comparative Analysis* (Subsection 32801 (a)(4)).

The USDOT study team conducted the safety analysis described in this *Volume II: Highway Safety and Truck Crash Comparative Analysis* report to explore differences in safety risk and truck crash frequency between truck configurations currently operating at and below current Federal size and weight limits on the Nation's roadways (control vehicles) as compared with a set of six alternative vehicle configurations that would hypothetically operate above the established Federal limits. This report also compares crash frequency and severity for both the control vehicles and the six alternative configuration scenarios defined for the 2014 CTSW Study (see Table ES-1 for the truck configuration and weight scenarios analyzed).

The first three scenarios assess tractor semitrailers that are heavier than generally allowed under currently Federal law. Scenario 1 assesses a five-axle (3-S2) semitrailer operating at a GVW of 88,000 pound, while Scenarios 2 and 3 assess six-axle (3-S3) semitrailers operating at GVWs of 91,000 and 97,000 pounds, respectively. The control vehicle for these scenario vehicles is the five-axle semitrailer with a maximum GVW of 80,000 pounds. This is the most common vehicle configuration used in long-haul over-the-road operations and carries the same kinds of commodities expected to be carried in the scenario vehicles.

Scenarios 4, 5, and 6 examine vehicles that would serve primarily less-than-truckload (LTL) traffic that currently is carried predominantly in five-axle (3-S2) semitrailers and five-axle (2-S1-

**Table ES-1: Truck Configuration and Weight Scenarios Analyzed in the 2014 CTSW Study**

| Scenario              | Configuration  | Depiction of Vehicle  | # Trailers or Semi-trailers | # Axles | Gross Vehicle Weight (pounds)  | Roadway Networks   |
|-----------------------|--|---|-----------------------------|---------|--|--|
| <b>Control Single</b> | 5-axle vehicle tractor, 53 foot semitrailer (3-S2)     |    | 1                           | 5       | 80,000   | STAA <sup>1</sup> vehicle; has broad mobility rights on entire Interstate System and National Network including a significant portion of the NHS   |
| 1                     | 5-axle vehicle tractor, 53 foot semitrailer (3-S2)     |    | 1                           | 5       | 88,000   | Same as Above  |
| 2                     | 6-axle vehicle tractor, 53 foot semitrailer (3-S3)     |    | 1                           | 6       | 91,000   | Same as Above  |
| 3                     | 6-axle vehicle tractor, 53 foot semitrailer (3-S3)     |    | 1                           | 6       | 97,000   | Same as Above  |
| <b>Control Double</b> | Tractor plus two 28 or 28 ½ foot trailers (2-S1-2)     |    | 2                           | 5       | 80,000 maximum allowable weight<br>71,700 actual weight used for analysis <sup>2</sup> | Same as Above  |
| 4                     | Tractor plus twin 33 foot trailers (2-S1-2)            |    | 2                           | 5       | 80,000   | Same as Above  |
| 5                     | Tractor plus three 28 or 28 ½ foot trailers (2-S1-2-2) |   | 3                           | 7       | 105,500  | 74,500 mile roadway system made up of the Interstate System, approved routes in 17 western states allowing triples under ISTEA Freeze and certain four-lane PAS roads on east coast <sup>3</sup> |
| 6                     | Tractor plus three 28 or 28 ½ foot trailers (3-S2-2-2) |  | 3                           | 9       | 129,000  | Same as Scenario 5 <sup>3</sup>  |

<sup>1</sup>The STAA network is the National Network (NN) for the 3S-2 semitrailer (53') with an 80,000-lb. maximum GVW and the 2-S1-2 semitrailer/trailer (28.5') also with an 80,000 lbs. maximum GVW. The alternative truck configurations have the same access off the network as its control vehicle.

<sup>2</sup>The 80,000-lb. weight reflects the applicable Federal gross vehicle weight limit; a 71,700-lb. GVW was used in the study based on empirical findings generated through an inspection of the weigh-in-motion data used in the study.

<sup>3</sup>The triple network is 74,454 miles, which includes: the Interstate System, current Western States' triple network, and some four-lane highways (non-Interstate System) in the East. This network starts with the 2000 CTSW Study Triple Network and overlays the 2004 Western Uniformity Scenario Analysis, Triple Network in the Western States. There had been substantial stakeholder input on networks used in these previous USDOT studies and use of those provides a degree of consistency with the earlier studies. The triple configurations would have very limited access off this 74,454 mile network to reach terminals that are immediately adjacent to the triple network. It is assumed that the triple configurations would be used in LTL line-haul operations (terminal to terminal). The triple configurations would not have the same off network access as its control vehicle—2S-1-2, semitrailer/trailer (28.5'), 80,000 lbs. GVW. The 74,454 mile triple network includes: 23,993 mile network in the Western States (per the 2004 Western Uniformity Scenario Analysis, Triple Network), 50,461 miles in the Eastern States, and mileage in Western States that was not on the 2004 Western Uniformity Scenario Analysis, Triple Network but was in the 2000 CTSW Study, Triple Network (per the 2000 CTSW Study, Triple Network).

2) twin trailer combinations with 28 or 28.5-foot trailers that have a maximum GVW of 80,000 pounds. Scenario 4 examines a five-axle (2-S1-2) double trailer combination with 33-foot trailers with a maximum GVW of 80,000 pounds. Scenarios 5 and 6 examine triple-trailer combinations with 28.5-foot trailer lengths and maximum GVWs of 105,500 (2-S1-2-2) and 129,000 (3-S2-2-2) pounds, respectively. The five-axle twin trailer with 28.5-foot trailers (2-S1-2) is the control vehicle for Scenarios 4, 5, and 6 since it operates in much the same way as the scenario vehicles are expected to operate.

At this point it is important to note that for the purposes of the study the control double has an approved GVW of 80,000 pounds; however, the GVW used for the control double in the study is 71,700 pounds based on data collected from weigh-in motion (WIM)-equipped weight and inspection facilities. This is a more accurate representation of actual vehicle weights than the STAA authorized GVW, and using the WIM-derived GVW also allows for a more accurate representation of the impacts generated through the six scenarios.

### **Approach and Methodology**

The study team pursued three different approaches for examining the safety of the alternative configurations:

1. Crash-based analyses,
2. Analysis of vehicle stability and control, and
3. Analysis of safety inspection and violations data.

This three-pronged approach reflects the study team's conviction that using multiple types of analyses would provide a richer understanding of the safety performance of each alternative configuration, particularly when faced with data uncertainties associated with the crash data. Each of the three approaches has its own advantages and limitations, but all are designed to provide a broad picture of the potential safety implications of changes in the limitations of truck size and weight.

USDOT believes that the safety assessment should be conducted as much as possible with crash data reflecting actual operations on U.S. roads. The crash-based analyses used police-reported crash data in State crash files, crash information collected by trucking companies, and truck exposure data; for example, the travel demand situation, which was developed from several sources. The USDOT study team placed significant emphasis on analyzing crash data because they are "real-world data," and thus are most valid in nature. Acknowledged experts within the transportation safety discipline have stated in several publications on the topic that analyzing crash data and data on injuries and fatalities is, in fact, the definition of "safety analysis" (AASHTO, 2010; TRB, 2011).

## **Limitations**

The USDOT study team encountered several challenges while developing the safety information necessary to produce nationally representative estimates of changes in truck safety that are associated with the six alternative configuration scenarios:

- A lack of truck weight data for individual trucks in crash databases resulted in the State crash analyses comparing groups of control and alternative scenario trucks operating within State-specified maximum allowable GVW limits. As a result, the study team completed its comparison based on the number of axles on the vehicle rather than a comparison of vehicles at specific weights.
- Limitations in Annual Average Daily Traffic (AADT) and weigh-in-motion (WIM) data restricted the crash analysis to rural and urban Interstates.
- The lack of data elements in most State crash databases that would identify the configuration of a truck (e.g., 3-S2) limited the State crash analysis and the development of crash estimates to one State for Scenarios 2, 5, and 6 and two States for Scenario 3. Scenario 1 could not be analyzed due to the lack of truck weight records in the crash data and Scenario 4 could not be analyzed since that alternative truck configuration does not currently operate in the United States.
- Due to the limited number of States with suitable data, the analysis of crash rates cannot be extended to other States or be used to draw meaningful conclusions on a national basis. This Lack of weight data on State crash reports also made it impossible to complete a comparative assessment between trucks operating at and below current Federal size and weight limits and trucks that operate above those limits.
- Vehicle weight information reported by the States in the Federal Motor Carrier Administration's (FMCSA) Motor Carrier Management Information System (MCMIS) is not consistently reported, affecting the team's ability to categorize vehicles appropriately for the study.

Each of these challenges and their implications are discussed in detail in the crash analysis sections of **Chapter 2**.

## **Assumptions**

Additional information was obtained from States and fleets describing the exposure (VMT) of the alternative and control truck configurations. The exposure data from the States had to be supplemented with WIM data provided for the study by the Traffic Monitoring Team of Federal Highway Administration's (FHWA's) Office of Highway Policy Information. Some regression models relating crashes per mile to exposure were estimated; these results are reported in Section 2.3. Records of crashes from fleets were generally available, but the carriers did not consistently provide detailed route-level exposure data. As a result, only simplified analyses were undertaken with fleet data.

A set of vehicle stability and control analyses was designed to supplement the limited crash analysis performed in the Study. This analysis compared performance of control and alternative truck configurations in specific maneuvers. The maneuvers included low-speed off-tracking,

high-speed off-tracking, straight line stopping distance, brake in a curve, and avoidance maneuver. Performance metrics included stopping distance, maximum path deviation, off-tracking, rearward amplification and lateral load transfer ratio.

A third approach was undertaken in the Study to fill out the highway safety analysis. Records on violations and citations contained in FMCSA's MCMIS were inspected so as to determine the violation and citation rates for different truck configurations. As noted in the Limitations discussion, the gross combination weight field in MCMIS contains various vehicle weight values and so this aspect of the analysis was also very limited.

### **Results**

The analyses indicate that the safety implications of the alternative truck configurations vary across the array of vehicles examined. In general, for Scenarios 2 and 3, the six-axle configurations have higher crash rates than the five-axle tractor-semitrailer control configurations studied in the three States that fit the selection criteria. This is particularly evident in the two study States where six-axle trucks could run at weights close to the 97,000-lb. six-axle alternative truck configuration. Similar findings with respect to inspections and violations were observed. The six-axle configuration had higher violations, OOS rates, and brake-related violations per inspection when compared to the control group (i.e., the five-axle tractor semitrailer configurations at 80,000 lbs.). This differed from the six-axle configuration findings in the vehicle stability and control analysis.

The vehicle control and simulation analyses showed very marginal differences between the control and alternative truck configuration for the set of maneuvers evaluated. The differences between the crash and vehicle control and simulations findings could result from the fact that while crash rates reflect actual operations with various drivers in a variety of traffic, roadway and environmental conditions, the simulation-based analyses addressed specific controlled conditions, not reflecting that same range of operators or operating conditions. It was not possible to determine in this study what factors led to these differences. Further exploration is needed.

The Scenarios 5 and 6 findings involving triple-trailer alternative truck configurations also differed between the crash and vehicle stability and control methods. While no differences between triple-trailer and twin-trailer configurations was seen in the Scenario 6 Kansas Turnpike data, the crash rate analyses for Idaho (Scenario 5) indicated the triple-trailer crash rates to be lower than the twin-trailer configuration's rates. The vehicle stability and control analyses showed very marginal differences between the control and alternative configurations for the set of maneuvers evaluated. The Level 1 inspection summary data for safety inspections and violations showed that triple-trailer configurations tend to have lower violation rates than twin-trailer configurations. However, this is based on a very small sample size, and as a consequence, more rigorous statistics could not be conducted to explore this further.

Finally, in the scenario analyses, recall that the crash rates used in all scenario analyses were based on either one or two States. The use of rates from this limited number of States clearly raises significant questions concerning whether estimates could be considered nationally representative. **USDOT does not believe nationally representative estimates could be developed from the data.**

A major finding of this overall effort is that crash-based studies of truck size and weight using U.S. data are very difficult to conduct successfully. This is particularly true if the studies are based on the primary data sources in existence today – State crash files, State roadway inventory data, State AADT data and additional data on VMT for specific truck configurations. Fleet-supplied and MCMIS data were also found wanting.



**TABLE OF CONTENTS**

**Chapter 1 – Introduction ..... 1**

    1.1 Goals of the Safety and Truck Crash Comparative Analysis..... 2

    1.2 Current Truck Size and Weight Limits in the United States..... 4

**Chapter 2 – Crash Analysis ..... 8**

    2.1 Overview ..... 8

    2.2 Preparation and Review of Draft Safety Analysis Plan ..... 9

    2.3 State Data Crash Analyses ..... 11

    2.4 Route-Based Analysis ..... 38

    2.5 Fleet Analysis..... 39

    2.6 Summary of Crash Data Results ..... 45

**Chapter 3 – Analysis of Safety Vehicle Stability and Control ..... 51**

    3.1 Vehicle Stability and Control Scope ..... 51

    3.2 Vehicle Stability and Control Methodology ..... 51

    3.3 Vehicle Stability and Control Simulation Results..... 59

    3.4 Conclusions ..... 73

**Chapter 4 – Inspection And Violation Analysis ..... 76**

    4.1 Overview ..... 76

    4.2 Objectives..... 77

    4.3 Methodology ..... 77

    4.4 Data Used in Inspection and Violations Analysis..... 77

    4.5 Data Analysis ..... 81

    4.6 Out-of-service Violations Analysis..... 86

    4.7 Summary ..... 89

**Chapter 5 – Scenario Analysis..... 91**

**Chapter 6 – Conclusions..... 94**

**References..... 97**

**Appendix A: Revised Desk Scan..... 100**

**Appendix B. Safety Project Plan and Schedule ..... 156**

**Appendix C. Maneuvers for the Vehicle Stability and Control Analysis ..... 193**

**Appendix D. Models for the Vehicle Stability and Control Analysis..... 207**

**Appendix E. Results of the Vehicle Stability and Control Analysis..... 212**  
**Appendix F. Inspection and Violation Results..... 233**  
**Appendix G. Inspection Level Descriptions ..... 238**

**LIST OF FIGURES**

Figure 1: States Allowing the Operation of Longer Combination Vehicles (LCVs) on Some Portion of their Interstate System..... 5

Figure 2: Truck Involvements per Mile versus Truck Volume for Six-Axle Alternative Truck Configurations and Five-Axle Configurations in Michigan ..... 29

Figure 3: Truck Involvements per Mile versus Truck Volume for Six-Axle Alternative Truck Configurations and Five-Axle Controls in Washington..... 30

Figure 4: Vehicles Modeled – Single Trailer Combinations ..... 56

Figure 5: Vehicles Modeled – Multiple Trailer Combinations..... 57

Figure 6: Low-Speed Off-tracking Maneuver Simulates an Intersection..... 60

Figure 7: Off-tracking of the Drive and Trailer Axles Rises and Falls During the Maneuver. .... 61

Figure 8: Trailer Tracks to the Outside of the Curve Centerline in this High-Speed Off-tracking Illustration. .... 62

Figure 9: Off-tracking was Calculated by Taking the Difference in the Path Followed by the First and Final Axles. .... 62

Figure 10: Simulation of the Straight-line Braking Maneuver ..... 64

Figure 11: Position vs. Time (left) and Path Deviation vs. Time (right) of Control Single Vehicle as it Stops with Brake Failure on the Right Ends of the Two Drive Axles ..... 65

Figure 12: A Bird’s Eye View of Control Vehicle CS after Coming to Rest in the Brake-in-a-curve Maneuver with the ABS Disabled on the Drive Axles ..... 70

Figure 13: Paths of the Axle centerlines of the Control Double as it Executes the 12-ft. Avoidance Maneuver ..... 72

Figure 14: Off-tracking was Computed from the Axle Paths in the Previous Figure..... 73

Figure 15: Lateral Acceleration Time Histories of the Three Units of Control Vehicle CD in the 12-ft Lane Change..... 74

Figure 16: Vertical Tire Forces during the Lane Change Maneuver for the 12-ft Lane Change for Control Vehicle CD..... 75

Figure 17: Tractor Semitrailer Configurations ..... 79

Figure 18: Distribution of Driver Age for the 19 States in the Analyses (2008–2012)..... 85

**LIST OF TABLES**

Table 1: States Allowing Tractor Semitrailer Combinations with Maximum GVW Greater than 80,000 lbs. .... 3

Table 2: Truck Configuration and Weight Scenarios Analyzed in the 2014 CTSW Study ..... 6

Table 3: Criteria for a Preferred Crash Analysis vs. Current Real-World Situation ..... 8

Table 4: Crash Involvements and MVMT for Five- and Six-Axle Semitrailer Combinations in Washington, Idaho and Michigan ..... 20

Table 5: Crash Involvements and MVMT for Twin and Triple-trailer configurations (Idaho)State ..... 20

Table 6: Crash Involvements and MVMT for Semitrailers, Twin, and Triple-trailer configurations (Kansas Turnpike)..... 21

Table 7: VMT Proportions from Idaho, Michigan, and Washington ..... 22

Table 8: Crash Involvement Rates for Five-Axle and Six-Axle Semitrailers ..... 26

Table 9: Crash Involvement Rates for Twin Trailer and Triple-trailer configurations in Idaho (Scenario 5). ..... 26

Table 10: Crash Involvement Rates for Semitrailers, Twin Trailer, and Triple-trailer configurations for the Kansas Turnpike (Scenario 6) ..... 27

Table 11: Negative Binomial Models (Five-Axle and Six-Axle Semitrailers)..... 28

Table 12: Severity of Crashes Involving the Five-Axle Single Control and Six-Axle Scenario 2 Configurations on Interstates in Washington..... 32

Table 13: Severity of Crashes Involving the Five-Axle Single Control and the Six-Axle Scenario 3 Configurations on Interstates in Idaho ..... 32

Table 14: Severity of Crashes Involving the Five-Axle Single Control and the Six-Axle Scenario 3 Configurations on Interstates in Michigan..... 33

Table 15: Severity of Crashes Involving the Five-Axle Double Control and the Seven-Axle Scenario 5 Configurations on Interstates in Idaho ..... 34

Table 16: Severity of Crashes Involving the Five-Axle Double Control and the Nine-Axle Scenario 6 Configurations on Interstates the Kansas Turnpike ..... 34

Table 17: Results of Sequence-of-Events Analyses for Idaho and Michigan ..... 37

Table 18: Study Data/Model Accessibility and Data Custody Guidelines. .... 40

Table 19: Summary of Fleet Data Request ..... 41

Table 20: Severity of Interstate involvements for Twin-trailer and Triple-trailer Configurations from Fleet Data Including All Injury Crashes (Urban and Rural Combined)..... 44

Table 21: Severity of Interstate Involvements for Twin-trailer and Triple-trailer Configurations from Fleet Data Including Crashes with Injuries to Truck Occupants Only (Urban And Rural Combined)..... 45

Table 22: Non-truck Occupant Severity in Interstate Crashes Involving a Twin Trailer or Triple-trailer configuration with a Non-truck (Urban and Rural Combined). .... 45

Table 23: Summary of Crash-Data Analysis Findings Categorized by Scenario, Data Source and Analysis Type. .... 47

|  |    |
|--|----|
| Table 24: Simulated Vehicle Maneuvers.....   | 53 |
| Table 25: High-Speed Off-tracking Results .....  | 63 |
| Table 26: Straight-Line Braking Results .....  | 65 |
| Table 27: Five-axle Tractor-Semitrailer (Flat-bed) – Stopping Distances at 60 mph .....  | 67 |
| Table 28: Six-axle Tractor-Semitrailer (flat-bed) Stopping Distances at 60 mph (RSD Tractor – Large Front Brakes) .....                      | 68 |
| Table 29: Six-axle Tractor-Semitrailer (flatbed) – Stopping Distance at 60 mph (Non-RSD Tractor – Small Front Brakes).....                   | 68 |
| Table 30: Brake-in-a-Curve Results .....   | 69 |
| Table 31: Avoidance Maneuver Results.....  | 71 |
| Table 32: Summary of MCMIS Data From All 19 Study States for 2008 to 2012 .....  | 78 |
| Table 33: 2011 Estimated VMT in Million Miles .....  | 80 |
| Table 34: Number of Inspected Trucks from 2008 to 2012 for 19 States .....   | 81 |
| Table 35: Mean Number (Standard Deviation) of Noted Violations per Level 1 Inspection by Weight Threshold for All Truck Configurations ..... | 82 |
| Table 36: Mean Number (Standard Deviation) of Violations per Inspection by Truck Type.....   | 82 |
| Table 37: Mean Number (Standard Deviation) of Violations per Inspection by Truck and Weight .....  | 83 |
| Table 38: Explanatory Variables considered for the Logit models .....  | 83 |
| Table 39: Likelihood of a Violation Given a Level 1 Inspection – Alternative Tractor Semitrailer Configurations.....                         | 84 |
| Table 40: Mean Number (Standard Deviation) of OOS Violations per Inspection by Weight Threshold for All Truck Configurations. ....           | 86 |
| Table 41: Mean Number (Standard Deviation) of OOS Violations per Inspection by Truck Type .....  | 86 |
| Table 42: Mean (Standard Deviation) Company-Level Violations Per Inspection by Configuration and Weight.....                                 | 86 |
| Table 43: Likelihood of OOS Violation given a Level 1 Inspection – Alternative Tractor Semitrailer Configurations .....                      | 87 |
| Table 44: Mean Number (Standard Deviation) of Citations per Inspection by Weight Threshold for All Truck Configurations. ....                | 88 |
| Table 45: Mean Number (Standard Deviation) of Citations Per Inspection by Truck Type.....  | 88 |
| Table 46: Mean Number (Standard Deviation) of Citations per Inspection by Truck Configuration and Weight.....                                | 88 |
| Table 47: Likelihood of a Citation Given a Level 1 Inspection – Alternative Tractor Semitrailer Configurations.....                          | 89 |

**LIST OF ACRONYMS**

| <b>Acronym</b> | <b>Definition</b>   |
|----------------|---|
| AASHTO         | Association of State Highway and Transportation Officials |
| AC             | asphalt concrete  |
| ADT            | average daily traffic                                     |
| ADTT           | average daily truck traffic                               |
| CTSW           | comprehensive truck size and weight limits                |
| CVSA           | Commercial Vehicle Safety Alliance                        |
| ESALs          | equivalent single axle loads                              |
| FAF            | Freight Analysis Framework                                |
| FEA            | finite element analysis                                   |
| FHWA           | Federal Highway Administration                            |
| FMVSS          | Federal Motor Vehicle Safety Standard                     |
| GCW            | gross combined weight                                     |
| GVW            | gross vehicle weight                                      |
| LCC            | life cycle cost   |
| LCV            | longer combination vehicles                               |
| LEF            | load equivalence factors                                  |
| LTL            | less than truckload                                       |
| LTPP           | Long-Term Pavement Performance (program)                  |
| MEPDG          | Mechanistic Empirical Pavement Design Guide               |
| MCMIS          | Motor Carrier Management Information System               |
| NHTSA          | National Highway Traffic Safety Administration            |
| OGW            | operating gross weight                                    |
| ORNL           | Oak Ridge National Laboratory                             |
| PBBT           | Performance Based Brake Tests                             |
| PCE            | passenger car equivalents                                 |
| STAA           | Surface Transportation Assistance Act                     |
| STB            | Surface Transportation Board                              |
| USDOT          | US Department of Transportation                           |
| VMT            | vehicle miles traveled                                    |
| VIUS           | Vehicle Inventory and Use Survey                          |
| WIM            | weigh-in-motion   |

## CHAPTER 1 – INTRODUCTION

Provisions in MAP-21, the Moving Ahead for Progress in the 21st Century Act (P.L. 112-141), require the Secretary of Transportation, in consultation with each relevant State and other applicable Federal agencies, to commence a comprehensive truck size and weight limits study. Per the legislation:

*The study shall—*

*(1) provide data on accident frequency and evaluate factors related to accident risk of vehicles that operate with size and weight limits that are in excess of the Federal law and regulations in each State that allows vehicles to operate with size and weight limits that are in excess of the Federal law and regulations, or to operate under a Federal exemption or grandfather right, in comparison to vehicles that do not operate in excess of Federal law and regulations (other than vehicles with exemptions or grandfather rights);<sup>1</sup>*

*(2) evaluate the impacts to the infrastructure in each State that allows a vehicle to operate with size and weight limits that are in excess of the Federal law and regulations, or to operate under a Federal exemption or grandfather right, in comparison to vehicles that do not operate in excess of Federal law and regulations (other than vehicles with exemptions or grandfather rights), including—*

- (A) The cost and benefits of the impacts in dollars;*
- (B) the percentage of trucks operating in excess of the Federal size and weight limits; and*
- (C) the ability of each State to recover the cost for the impacts, or the benefits incurred;*

*(3) evaluate the frequency of violations in excess of the Federal size and weight law and regulations, the cost of the enforcement of the law and regulations, and the effectiveness of the enforcement methods;*

*(4) assess the impacts that vehicles that operate with size and weight limits in excess of the Federal law and regulations, or that operate under a Federal exemption or grandfather right, in comparison to vehicles that do not operate in excess of Federal law and regulations (other than vehicles with exemptions or grandfather rights), have on bridges, including the impacts resulting from the number of bridge loadings;*

---

<sup>1</sup> The Federal government began regulating truck size and weight in 1956 when the National Interstate and Defense Highways Act (Public Law 84-627), establishing the Interstate Highway System, was enacted. A state wishing to allow trucks with sizes and weights greater than the Federal limits was permitted to establish “grandfather” rights by submitting requests for exemption to the FHWA. During the 1960s and 1970s, most grandfather issues related to interpreting State laws in effect in 1956 were addressed, and so most grandfather rights have been in place for many decades. See USDOT *Comprehensive Truck Size and Weight Study, Volume 2*, “Chapter 2: Truck Size and Weight Limits – Evolution and Context,” FHWA-PL-00-029 (Washington, DC: FHWA, 2000), p. II-9.

*(5) compare and contrast the potential safety and infrastructure impacts of the current Federal law and regulations regarding truck size and weight limits in relation to—*

*(A) six-axle and other alternative configurations of tractor-trailers; and  
(B) where available, safety records of foreign nations with truck size and weight limits and tractor-trailer configurations that differ from the Federal law and regulations; and*

*(6) estimate—*

*(A) the extent to which freight would likely be diverted from other surface transportation modes to principal arterial routes and National Highway System intermodal connectors if alternative truck configuration is allowed to operate and the effect that any such diversion would have on other modes of transportation;  
(B) the effect that any such diversion would have on public safety, infrastructure, cost responsibilities, fuel efficiency, freight transportation costs, and the environment;  
(C) the effect on the transportation network of the United States that allowing alternative truck configuration to operate would have; and  
(D) whether allowing alternative truck configuration to operate would result in an increase or decrease in the total number of trucks operating on principal arterial routes and National Highway System intermodal connectors; and*

*(7) identify all Federal rules and regulations impacted by changes in truck size and weight limits.*

The key words in this legislation as they relate to safety in this directive are “differences in safety risks” and “potential safety ...impacts” of “alternative (truck) configurations.” The comparisons to be made are between trucks legally operating within and those operating in excess of Federal limits.

### **1.1 Goals of the Safety and Truck Crash Comparative Analysis**

The US Department of Transportation (USDOT) study team responded to this directive by using three different methods for examining the safety of these alternative truck configurations –

- (1) Crash-based comparative analyses,
- (2) Analysis of vehicle stability and control, and
- (3) Analysis of safety inspection and violations data.

These multiple approaches were designed to provide an understanding of the safety performance of the alternative truck configurations of interest, particularly when faced with uncertainties associated with the crash data. **From the outset, it must be understood that the lack of vehicle weight information on crash reports inhibits a robust comparative analysis of the crash implications associated with the alternative configurations assessed in this Study. Further, limitations on the availability of Weigh-in-Motion (WIM) data, primarily to Interstate**



**System roadways, inhibited the construction of adequate exposure data sets needed to assess the crash situations involving heavy trucks.** For these reasons, the three method approach was designed and followed to complete a crash assessment for inclusion in the Study.

Each of the three approaches that are listed has its own advantages and limitations, but the overall intent was to design a framework that provides a broad picture of the potential safety implications of the scenarios assessed in this Study.

Concerning crash analysis in particular, **Table 1** reveals examples of the broad range of gross vehicle weight (GVW) limits currently in place among the States. From a safety analysis point of view, this diversity in existing fleets is an advantageous situation. Conducting crash-based and violation-based analyses of different configurations requires these configurations to have operated on the Nation’s highways for a sufficient number of years to accumulate adequate exposure and adequate crash samples. The goal of the safety and truck crash comparative analysis is to take advantage of this diversity by developing measures of differences in safety for configurations that may be allowed to operate on more of the nation’s highways in the future.

An approach was constructed and followed to perform the assessment using, as much as possible, crash data reflecting actual operations on U.S. roads. The crash-based analyses were based on both police-reported crash data in State crash files, on crash information collected by trucking companies, and on truck exposure data developed from different sources. Significant emphasis was placed on analyzing crash data because they are “real-world data,” and thus the most valid in nature. Acknowledged leaders in the transportation safety discipline have stated in several publications on the topic that analyzing data on injuries and fatalities is, in fact, the definition of “safety analysis” (AASHTO, 2010; TRB, 2011).

**Table 1: States Allowing Tractor Semitrailer Combinations with Maximum GVW Greater than 80,000 lbs.**

| State         | GVW Limit (lbs.) |
|---------------|------------------|
| Idaho         | 89,500           |
| Kansas        | 120,000          |
| Kentucky      | 120,000          |
| Maine         | 100,000          |
| Michigan      | 104,000          |
| New Hampshire | 99,000           |
| New Mexico    | 86,400           |
| New York      | 107,000          |
| Oregon        | 100,000          |
| Utah          | 89,000           |
| Vermont       | 100,000          |
| Washington    | 92,000           |

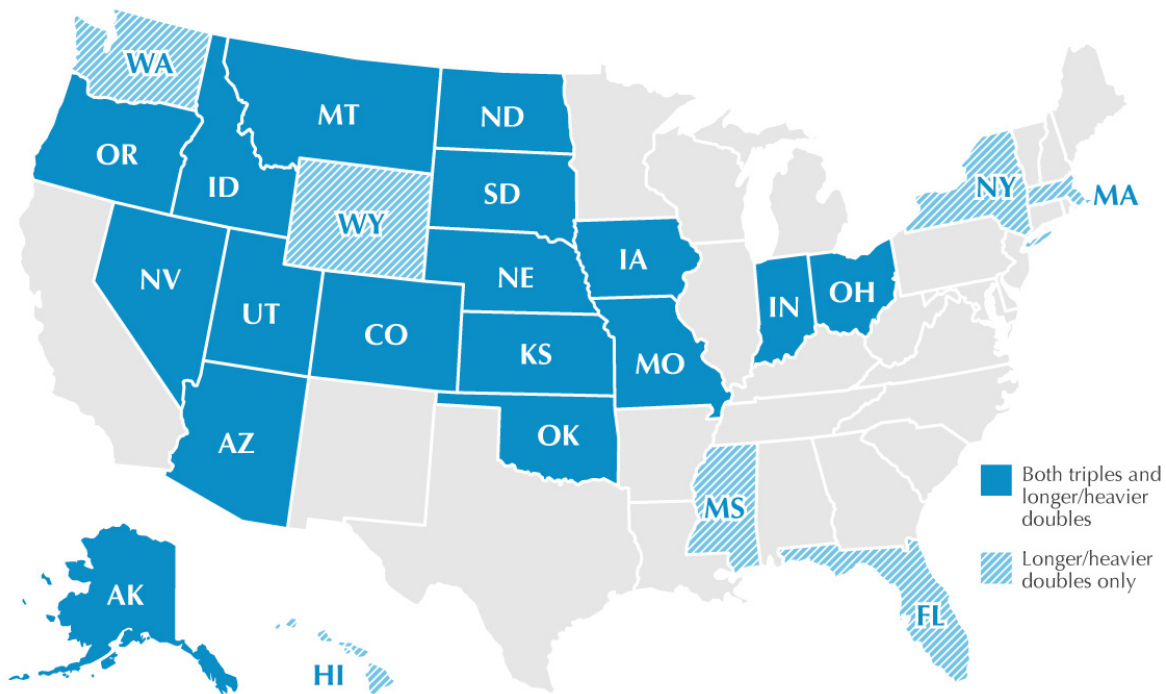
Note: Vehicles are allowed on at least some Interstate roadways.

Source: Information collected through State interviews with commercial vehicle safety program personnel.

Truck safety studies that depend on crash analyses present several specific challenges. Problems exist in defining specific truck configurations based on data available on police crash report forms. Because of limited VMT, and thus low exposure, there are small samples of crashes for some truck configuration of interest (specifically for triple-trailer configurations). The development of accurate truck travel estimates by configuration type and roadway type is difficult. **Representative crash analysis results for the nation could not be developed for this Study due to these data limitations.** Vehicle stability and control software allows a user to analyze specific maneuvers at specific weights and speeds for specific truck configurations; however, there is difficulty in determining the prevalence of these specific combinations of maneuver, weight, and speed by configuration in actual operations. Truck safety inspections and violation data does enable researchers to explore differences in safety-related violations between specific alternative and control configurations, and differences found in violation rates cannot be readily converted into predicted differences in crash rates. However, even with their limitations, each method provides important information on truck safety, and the combination of findings from all three, particularly to the extent that they are in alignment, provides even more validity to the results.

## **1.2 Current Truck Size and Weight Limits in the United States**

The MAP-21 directive notes that safety comparisons are to be made between trucks legally operating within and those operating in excess of current Federal limits. At first glance, this would imply that the comparisons are between “legal trucks” (including those operating with a valid State-issued overweight permit) and “illegal trucks” (i.e., overweight and oversize trucks operating without a valid permit). The current Federal gross vehicle weight (GVW) limit for five-axle tractors semitrailers and for five-axle tractors with twin semitrailers is 80,000 lbs. on the Interstate system. Current restrictions on trailer length allow a tractor to pull a 48-ft. semitrailer while travelling on the National Network, although a number of States allow the operation of tractor pulling a 53-ft semitrailer, which is considered the industry standard length. A twin-trailer configuration (i.e., a tractor and two 28.5-ft. “pups”) with a gross weight of 80,000 lb. or less is allowed on the National Network. However, there are numerous highways where trucks that are in excess of these Federal limits are legally operating due to exemptions found in Federal regulations and grandfathered State limits. **Table 1** above provides examples of States allowing a tractor/semitrailer to operate above the 80,000-lb. limit. Longer combination vehicles (LCV), including triple-trailer configurations and double-trailer configurations heavier and longer than twins, operate in 17 States, mostly in the mid-western and western parts of the country (see **Figure 1**). The maximum GVW limits for these LCVs vary by State, but all exceed the 80,000-lb. Federal limit.




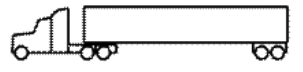


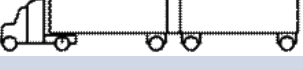

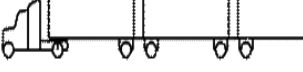
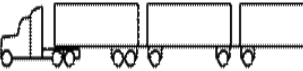
**Figure 1: States Allowing the Operation of Longer Combination Vehicles (LCVs) on Some Portion of their Interstate System**

*Source: Title 23 Code of Federal Regulations, Part 658, Appendix C*

Given the large diversity of configurations operating now, one question that had to be addressed was how to assess the impacts of trucks operating at and below current Federal size and weight limits compared to trucks operating above those limits. Another question that had to be addressed was how to assess the impacts that national operation of vehicles at sizes and weights above the current limits would have on highway safety, crash rates, highway infrastructure, the delivery of truck size and weight enforcement, the operation of other modes in the movement of freight.

Another important question was which configurations to use in the study. The MAP-21 language does not specify study configurations specifically, only referring to “six-axle and other configurations.” As a result, using inputs from the public, trucking companies, truck experts, advocacy groups and a variety of other stakeholders, USDOT defined six alternative truck study scenarios as shown in **Table 2**. Each scenario includes an alternative truck configuration with the network it will operate on and the access assumptions off of that network.

**Table 2: Truck Configuration and Weight Scenarios Analyzed in the 2014 CTSW Study**

| Scenario              | Configuration  | Depiction of Vehicle  | # Trailers or Semi-trailers | # Axles | Gross Vehicle Weight (pounds)  | Roadway Networks   |
|-----------------------|--|---|-----------------------------|---------|--|--|
| <b>Control Single</b> | 5-axle vehicle tractor, 53 foot semitrailer (3-S2)     |    | 1                           | 5       | 80,000   | STAA <sup>1</sup> vehicle; has broad mobility rights on entire Interstate System and National Network including a significant portion of the NHS   |
| 1                     | 5-axle vehicle tractor, 53 foot semitrailer (3-S2)     |    | 1                           | 5       | 88,000   | Same as Above  |
| 2                     | 6-axle vehicle tractor, 53 foot semitrailer (3-S3)     |    | 1                           | 6       | 91,000   | Same as Above  |
| 3                     | 6-axle vehicle tractor, 53 foot semitrailer (3-S3)     |    | 1                           | 6       | 97,000   | Same as Above  |
| <b>Control Double</b> | Tractor plus two 28 or 28 ½ foot trailers (2-S1-2)     |    | 2                           | 5       | 80,000 maximum allowable weight<br>71,700 actual weight used for analysis <sup>2</sup> | Same as Above  |
| 4                     | Tractor plus twin 33 foot trailers (2-S1-2)            |    | 2                           | 5       | 80,000   | Same as Above  |
| 5                     | Tractor plus three 28 or 28 ½ foot trailers (2-S1-2-2) |    | 3                           | 7       | 105,500  | 74,500 mile roadway system made up of the Interstate System, approved routes in 17 western states allowing triples under ISTEA Freeze and certain four-lane PAS roads on east coast <sup>3</sup> |
| 6                     | Tractor plus three 28 or 28 ½ foot trailers (3-S2-2-2) |  | 3                           | 9       | 129,000  | Same as Scenario 5 <sup>3</sup>  |

<sup>1</sup> The STAA network is the National Network (NN) for the 3S-2 semitrailer (53') with an 80,000-lb. maximum GVW and the 2-S1-2 semitrailer/trailer (28.5') also with an 80,000 lbs. maximum GVW. The alternative truck configurations have the same access off the network as its control vehicle.

<sup>2</sup> The 80,000 pound weight reflects the applicable Federal gross vehicle weight limit; a 71,700 gross vehicle weight was used in the study based on empirical findings generated through an inspection of the weigh-in-motion data used in the study.

<sup>3</sup> The triple network is 74,454 miles, which includes the Interstate System, current Western States' triple network, and some four-lane highways (non-Interstate System) in the East. This network starts with the 2000 CTSW Study Triple Network and overlays the 2004 Western Uniformity Scenario Analysis, Triple Network in the Western States. There had been substantial stakeholder input on networks used in these previous USDOT studies and use of those provides a degree of consistency with the earlier studies. The triple configurations would have very limited access off this 74,454 mile network to reach terminals that are immediately adjacent to the triple network. It is assumed that the triple configurations would be used in LTL line-haul operations (terminal to terminal). The triple configurations would not have the same off network access as its control vehicle—2S-1-2, semitrailer/trailer (28.5'), 80,000 lbs. GVW. The 74,454 mile triple network includes: 23,993 mile network in the Western States (per the 2004 Western Uniformity Scenario Analysis, Triple Network), 50,461 miles in the Eastern States, and mileage in Western States that was not on the 2004 Western Uniformity Scenario Analysis, Triple Network but was in the 2000 CTSW Study, Triple Network (per the 2000 CTSW Study, Triple Network).

In general, each scenario's alternative truck configuration uses its respective control vehicle's nationwide network and access rules with the exception of the triple truck configuration, which has a restricted network and access rules (see **Table 2**). The numbers and letter combinations for each configuration refer to the number of axles on the tractor followed by the number on the semitrailer, followed by the number of axles on each additional trailer. So the "triple" configuration in Scenario 6 (3-S2-2-2) has three axles on the tractor, two axles on the semitrailer and two axles on each of the two additional trailers.

Notice that the desired alternative vehicle weights in **Table 2** do not match precisely to the weight limits currently operating in the United States, as shown in **Table 1**. This is one indication of the practical difficulties the study team faced in categorizing crash involvements with respect to weight limits. The configurations determined by USDOT and outlined in **Table 2** imply a desired level of precision in comparisons of crash involvements by truck configuration and weight that could not be met solely by using available crash data. In order to address this, the study team found it necessary to develop computer simulations of vehicle stability and control descriptors and to analyze violations and citations from roadside truck inspections.

**Table 2**, column 3 identifies the control or reference vehicle to which each alternative truck configuration is compared. There are two control vehicles that do not exceed current limits (i.e., 3-S2, 80,000 lb. and Twin 28.5, 80,000 lb.). Alternative tractor/semitrailer configurations in Scenarios 1-3 are to be compared to the 3-S2, 80,000 lb. tractor/semitrailer and the alternative double trailer and triple-trailer configurations in Scenarios 4-6 are to be compared to the 2-S1-2, tractor/semitrailer/trailer (28.5'), 80,000 lb. "twins" configuration. Each of these configurations realize broad mobility privileges for travel on the National Network as defined in 23 CFR Part 658 Appendix A.

Analyses using crash and violation data cannot be conducted at all for two of the scenarios. Scenario 1 crash analyses cannot be conducted because there is no truck weight information in State crash data that would allow the separation of the five-axle, 88,000-lb. alternative configuration from the five-axle, 80,000-lb. control vehicle. In addition, the analysis of the Scenario 4 five-axle, 80,000-lb. configuration could not be conducted using crash or violations data since this configuration is not currently operating in the United States. However, both of these alternative truck configurations (and all four other alternative truck configurations) were analyzed in the vehicle stability and control analyses.

The remainder of this report provides details and findings of the three major safety analysis methods – (1) crash-based analyses, (2) analysis of vehicle stability and control through computer simulation, and (3) analysis of safety inspection and violations data.

CHAPTER 2 - CRASH ANALYSIS

**2.1 Overview**

Based on information found through a search of existing literature (i.e., desk scan), conducting crash-based analyses of truck safety, particularly for specific alternative truck configurations like those defined in the scenarios for this project, is difficult. The first column of **Table 3** shows what might be considered preferred criteria for a crash analysis of the alternative configurations of interest. The second column indicates the current real-world situation. This table concisely describes the challenges faced in attempting to use crash data that reflects actual highway operations within the safety study.

**Table 3: Criteria for a Preferred Crash Analysis vs. Current Real-World Situation**

| Preferred Crash Analysis Criteria  | Real-World Situation  |
|--|---|
| Availability of suitable truck crash and exposure data from <i>US sources</i> in order to overcome possible differences between the United States and other nations (e.g., Canada) in operations, drivers, enforcement, weather, etc.  | Crash data exist in both State files and in carrier files in the United States. WIM systems in most States provide data that can be used to develop exposure estimates for specific alternative truck configurations (with limitations).  |
| Availability of truck crash and exposure data within States or trucking companies which allow the analysis of total truck crashes rather than just fatal crashes.  | Crash data for all crash severities is available in State and carrier files. Trucking companies provided limited exposure data.   |
| Each alternative truck configuration of interest has operated for a sufficient past period in a given State or within a given company to generate adequate samples of exposure and thus crash data.  | Except for the 33-ft twin configuration (Scenario 4), all configurations of interest have operated in one or more States by one or more carriers for a number of years. However, crash samples are still small for some configurations.   |
| Each State or fleet in which an alternative operates also allows the operation of the desired control truck configuration on the same route sections (e.g., a State allowing a six-axle, 97,000-lb., 53-ft tractor-semitrailer configuration would also allow a five-axle, 80,000-lb., 53-ft tractor-semitrailer configuration (as opposed to a 48-ft configuration)). | The five-axle twin (28.5 ft.) control double configuration operates on the NN in all States allowing triple configurations. However, carriers that are allowed to use triple-trailer configurations use very few twins, particularly on routes where triple configurations operate. This ostensibly rules out use of the matched-pair analysis for fleet triple configurations. |
| Each alternative and control truck configuration operates in several States or in several fleets so that the findings from each can be compared and combined, supporting efforts to prepare nationally representative results.   | Different States allow different combinations of alternative and control truck configurations. This limits the number of potential States where a given pair can be analyzed.   |
| Truck crash data contains sufficient information to clearly define given alternative and control truck configurations (e.g., a police or trucking company crash form contains variables on number of trailers, number of axles, GVW, and trailer length).  | While the number of trailers is included in most State truck crash data, few States include number of axles, and none include information on GVW. Very few contain information on trailer length. GVW is not consistently tracked in fleet-based crash reports.   |

| <b>Preferred Crash Analysis Criteria</b>   | <b>Real-World Situation</b>  |
|--|--|
| Truck exposure data for each alternative and control configuration is available for individual route segments to allow combination with segment-specific data concerning total vehicle miles of travel (e.g., total AADT). The data are needed for both Interstate and non-Interstate roads. | Due to the limited number of WIM stations in any State, with the majority of these sites located on Interstate System segments, and the nature of the data collected (e.g., one-lane only), exposure data for specific vehicle configurations cannot be developed for individual route segments, only for entire functional classes. |

The safety assessment completed for this Study was designed to incorporate as many of these criteria as possible while recognizing that not all could be met. To conduct the best possible study, three different methodologies were attempted –

- (1) A crash-rate comparison study based on State crash data and exposure data from both the State and from supplemental WIM-based exposure data;
- (2) A route-based method which compares the total crash rate of a specific route where a specific alternative truck configuration is operated (e.g., triple-trailer configurations on certain Interstate routes) to a similar route in the same State that does not allow the configuration to operate; and
- (3) A fleet-based method where a specific alternative truck configuration and its control truck both operate on the same roadways using data from participating carriers.

The actual implementation of these methods, with practical constraints, is described in detail in the following narrative.

## **2.2 Preparation and Review of Draft Safety Analysis Plan**

Based on the desk scan and the project requirements, the USDOT study team developed an approach to framing a draft safety analysis plan that introduces these three methods. A thread running through the literature was the difficulty expected in conducting such crash analyses. Of all the studies reviewed, four stand out as perhaps the most important:

- A TRB study of the Turner Proposal (TRB, 1990b)
- A TRB review of Truck Size and Weight Limits (TRB, 2002);
- The U.S. Department of Transportation (USDOT) Comprehensive Truck Size and Weight Study 2000 (2000 CTSW Study) (FHWA, 2000a); and
- The Western Uniformity Scenario (USDOT, 2004).

It is notable that while all four cited safety as one of the primary concerns in studies of truck size and weight, and while all reviewed past crash-based safety studies, only one actually conducted a crash-based study. Three of the four cited or used computer simulation of truck performance characteristics as the principle safety analysis technique.

The team’s review of the literature also indicated that while there have been a large number of research studies related to truck size and weight, much of the past research compared tractor-semitrailer configurations to twin-trailer configurations. Many of the studies also involved

analyses of only fatal crashes. In contrast, the current study examines specific alternative truck configurations within the larger single- and double-trailer configuration classes and estimates total truck crashes rather than fatal crashes.

The difficulty in studying actual truck weight in crash-based analyses was noted in a TRB study (TRB, 2002), which indicated that the safety implications of GVW had been studied in one prior research effort (Campbell, et al., 1988). The TRB report went on to cite the difficulties in drawing sound conclusions from the data available in that study. While the current study also does not analyze individual truck GVWs due to the lack of such data on State crash forms, the choice of States used in this study was based on the maximum GVW limit allowed in a given State for both the specific alternative truck and control truck configurations.

The desk scan findings emphasized the importance of controlling roadway type or class in the analyses (e.g., Interstate vs. non-Interstate roads). As noted by Campbell, et al. (1988), different truck configurations have different patterns of travel across road types, making simple comparisons of crash rates across multiple road types misleading. In this current study, the comparisons were restricted to crashes within two road classifications – urban and rural Interstates. As noted in **Table 3**, most WIM stations are located on Interstate System segments. Developing non-Interstate System NHS roadway exposure data was limited by this factor.

A consistent theme in past research on size and weight issues has been the limitations of crash and exposure data. Most crash data systems are inadequate in terms of allowing precise identification of longer or heavier trucks. No State crash data system includes the operating weight of trucks at the time of the crash. Most do not include lengths of either individual units or combination lengths, and very few include axle counts. Exposure data are equally problematic. The only truck-configuration exposure data collected by State departments of transportation (DOT) is vehicle classification data based on FHWA's 13-level classification system. This system provides categories defined by axles and number of trailers, but includes twin-trailer configuration in up to three classes and consolidates triple-trailer configurations and all other LCVs into one class. For that reason, this current study used WIM data in the development of exposure for specific alternative and control truck configurations, as suggested by various authors (Campbell, Blower et al. 1996; Abdel-Rahim, Berrio-Gonzales et al. 2006b; Montufar, Regehr et al. 2007; Regehr, Montufar et al. 2009).

Finally, there is evidence from Canada and other nations that long combination vehicles (LCVs) in general may experience very low crash rates if stringent restrictions are placed on drivers, routes, bad-weather operation, truck configuration equipment (e.g., dollies), truck components (e.g., brakes) and other safety-related factors (Woodrooffe, Anderson et al. 2004). This current study is being conducted without such stringent restrictions and is based on actual data from the States.

A significant part of the study project plan examined the choice of State databases and potential fleet databases that might be used in the effort. To gather additional commentary, the plan was presented at two public outreach sessions. Responses to comments received at these sessions resulted in modifications to the plan.



The effect of heavier and longer vehicle configurations on roadside hardware and barriers was also investigated in the study. Currently there is no testing protocol in place that supports evaluating the performance of roadside safety appurtenances when trucks weighing more than 80,000 pounds crash into them. The study team identified the steps needed to establish such a crash-test protocol and the cost of developing the framework for such evaluations, which are addressed later in this Report.

The challenge of distinguishing between legal or illegal overloading was considered early on in the process. The information included on the crash data records does not indicate whether the truck involved was operating at a legal weight, above the legal weight but with a legally issued State over-weight permit, or above the legal weight operating without a permit (violators). As a result, the type of analysis initially considered, while desirable, was found not to be feasible.

### **2.3 State Data Crash Analyses**

The goal of the State crash analysis is to assess crashes per mile of truck travel for trucks operating at or below current Federal limits as compared with crashes among those vehicles operating above existing Federal limits in six alternative truck configuration scenarios. The basic method involved the following activities:

- Identify the States where each truck configuration of interest to the study (i.e., trucks operating at and below Federal limits and each of the six alternative configurations) has accumulated adequate annual VMT for a sufficient number of years to accumulate a reasonable sample size of crashes (i.e., determine which alternative truck configurations have accumulated significant exposure in which States).
- Identify the subset of these States in which a) each alternative configuration and the control configurations can be identified through the use of variables in the existing crash data, and b) the allowable GVW limits for the alternative and control configurations (e.g., the maximum allowable GVW for a triple-trailer configuration) match those in **Table 2** above.
- Obtain total AADT and other inventory variables for each route section to be studied.
- Obtain WIM data for the routes to be studied and combine it with the AADT data to develop VMT estimates for each alternative and control configuration on each route section.
- Estimate rates and safety performance functions to compare the safety of baseline trucks and alternative trucks.

#### ***Choice of State Data Bases***

A critical component of this method was the choice of States to be used in analyzing each of the alternative vehicles. Since the State-choice decisions are based on different data inputs for analyzing Scenario 2 and 3 and Scenarios 5 and 6, the following section provides details for each.

### Analysis of Single Semitrailer Configurations

This analysis involves comparing the crash experience for Scenarios 2 and 3. The alternative truck configurations both have three axles on the tractor, three on the trailer, and a GVW limit of either 91,000 lbs. or 97,000 lbs. The control vehicle is the standard tractor/semitrailer combination with the three axles on the tractor, two on the trailer, and an 80,000 lb. GVW limit. All three vehicles have a 53 ft. semitrailer. (Note that 53-ft. trailers now operate in all States, so that criteria will be met regardless of the States chosen.) Paralleling the analysis of triple-trailer configurations, the primary criteria for including a State in the analysis are:

- An 80,000 lb. GVW limit for the control vehicle.
- Either a 91,000 lb. or 97,000 lb. GVW limit for the alternative truck configurations. (Note again that because there is no weight data on crash forms, this decision had to be based on the GVW limit for the roads in the State being investigated.)
- Adequate VMT for both the alternative truck configuration semitrailers and the control vehicle. (Note that there will be adequate VMT for the control vehicle in all States.)
- The alternative truck configuration semitrailers can be distinguished from the control vehicle in the crash data using number of trailers and number of total axles. Note that the assumption here is that a six-axle semitrailer combination can be considered a 3-S3 configuration. Only States where the six-axle configuration can be identified and where the GVW limit is higher than 80,000 lb. were considered for this analysis.

The inputs to the decision concerning which States would be used in this analysis were from the following sources:

- A table of “Grandfathered Weights Allowed by States.” The information are based on 23 CFR Part 658 Appendix C.
- A table of “State Weight Exemptions (As of March 2008).” The data are based on U.S. Code Title 23 Section 127.
- GVW limits for alternative truck configurations included in a table of “CTSW Heavies (grandfathered over 80,000 lb.) allowed on Interstate System.” This table includes States recommended by FHWA personnel and the Commercial Vehicle Safety Alliance (CVSA) for the *Volume II: Compliance Comparative Analysis*. It was updated a number of times during the study period, with the last update being in April, 2014.
- VMT data from 2008 for each of the 25 vehicle configurations within the 14 functional classes within each State. The classes of interest in this analysis are the six-axle alternative truck configurations in Scenarios 2 and 3 and the five-axle control single configuration.
- Presence of “number of trailers” and “number of total axles” variables on State crash report forms. This information was compiled through searches for crash report forms from publicly available sources available on the Internet.

The USDOT study team extracted data for an initial group of 13 States allowing use of alternative truck configurations. The team looked for the presence and level of VMT on Interstate highways for the alternative truck configurations in the 2008 data. The team also looked for the presence of the needed trailer-count and axle-count crash form variables and the stated GVW limits for both the Scenario 2 and 3 configurations and the control single truck.

Note that the final input – the GVW limits – changed as the study progressed based on more detailed data obtained in the *Volume II: Compliance Comparative Analysis* area of the 2014 CTSW Study for each of the candidate States.

While none of the States allowing the alternative truck configurations fit all of the desired criteria, three States provided data that appeared to be sufficient: Idaho, Michigan, and Washington.

- Idaho – The 2008 VMT data showed mid-level VMT for the alternative truck configurations when compared to the VMT for the alternative truck configurations in other potential States. Axle-count data are present on the crash report form for 2010 and earlier, allowing the separation of the six-axle alternative configuration from the five-axle control configuration. The maximum GVW for the six-axle alternative configuration is 105,500 lbs. rather than the 97,000-lb. target for Scenario 3, and the max GVW for the five-axle control vehicle is the 80,000-lb. target.
- Michigan – The 2008 VMT data showed mid-level VMT for the alternative truck configurations when compared to the VMT for the alternative truck configurations in other potential States. Axle-count data are present on the crash report form for 2008 – 2012, allowing the separation of the six-axle alternative configuration from the five-axle control configuration. The maximum GVW for the six-axle alternative configuration is 105,500 lbs. rather than the 97,000-lb. target for Scenario 3, and the maximum GVW for the five-axle control vehicle is 86,000 lbs. rather than the 80,000-lb. target. However, it was determined that these limits were close enough to provide meaningful data, particularly given the limited number of potential analysis States.
- Washington – The 2008 VMT data showed an adequate level of VMT for both six-axle and seven-axle semi-trailer combinations when compared to other potential States. Axle count data are present on the State crash report form for 2008-2012, allowing the separation of the six-axle alternative configuration from the five-axle control configuration. Information collected for the *Volume II: Compliance Comparative Analysis* from WSDOT staff indicated that the maximum GVW for the six-axle configuration would be approximately 92,000 lbs., very close to the 91,000-lb. target for Scenario 2. The maximum GVW limit for the five-axle control semitrailer is 80,000-lb., the target value.

### Analysis of Double and Triple-trailer configurations

The inputs to the decision concerning which States were to be used to compare the control double twin to the Scenario 5 and 6 triple configurations were from the following sources:

- List of States allowing travel by triple-trailer configurations. The table entitled “Tractor-trailer-trailer Combinations in Operation” under “ISTEA Freeze” was based on data extracted from the Title 23 Code of Federal Regulations, Part 658, Appendix C. For each of the 17 States allowing triple-trailer configurations, the table provided information on “Allowable Length - Cargo Carrying Units (feet)” and “Gross Vehicle Weight Limit (pounds).”

- GVW limits for triple-trailer configurations included in a table of “CTSW Heavy Trucks (grandfathered over 80,000 pounds) allowed on Interstate System.” This table was developed by the team working on the *Volume II: Compliance Comparative Analysis* and includes States recommended by FHWA personnel and the Commercial Vehicle Safety Alliance (CVSA) for the compliance study. It was updated a number of times during the study period, the last update being on January 21, 2014.
- VMT data from 2008 for each of the 25 vehicle configurations within 14 functional classes for each State. These data were developed by the study team working on the *Volume II: Modal Shift Comparative Analysis* effort.
- Presence of “number of trailers” and “number of total axles” variables on State crash report forms. This information was compiled by the safety team through searches for crash report forms from internet sources.

An initial group of 17 States allowing use of triple-trailer configurations was extracted from these data sources and analyzed in the original study plan. Since a sufficient sample size for the VMT of triple-trailer configurations was critical to this analysis, the 2008 VMT data were searched to identify triple-trailer configurations States with VMT for either or both seven-axle triple and triples with eight or more axles. The triple-trailer configuration VMT levels for each State were then categorized as very low, low, medium, or high by functional class was produced to conduct an analysis on NHS roadways. Further, the purpose of including the low and very low volume categories was to conduct assessments on roadway segments representative of local roadways. In addition, for these same triple-trailer configuration States, similar VMT information was extracted for each double-trailer category (i.e., VMT for two-trailer configurations with five, six, seven and eight-axles) since the first one is the potential control vehicle. The study team felt that using 2008 VMT was suitable since the analysis includes crash data from 2008 – 2012, and these data verified that the triple-trailer configurations were in operation for the full period.

Finally, information on the presence of crash form variables related to number of trailers and number of axles were added for each State with triple-trailer configurations. Again, the axle count information is critical to distinguish between data for the control double configuration from data for the heavier double-trailer configurations like the Rocky Mountain Doubles (twenty-eight and one-half foot trailer or semitrailer hitched to a full semitrailer) and Turnpike Doubles (twin full length semitrailer or semitrailer-trailer combination). The study team also initially searched for crash data variables related to operating weight to allow for even better definition of the alternative triple-trailer configurations and separation of the twins from other double-trailer configurations. However, none of the States has actual operating weight information on the crash report forms. For that reason, the study team performed the analysis of the crash experience of the two triple-trailer configurations’ GVW classes by using States with different GVW limits for these combination vehicles. That is, the sample of States to be studied included both those with a 105,500 lb. GVW limit and those with a 129,000 lb. GVW limit for triple-trailer configurations.

Use of maximum GVW limits rather than the missing individual truck weights means that the crash analyses in this study are not comparisons of individual trucks above and below 80,000-lbs., but rather are comparisons of groups of trucks that could potentially run at that weight and

configuration (e.g., the comparison of the triple-trailer group with a maximum GVW limit of 105,500 lb with a twin-trailer group with a maximum GVW limit of 80,000 lb).

None of the States allowing triple-trailer configurations fit all three criteria – high VMT for triple-trailer configurations, the ability to limit the control double group to the twin-trailer configuration, and a GVW limit that matches the two scenario targets of 105,500 lbs. and 129,000 lbs. Initially, five States had at least moderate potential for analysis: Idaho and Oregon for the 105,500 lb. triple-trailer configurations and Kansas (Turnpike only), Nevada and Utah for 129,000 lb. triple-trailer configurations.

The lists of candidate States were further reduced as the research team working on the *Volume II: Compliance Comparative Analysis* effort uncovered additional information concerning actual GVW limits. Oregon was dropped from the 105,500-lb. group and Nevada and Utah were dropped from the 129,000-lb. group because their crash forms did not include an axle-count variable. This made it impossible to differentiate between the different double-trailer configurations in the crash data. This was critical since all three States allow longer and heavier double-trailer combinations (e.g., Rocky Mountain Doubles and Turnpike Doubles). The lighter five- and six-axle double-trailer configurations (the most likely twins groups) could not be separated from these heavier eight- and nine-axle double-trailer configurations (for which there was significant 2008 VMT), making the definition of a suitable reference group impossible.

These reductions resulted in two analysis States – Idaho for the 105,500 lb. triple-trailer configurations (Scenario 5) and Kansas for the 129,000 lb.-triple-trailer configurations (Scenario 6).

In the case of Idaho, while showing moderate triple-trailer configurations VMT in 2008 compared to other States that allow triple configurations to operate, the Idaho crash form contained information on the number of axles on the truck up through 2010. (The variable was removed from the crash form in 2011.) This allowed the isolation of the crashes for the five- and six-axle double-trailer configurations (likely twins) from the double-trailer configurations with more axles. While the maximum GVW limit for double-trailer configurations is 105,500 lbs., information collected by the *Volume II: Compliance Comparative Analysis* study team from Idaho staff indicates that the realistic maximum for twins is 80,000 lbs., the desired GVW for the control vehicle. The GVW limit for triple-trailer configurations is 105,500 lbs., the target GVW.

For Kansas, the initial investigation showed some triple-trailer configuration VMT on rural Interstates, an 80,000-lb. maximum GVW for double-trailer trucks, and axle-count data on the crash form to allow the isolation of the five- and six-axle (presumed) twin trailer group. The maximum GVW limit for triple-trailer configurations is 120,000 lbs., which is close to but somewhat lower than the 129,000-lb. limit desired. It was later learned that triple-trailer configurations flow was primarily on the Kansas Turnpike with some flow on limited sections of other connecting Interstates. As described below, some turnpike exposure data were later obtained from both the Turnpike Authority and from the Kansas DOT.

Crash data, roadway inventory, and AADT data for Interstate roadways were obtained from the State DOTs in both Idaho and Kansas. Exposure data for the alternative and control trucks on the Kansas Turnpike were still missing since there were no WIM data collected on toll roads. The

Kansas Turnpike Authority supplied average daily counts of trips between pairs of toll stations (e.g., toll station 1 and toll station 9) categorized into axle-count classes. Individual counts for vehicles with seven, eight and nine or more axles were included. Safety team staff developed accumulated counts between each pair of mile-posted stations, resulting in AADT estimates for each axle category. Additional data were also acquired from the Kansas DOT Planning Department, which included 13-bin counts for five locations along the Turnpike. A method was developed to combine the two data sets to estimate twin configuration AADT. Unfortunately, the data do not allow the seven, eight, and nine axle counts to be separated into counts for triple-trailer configurations vs. non-triple trailer trucks. Kansas Turnpike Authority staff was interviewed to determine if they could provide estimates of the percentage of triple-trailer configurations within the seven, eight, and nine or more axle categories; they could not. Thus, the triple-trailer configurations estimates were produced from WIM data that were collected on Interstate 35 in the adjacent State of Oklahoma. This is the same Interstate that forms the southern-most leg of the Kansas Turnpike. The percentage of seven-and eight-axle trucks that were classified as triple-trailer configurations in the Oklahoma data were applied to the total seven- and eight-axle vehicles on the Kansas Turnpike to arrive at the estimated AADT values for seven- and eight-axle triple-trailer configurations on the Turnpike.

Similarly, the Indiana Toll Road (ITR) Concession Company and the Ohio Turnpike and Infrastructure Commission provided either daily segment counts or entry and exit counts for a seven-or-more axle category by month for the entry and exit terminal to the toll road. Staff from both agencies were contacted and asked whether or not there was any supplemental information that could be used to estimate the proportions of the seven-axle-plus group that would be triple-trailer configurations. No such information was available. For this reason, the toll road analysis in these two States was dropped from further consideration.

In summary, two States could provide sufficient data to even attempt analysis – Idaho for the 105,500 lb. triple-trailer configurations scenario and the Kansas Turnpike for the 129,000 lb. scenario.

### ***Data Considerations***

At the same time as potential States were in the process of being examined and identified, other data needed in the analyses was also be acquired – crash data, roadway inventory and traffic volume (AADT) data, and exposure data for truck configurations based on weigh-in-motion (WIM) systems.

### **Crash Data**

The crash data required came from State crash databases, which comprise data collected by police agencies. Based on limitations in the WIM data described below, the State crash-based analyses were constrained to Interstate routes only. Since the final choice of States to be analyzed could not be made until late in the project, the USDOT study team requested and received crash data for Interstate routes from nine States (Idaho, Indiana, Kansas, Kentucky, Louisiana, Michigan, Nevada, Oregon and Utah). Data from three more States (Ohio, Maine and Washington) were received from FHWA's Highway Safety Information System (HSIS). Each

crash was linkable to data in the roadway inventory file. The data were received in various formats and were all converted to SAS files for analysis.

### Roadway Inventory and Traffic Volumes

The USDOT study team requested and received roadway inventory and AADT data for Interstate routes from the same 12 States identified above. State roadway inventory systems generally include inventory descriptors (e.g., functional class, number of lanes, median width, shoulder width, AADT, etc.) for all State routes, including all Interstate routes. Each data record describes a segment of a route which is homogeneous with respect to critical inventory variables chosen by the State (i.e., all critical variables, including AADT, remain constant throughout the entire segment). Again, data were converted from various received formats to SAS files.

For the final set of States having sufficient crash and VMT data, the study team mapped crashes to the inventory files and added counts of crashes involving the five- and six-axle vehicle and the double-trailer and triple-trailer configurations to each roadway segment as appropriate, sometimes with ramp involvement indication. Some States provided AADT information separately from road inventory information, and in some cases, the ends of the AADT segments did not align with the ends of roadway inventory segments. In these cases, the inventory segments were split where necessary to associate correct values from each file with each segment. Crashes were subsequently mapped to this re-segmented data.

### Truck Exposure Data

The WIM data estimates used were developed separately for use across all area of the study. As described in the *Volume II: Data Acquisition and Technical Analysis Plan*, WIM data were available in the data sets FHWA maintains in the Office of Highway Policy Information's Traffic Monitoring Program and LTPP databases. FHWA provided VMT data on 13 vehicle types estimated in the classification data, 12 functional highway classes, and all States, and the data were adjusted to match 2011 VMT estimates. WIM data were then used to further split the 13 vehicle types into 28 detailed vehicle classes (VCs) and 100 operating weight groups (OGWs) needed for the study. These 28 detailed vehicle classes included each of the alternative vehicle and control vehicle classes in the scenarios analyzed in this study. The weight data were not used in the safety study since weight-related categorization of crash data was not possible.

The study team originally anticipated that the WIM-based estimates of VMT for the alternative and control truck configurations could be tied to specific locations on Interstate routes in each State and then could be extrapolated to additional roadway sections based on information on alternative truck configuration flows obtained from State staffs (e.g., one assumption might be that while the VMT of the twin configuration varies with total AADT changes along an Interstate route, triple-trailer configurations VMT might be essentially constant from end to end). In addition, ideally the 2008 data used earlier in the safety plan would be similar enough to the new 2011 data to provide a second VMT data point. Unfortunately, further discussions with the FHWA Traffic Monitoring and WIM Program Managers indicated that neither assumption was true. Due to the limitations of the WIM system (e.g., collection in a single lane of a multi-lane Interstate), the data could not be subdivided further than to the functional class (rather than route location) level. In addition, the method used to estimate configuration-specific VMT in the 2008

data differed from the 2011 data to the extent that the 2008 data were not usable as a second data point.

This first restriction of WIM data to the functional class level affected the safety analyses in two ways. First, the data would not allow analysis on non-Interstate routes. The availability of one alternative or control truck VMT percentage for all roadway segments within, for example, all miles of rural principal arterials within a given State was not sufficient to develop the exposure data needed for the crash analysis. The study team anticipated that the alternative truck VMT (e.g., VMT for the Scenario 1, 2, and 3 vehicles) would vary greatly on different rural arterial roads in a given State. The differences in roadway geometrics and AADT levels among all such segments would make comparisons virtually meaningless. After careful consideration, the study team decided that the safety analyses would be restricted to urban and rural Interstate routes. This is a major limitation of the crash-based analyses.

In general, the roadway geometrics (e.g., divided roadway, curvature, grades, paved shoulder width, etc.) are more consistent across all rural or urban Interstates in a given State than would be the case for non-Interstates. In the regression analyses performed, the team used a roadway segment-based analysis method. The urban and rural Interstate route restriction means that the study assumes that the VMT for alternative (and control) trucks varies with the total AADT along any given route in these regression analyses. The team attempted to obtain information that would allow us to modify the assumption in Idaho, the State selected for the triple-trailer configurations analysis. Idaho DOT staff was contacted to obtain information on the specific triple-trailer configurations that may be operating on different Interstates or on sections of a given Interstate. Idaho DOT staff indicated that travel by triple-trailer configurations is unrestricted and that no additional information on triple-trailer configurations routing was available on a route basis.

In summary, each record in the final research files developed for each State was a homogeneous segment of Interstate highway. Crash counts for different crash types were added to each homogeneous segment. The AADT data for the segments were further divided into truck AADT categories for the alternative and control trucks using proportions from the WIM data.

### ***Analysis Methods***

This section describes the methods used to analyze the crash data that were obtained from rural and urban interstates in four States: Idaho, Michigan, Washington, and Kansas. In Kansas, only Turnpike data were included. Two approaches were used: crash involvement rates and regression models. Both are described below.

#### Crash Involvement Rates

The crash involvement rate for a truck category was defined as the ratio of the number of crash involvements to million vehicle miles traveled (MVMT). As described earlier, only axle and trailer counts were available in the crash data. The use of axle count and trailer count data does not necessarily restrict the five-axle tractor semitrailer configuration or the six-axle semitrailer configuration to the 3-S2 or 3-S3 configurations in the scenarios; there could possibly be other five-axle and six-axle semitrailer configurations in the crash data. However, examination of the



WIM data, which includes both the 3-S2 and “other five-axle semitrailer” categories indicated that, in the States analyzed, the VMT for the latter was very low compared to the VMT for the 3-S2 configuration. The 3-S2 configuration accounted for over 87 percent of the total five-axle VMT in the States analyzed. The same was true for the 3-S3 configuration and other six-axle semitrailer configurations, where the 3-S3 configuration accounted for over 99 percent of the total six-axle VMT in the States analyzed. Thus, while the five- and six-axle configurations in the crash data are very similar to the 3-S2 and 3-S3 configurations desired in the scenarios, the terms “five-axle” and “six-axle” will be used in the narrative below rather than “3-S2” and “3-S3” to more accurately portray what was used in the crash analyses.

Given this terminology, the following truck types were investigated:

- Five-axle semitrailers (including 3-S2 and other five-axle semitrailer combinations).
- Six-axle semitrailers (including 3-S3 and other six-axles semitrailer combinations)
- Five-axle and six-axle axle twin trailers
- Seven-axle and nine-axle triple trailers

The USDOT study team used data from Idaho, Michigan, Washington, and the Kansas Turnpike to calculate and compare the crash involvement rates for the five-axle semitrailers and six-axle semitrailers. Data from Idaho and the Kansas Turnpike were used to calculate the crash involvement rates for twin and triple configurations in order to compare the rates between these two configurations.

As noted above, the source of the crash data were the crash files from the State DOTs and police agencies. To determine whether a vehicle was a truck that was relevant to the study, information on vehicle configuration, number of trailers, and the number of axles were used. For Idaho, Michigan, and Washington, AADT information was obtained from the State DOT and combined with information on VMT for specific alternative and control truck configurations from the WIM files. As described earlier, the configuration-based VMT estimates for the Kansas Turnpike were developed in a different manner.

**Table 4** shows the number of crash involvements and MVMT for semitrailer truck combinations in Washington (Scenario 2) Idaho (Scenario 3) and Michigan (Scenario 3). (Rates calculated from these data are provided later in the “Results” section.) **Table 5** shows the crash involvements and MVMT for twin and triple trailers in Idaho. **Table 6** shows the crash involvements and MVMT for the Kansas Turnpike, depicting not only the twin- and triple-trailer data used in the Scenario 6 analysis, but also the five- and six-axle semitrailer data used in the later scenario analyses.

It is important to note the crash and VMT sample sizes in all three tables. The VMT and crash samples sizes for the **Table 4** six-axle alternative truck configuration in Washington are larger than those for Idaho and Michigan, but all three States provide what are considered to be adequate samples. Conversely, the sample sizes for triple-trailer combination crashes and VMT in Tables 5 (Idaho) and 6 (Kansas Turnpike) are limited. As will be noted again later, **crash involvement rates that are calculated for these categories should be used with caution.**

**Table 4: Crash Involvements and MVMT for Five- and Six-Axle Semitrailer Combinations in Washington, Idaho and Michigan**

| State      | Time Period for Crash Data | Years of Crash Data | Area Type     | Total Crash Involvements During Time Period |                    | 2011 Million Vehicle Miles (MVMT) |                    |
|------------|----------------------------|---------------------|---------------|---|--------------------|-----------------------------------|--------------------|
|            |                            |                     |               | 5-axle Semitrailer                          | 6-axle Semitrailer | 5-axle Semitrailer                | 6-axle Semitrailer |
| Scenario 2 |                            |                     |               |   |                    |                                   |                    |
| WA         | 2008-2011                  | 4                   | Rural         | 341   | 58                 | 320.66                            | 33.22              |
|            |                            |                     | Urban         | 414   | 96                 | 295.66                            | 52.07              |
|            |                            |                     | Rural & Urban | 755   | 154                | 616.32                            | 85.29              |
| Scenario 3 |                            |                     |               |   |                    |                                   |                    |
| ID         | 2008-2010                  | 3                   | Rural         | 455   | 30                 | 324.57                            | 16.01              |
|            |                            |                     | Urban         | 191   | 22                 | 95.73                             | 0.96               |
|            |                            |                     | Rural & Urban | 646   | 52                 | 420.30                            | 16.97              |
| MI         | 2008-2012                  | 5                   | Rural         | 560   | 17                 | 597.79                            | 3.76               |
|            |                            |                     | Urban         | 1352  | 75                 | 1133.80                           | 12.81              |
|            |                            |                     | Rural & Urban | 1912  | 92                 | 1731.59                           | 16.57              |

Source: Crash and travel data obtained from each State DOT. Mileage of exposure for all configurations in table calculated using CTSW WIM data provided by modal shift team.

| Table 5: Crash Involvements and MVMT for Twin and Triple-trailer configurations (Idaho)State | Time Period for Crash Data | Years of Crash Data | Area Type     | Total Crash Involvements During Time Period |                    | 2011 Million Vehicle Miles (MVMT) |                    |
|--|----------------------------|---------------------|---------------|---|--------------------|-----------------------------------|--------------------|
|  |                            |                     |               | Twins (5,6 axle)                            | Triples (7,8 axle) | Twins (5,6 axle)                  | Triples (7,8 axle) |
| ID   | 2008-2010                  | 3                   | Rural         | 37  | 13                 | 17.76                             | 10.51              |
|  |                            |                     | Urban         | 6   | 2                  | 10.13                             | 6.38               |
|  |                            |                     | Rural & Urban | 43  | 15                 | 27.89                             | 16.89              |

**Table 6: Crash Involvements and MVMT for Semitrailers, Twin, and Triple-trailer configurations (Kansas Turnpike)**

| State           | Time Period for Crash Data | Years of Crash Data | Area Type     | Total Crash Involvements During Time Period |                    |                      | Million Vehicle Miles Traveled (MVMT) 2008-2012 |                    |                      |
|-----------------|----------------------------|---------------------|---------------|---|--------------------|----------------------|---|--------------------|----------------------|
|                 |                            |                     |               | Semitrailers (5 & 6 axle)                   | Twins (5 & 6 axle) | Triples (7 & 8 axle) | Semitrailers (5 & 6 axle)                       | Twins (5 & 6 axle) | Triples (7 & 8 axle) |
| Kansas Turnpike | 2008-2012                  | 5                   | Rural         | 399   | 24                 | 8                    | 689.54  | 51.75              | 15.70                |
|                 |                            |                     | Urban         | 251   | 10                 | 2                    | 251.14  | 18.98              | 5.40                 |
|                 |                            |                     | Rural & Urban | 650   | 34                 | 10                   | 940.68  | 70.73              | 21.10                |

### Regression Models

The above-described rate analyses in effect makes two important assumptions:

- Truck crash involvements have a linear relationship to truck VMT. In other words, it is assumed that a certain increase (say, 10 percent) in MVMT would result in the same (i.e., 10 percent) increase in crash involvements.
- The truck involvement rate per truck VMT is constant over the full range of total AADTs on segments of rural and urban Interstate. In other words, increases in total AADT do not affect the truck crashes per truck VMT rate.

Contemporary safety analysis methods respond to these questionable assumptions by using regression models, which seek to develop more detailed information on the effect of total traffic volume on truck crash rates per truck mile. This approach was used for analyses in Scenarios 2 and 3, but not 5 and 6 due to the limited number of crashes associated with triple-trailer configurations in these scenarios.

The state-of-the-art method for crash modeling is to use negative binomial regression models with crash involvements as the dependent variable (depending on how the model is structured, it can be used to predict the crash involvement rate per different units of exposure; e.g., per mile or per vehicle miles traveled). The independent variables investigated included truck VMT, AADT, and segment length. AADT for each segment was obtained from the roadway inventory files for each State. Since the intent was to estimate separate models for the different truck configurations, truck volume for each configuration for each segment was needed. As noted earlier, estimates of truck VMT for each configuration were only available in the WIM data developed globally for use in each analysis area of the study. While the WIM data are collected at specific locations on rural and urban Interstates in each of the States being used, the limitations on the data collection methodology meant that the WIM-based VMT estimates were only usable at the functional class level – one estimate for rural Interstate VMT within a given State and one estimate for urban Interstate System VMT.

Given this limitation, the following are estimates for truck volume for each segment:

1. The proportion of the VMT for each truck configuration for rural and urban Interstates in each State was determined by using the VMT estimates in the WIM data. For example, the VMT proportion for five-axle semitrailers on rural Interstates in Idaho was the VMT for five-axle semitrailers on rural Interstates in Idaho divided by the total VMT on rural Interstates in Idaho. The VMT proportions calculated for the different truck configurations in Idaho, Michigan, and Washington are provided in **Table 7** below.
2. The VMT proportion for a particular truck configuration was multiplied by the AADT for a segment to estimate the truck volume for that segment. This means that the truck volume percentage (for a particular truck configuration) was assumed to be the same for all the roadway segments in a State that belonged to the same functional class. In effect, this means that the truck flow for a given configuration along a given route varies with the total AADT flow.

**Table 7: VMT Proportions from Idaho, Michigan, and Washington**

| State | Functional Class | Truck Configuration |                    |                    |                      |
|-------|------------------|---------------------|--------------------|--------------------|----------------------|
|       |                  | 5-axle Semitrailer  | 6-axle Semitrailer | Twins (5 & 6 axle) | Triples (7 & 8 axle) |
| ID    | Rural Interstate | 0.1476              | 0.0073             | 0.0081             | 0.0048               |
| ID    | Urban Interstate | 0.0745              | 0.0007             | 0.0079             | 0.0050               |
| MI    | Rural Interstate | 0.1129              | 0.0007             | N/A                | N/A                  |
| MI    | Urban Interstate | 0.0736              | 0.0008             | N/A                | N/A                  |
| WA    | Rural Interstate | 0.0701              | 0.0073             | N/A                | N/A                  |
| WA    | Urban Interstate | 0.0272              | 0.0048             | N/A                | N/A                  |

*N/A = Not applicable*

The following model forms were investigated:

$$Y = TruckVMT \times e^a \times \left( \frac{AADT}{10000} \right)^b \quad (1)$$

$$Y = Length \times e^a \times \left( \frac{AADT}{10000} \right)^b \times (truckvolume)^c \quad (2)$$

$$Y = Length \times e^a \times \left( \frac{AADT}{10000} \times truckvolume \right)^b \quad (3)$$

Where:

- Y = yearly number of crash involvements for a particular truck configuration in a segment.
- TruckVMT = million vehicle miles traveled for each truck configuration in each segment,
- Length = the length of the segment in miles,
- AADT = the annual average daily traffic, and
- a, b, c = parameters to be estimated as part of a negative binomial regression.

In model form 1, TruckVMT was included as an offset (i.e., the coefficient multiplying TruckVMT is set to 1.0). In model forms 2 and 3, roadway section length was included as an offset. By including offsets, it is possible to investigate rates – model form 1 would predict the rate of truck crash involvements per VMT as a function of AADT. Model forms 2 and 3 would predict the rate of truck crash involvements per mile as a function of two different types of “combined exposure,” including both truck volume and total AADT.

Model forms 1 and 2 could not be reliably estimated due to the co-linearity between AADT and truck volume. So, only model form 3 was used. In model form 3, the combined exposure term is the product of total traffic volume and truck volume (the 10,000 used in the denominator for AADT is a scaling factor that is used to obtain more significant digits in the estimation process when one of the independent variables is large compared to other independent variables). If *b* is 1.0, then the relationship between crash involvements per mile and the exposure (product of AADT and truck volume) is linear. If linear, then greater confidence can be placed on the use of the truck involvements per VMT rate described in the previous section. Many previous studies have shown that the relationship between crashes and exposure is typically non-linear. So, in most cases, *b* is expected to be different from 1.0.

Parameter *b* can be used to determine the rate of increase in crashes as a function of exposure. If *b* is higher, then crashes increase faster with exposure compared to when *b* is lower. If there are differences in the size of the *b* parameters for a given alternative truck configuration versus the control vehicle scenario (e.g., five-axle semitrailer vs. six-axle semitrailer), then the rate per mile for one configuration is more sensitive to total AADT and truck volume than the rate per mile for the other configuration.



## **Results**

Because of the small crash sample sizes available for some of the following analyses, particularly for the triple trailer configurations, results are reported where the p-value resulting from the statistical test conducted (i.e.,  $p \leq 0.15$ ) is higher than what is typically reported (i.e.,  $p \leq 0.05$ ). The use of this broader range of significance levels has been supported by others (e.g., Hauer, 2004). In the findings below, the term “significant” will be used to refer to findings at the  $p \leq 0.05$  level, and the term “marginally significant” will be used for findings with p-values between 0.05 and 0.15.

### Crash Involvement Rates

**Tables 8, 9, and 10** show the crash involvement rates along with the average crash involvements per year in each State for the different vehicle configurations. It is clear from **Table 8** that the crash involvement rates for six-axle alternative truck configurations are consistently higher compared to the five-axle control configuration. **The rate for urban six-axle semitrailers in Idaho is unusually high (7.634)** and, as shown in **Table 4**, based on very low estimated VMT relative to the other cells. **It should be viewed with extreme caution.** Based on the data in **Table 4** showing that the VMT of six-axle semitrailers in Idaho and Michigan is much lower (about 17 million vehicle miles) compared to that in Washington (85 million vehicle miles), the Washington rates are likely more reliable estimates; however, note that they are for a configuration with different GVW limits.

A likelihood ratio test (Al-Ghamdi, 2007) was conducted to test the statistical difference between the crash involvement rates of five-axle semitrailers and six-axle semitrailers. The results revealed that the difference was statistically significant (at the 0.05 significance level) in all cases except for rural interstates in Idaho.

Based on **Table 9** (from Idaho), the crash involvement rates for triple-trailer configurations are lower compared to twin-trailer configurations. As discussed earlier, triple-trailer configurations have very limited VMTs and, consequently, a limited number of crashes ( $n=15$ ). The likelihood ratio test revealed that while the differences between the crash involvement rates of twin-trailer and triple-trailer configurations were not statistically significant at the 0.05 significance level, the differences in rates on rural Interstates and combined urban and rural Interstates were marginally significant (i.e.,  $p < 0.10$ ). Limitations in VMTs (and consequently crashes [ $n=15$ ]) preclude any further explanation.

The results from **Table 10** (from Kansas Turnpike) are slightly different from those in Idaho for twin-trailer and triple-trailer configurations. The overall rate (for combined rural and urban roads) for twin-trailer and triple-trailer configurations is almost identical. On rural roads, the rate for triple-trailer configurations is slightly higher, and in urban roads, the rate for triple-trailer configurations is lower. The likelihood ratio test revealed that the differences between the rates of twin-trailer and triple-trailer configurations were not statistically significant at the  $p=0.15$  significance level. Note again that there was a small sample of triple-trailer configuration crashes in this analysis ( $n=10$ ). (Note that the rates presented for semitrailer configurations will be used in the later scenario analyses.)

**Table 8: Crash Involvement Rates for Five-Axle and Six-Axle Semitrailers (Scenarios 2 and 3)**

| State      | Area type     | Average crash involvements per year |                    | Crash Involvement rate per MVM per year |                    | p-value for difference in rates |
|------------|---------------|-------------------------------------|--------------------|---|--------------------|---------------------------------|
|            |               | 5-axle semitrailer                  | 6-axle semitrailer | 5-axle semitrailer                      | 6-axle semitrailer |                                 |
| Scenario 2 |               |                                     |                    |   |                    |                                 |
| WA         | Rural         | 85.25                               | 14.50              | 0.266                                   | 0.437              | $p \leq 0.05$                   |
|            | Urban         | 103.50                              | 24.00              | 0.350                                   | 0.461              | $p \leq 0.05$                   |
|            | Rural & Urban | 188.75                              | 38.50              | 0.306                                   | 0.451              | $p \leq 0.05$                   |
| Scenario 3 |               |                                     |                    |   |                    |                                 |
| ID         | Rural         | 151.67                              | 10.00              | 0.467                                   | 0.625              | NS                              |
|            | Urban         | 63.67                               | 7.33               | 0.665                                   | 7.634              | NT                              |
|            | Rural & Urban | 215.33                              | 17.33              | 0.512                                   | 1.021              | $p \leq 0.05$                   |
| MI         | Rural         | 112.00                              | 3.40               | 0.187                                   | 0.903              | $p \leq 0.05$                   |
|            | Urban         | 270.40                              | 15.00              | 0.238                                   | 1.171              | $p \leq 0.05$                   |
|            | Rural & Urban | 382.40                              | 18.40              | 0.221                                   | 1.111              | $p \leq 0.05$                   |

NS: Not significant. Difference in rates was not statistically significant at the  $p \leq 0.15$  level.

NT: Not tested due to low sample size of urban crashes in Idaho (see Table 5 showing only six twin-trailer and two triple-trailer crashes on urban Interstates in Idaho)

**Table 9: Crash Involvement Rates for Twin Trailer and Triple-trailer configurations in Idaho (Scenario 5).**

| Area type     | Average crash involvements per year |                      | Crash Involvement rate per MVM per year |                      | p-value for difference in rates |
|---------------|-------------------------------------|----------------------|---|----------------------|---------------------------------|
|               | Twins (5 & 6 axle)                  | Triples (7 & 8 axle) | Twins (5 & 6 axle)                      | Triples (7 & 8 axle) |                                 |
| Rural         | 12.33                               | 4.33                 | 0.694                                   | 0.412                | $p < 0.10$                      |
| Urban         | 2.00                                | 0.67                 | 0.197                                   | 0.105                | NS*                             |
| Rural & Urban | 14.33                               | 5.00                 | 0.514                                   | 0.296                | $p < 0.10$                      |

NS: Not significant. Difference in rates was not statistically significant at the  $p \leq 0.15$  level.



**Table 10: Crash Involvement Rates for Semitrailers, Twin Trailer, and Triple-trailer configurations for the Kansas Turnpike (Scenario 6)**

| Area type     | Average crash involvements per year |                    |                      | Crash Involvement rate per MVM |                    |                      | p-value for difference in Twins and Triples rates |
|---------------|-------------------------------------|--------------------|----------------------|--------------------------------|--------------------|----------------------|---|
|               | Semitrailer (5 & 6 axle)            | Twins (5 & 6 axle) | Triples (7 & 8 axle) | Semitrailer (5 & 6 axle)       | Twins (5 & 6 axle) | Triples (7 & 8 axle) |   |
| Rural         | 79.80                               | 4.80               | 1.60                 | 0.579                          | 0.464              | 0.509                | NS  |
| Urban         | 50.20                               | 2.00               | 0.40                 | 0.999                          | 0.527              | 0.370                | NS  |
| Rural & Urban | 130.00                              | 6.80               | 2.00                 | 0.691                          | 0.481              | 0.474                | NS  |

NS: Not significant. Difference in rates was not statistically significant at the  $p \leq 0.15$  level.

Regression Models

Recall that the modeling effort involved development of a regression model of the following form:

$$Y = Length \times e^a \times \left( \frac{AADT}{10000} \times truckvolume \right)^b \quad (3)$$

Where:

- Y = yearly number of crash involvements for a particular truck configuration in a segment.
- TruckVMT = million vehicle miles traveled for each truck configuration in each segment,
- Length = the length of the segment in miles,
- AADT = the annual average daily traffic, and
- a, b, c = parameters to be estimated as part of a negative binomial regression.

**Table 11** shows the model parameter estimates for model form 3 for both the five-axle control truck configuration and the six-axle alternative truck configuration. In all the models, rural and urban roads were combined since the sample was not adequate to estimate separate models.

Along with the estimates and the standard errors for a and b, several goodness of fit statistics are provided.  $k_1$  is the over-dispersion parameter. Based on the recommendation from Hauer (2001), this was estimated for unit length of the road (i.e., for 1 mile)<sup>2</sup>. Unlike traditional linear regression there is no unique  $R^2$  in negative binomial models. Two commonly used  $R^2$  are presented: Freeman Tukey  $R^2$  (Fridstrom et al., 1995) and the Pseudo  $R^2$  (Miaou, 1996). The Pseudo  $R^2$  is estimated on the basis of the over-dispersion parameter of the model with the independent variables compared to the over-dispersion parameter of a model with just the intercept term (i.e., just a). The Freeman Tukey  $R^2$  tends to be low when the data are sparse, which is the case with truck crashes. So, some researchers prefer to use the Pseudo  $R^2$  in these circumstances.

<sup>2</sup> When the over-dispersion parameter is estimated per unit length, the relationship between the variance (V) and the expected value (E) is as follows:  $V = E + E^2k/L$ , where L is the length of a segment.

**Table 11: Negative Binomial Models (Five-Axle and Six-Axle Semitrailers)**

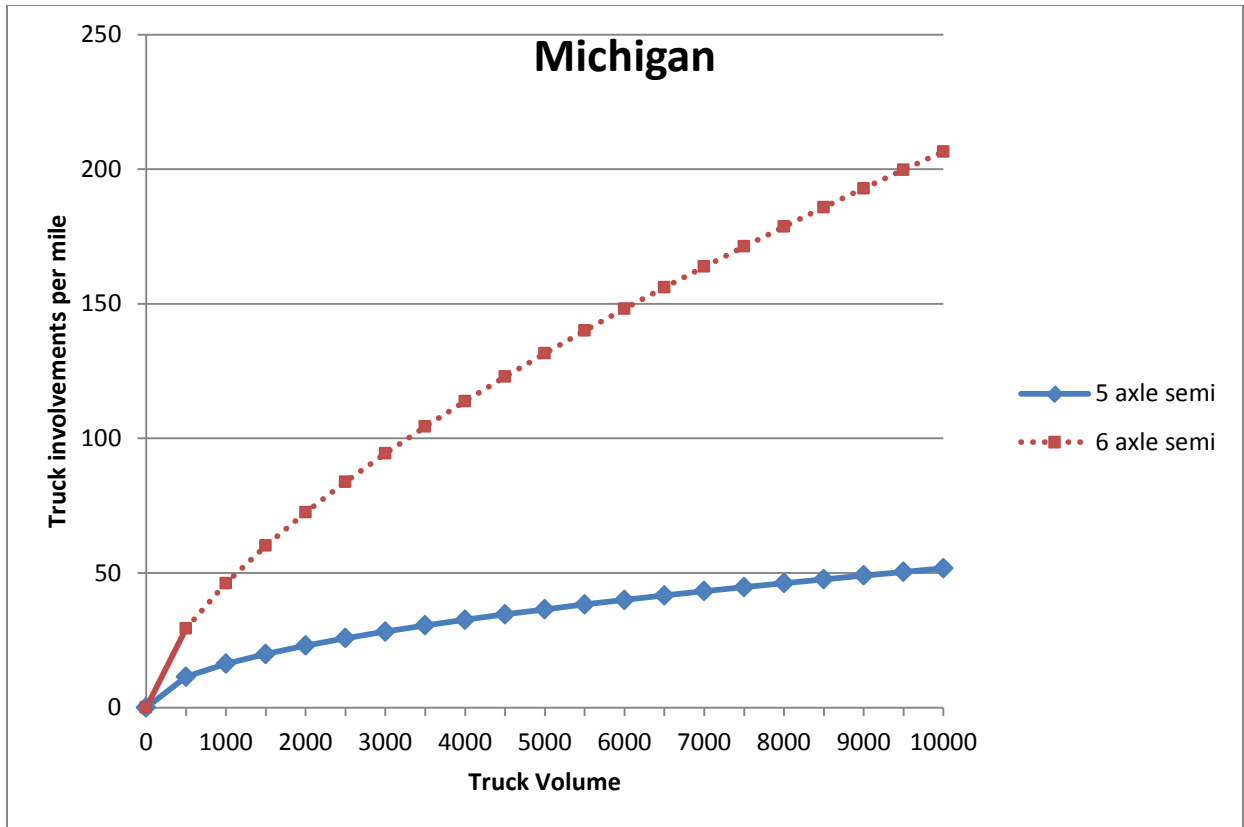
| State | Truck Type         | Estimate (standard error)             |                    | Goodness of fit statistics |                       |                     |              | Crash involvements |
|-------|--------------------|---------------------------------------|--------------------|----------------------------|-----------------------|---------------------|--------------|--------------------|
|       |                    | a                                     | b                  | $k_1$                      | Pearson chi-square/df | Freeman-Tukey $R^2$ | Pseudo $R^2$ |                    |
| ID    | 5-axle semitrailer | -3.2221<br>(0.3277)                   | 0.2799<br>(0.0415) | 3.0052                     | 1.13                  | 0.195               | 0.235        | 646                |
|       | 6-axle semitrailer | Reliable model could not be estimated |                    |                            |                       |                     |              | 52                 |
| MI    | 5-axle semitrailer | -6.0790<br>(0.2137)                   | 0.5026<br>(0.0213) | 1.3175                     | 1.49                  | 0.056               | 0.490        | 1912               |
|       | 6-axle semitrailer | -7.6408<br>(0.4789)                   | 0.6503<br>(0.0785) | 2.8341                     | 1.01                  | 0.018               | 0.675        | 92                 |
| WA    | 5-axle semitrailer | -4.6259<br>(0.2563)                   | 0.3520<br>(0.0267) | 0.4252                     | 1.42                  | 0.020               | 0.306        | 731                |
|       | 6-axle semitrailer | -5.9608<br>(0.4120)                   | 0.4107<br>(0.0516) | 0.3560                     | 1.26                  | 0.003               | 0.418        | 49                 |

As shown in **Table 11**, reliable models could not be estimated for six-axle alternative configurations in Idaho. The goodness of fit statistics indicate the remaining models to be reasonable. For the other two States, it is clear that  $b$  is very different from 1.0, indicating that the relationship between crash involvements and exposure (i.e., product of AADT and truck volume) is not linear. This indeed raises some caution about the use of rates in comparisons of alternative truck and control truck configurations. If possible (i.e., if adequate roadway segment-based exposure data become available), future analyses of truck safety should use regression-type approaches to overcome this issue.

In addition, in Michigan,  $b$  is higher for the six-axle semitrailers compared to the five-axle semitrailers, suggesting that crash involvements among vehicles with the six-axle alternative configuration increase at a much faster rate with an increase in exposure compared to five-axle control configuration. In Washington, there is very little difference between the  $b$  for the six-axle model and that for the five-axle model. These contrasting findings are explored more in the following section.

### Plots

Using the models that were estimated for Michigan and Washington, the plots shown in **Figures 2 and 3** were created between truck involvements per mile on the y-axis and truck volume on the x-axis. The main purpose of the plots was to show the shape of the relationship between crash involvements and truck volume. Since the truck involvement rate per mile shown in these plots is a function of both truck volume and AADT, the plots were created for the mean value of AADT in the two States. In Michigan, the mean AADT was 46,000, and in Washington, the mean AADT was 55,000. These average AADTs are weighted averages based on segment lengths.

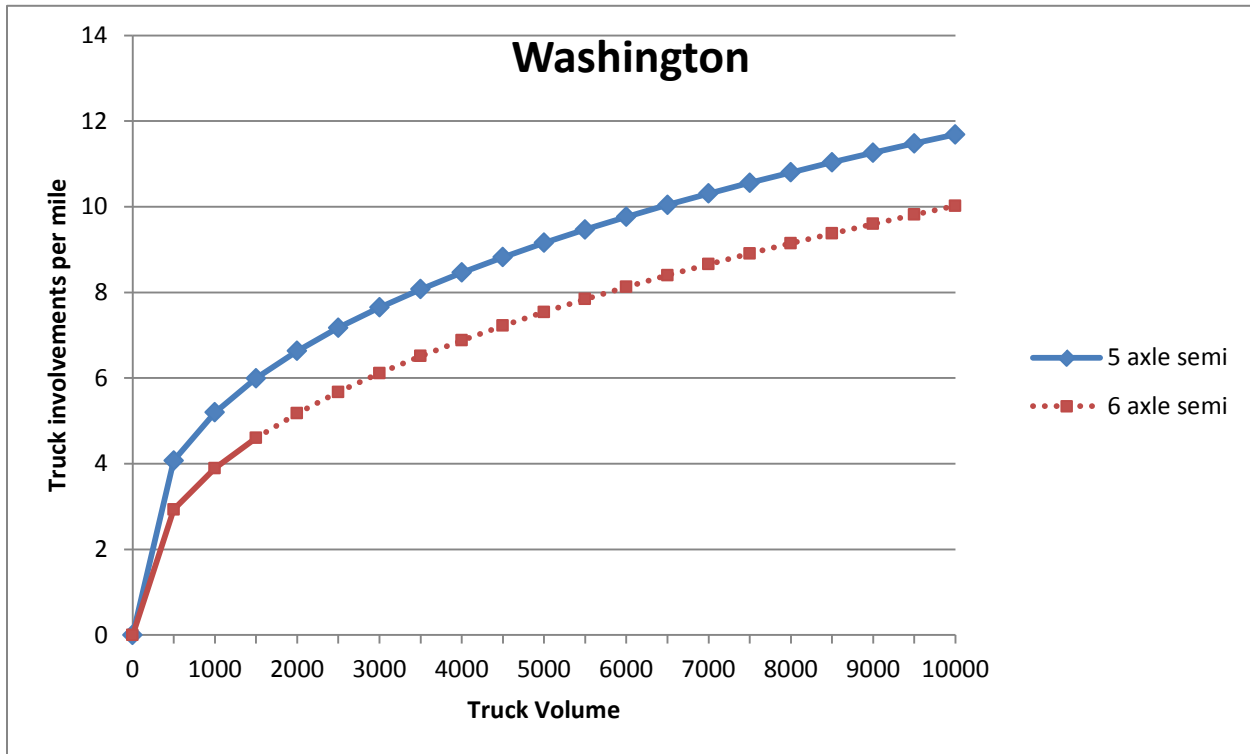


**Figure 2: Truck Involvements per Mile versus Truck Volume for Six-Axle Alternative Truck Configurations and Five-Axle Configurations in Michigan**

In Michigan, the maximum daily volume for five-axle semitrailer combinations was 15,500, and the maximum daily volume for six-axle semitrailers was 170. In Washington, the maximum daily volume for five-axle semitrailers was 8,500, and the maximum daily volume for six-axle semitrailers was 1,150.

The plot was created from truck volume 0 through 10,000. For six-axle semitrailers, only a portion of the line is shown as a solid line (the rest is a dashed line) representing the fact that the maximum volumes for this vehicle configuration were very low compared to the volumes for the five-axle semitrailers. It is clear from these plots that the relationship between truck involvement rate per mile and truck volume is not a straight line, again showing the limitation of using truck involvement per VMT rate in the comparison of scenario and control truck configurations.

The plots also demonstrate the differences between the WA and Michigan models for the six-axle alternative truck configurations vs. the five-axle control truck configurations, with the Michigan data suggesting that crash involvements among six-axle alternative truck configurations increase at a much faster rate with increases in exposure compared to that for the five-axle control configuration. Given the fact that the Washington data (which show very little difference in *b* values for the two configurations) is based on much higher truck VMTs, whether or not involvement rates per VMT for six-axle configurations do indeed increase more than rates for the five-axle control configuration remains an issue for further study.



**Figure 3: Truck Involvements per Mile versus Truck Volume for Six-Axle Alternative Truck Configurations and Five-Axle Controls in Washington.**

In addition to the crash rate and modeling analyses described above, the safety team conducted two additional analyses to determine (1) the severity of crashes involving each scenario configuration and control truck configuration, and (2) longitudinal barrier impacts involving the different scenario and control configurations. Both of these analyses used the same truck involvements used in the above-described rate and modeling analyses.

Crash Severity

The USDOT study team developed a measure of injury for use in analyzing crash severity that included not only injuries to truck occupants, but also injuries to occupants of non-trucks involved in a truck-related crash. All but one of the crash databases used in the above analyses included a “crash severity” variable, which captured the most severe injury in any vehicle involved in the crash. While this information was not included in the Idaho crash file, it was derived based on included variables related to the number of injuries in the crash for each injury level (e.g., total number of fatalities in the crash).

The “KABCO” scale is used by each State as a measure of the functional injury level of the victim at a crash scene. The codes are selected based on the on-site judgment of the investigating police officer completing the crash report. While there may be minor differences in the descriptions for each severity level across the States, in general, the following definitions apply:

- K – Fatal injury
- A – Incapacitating (serious) injury
- B – Non-incapacitating (Moderate) injury
- C – Possible (Minor) injury
- O – No injury (property damage only).

In the tables below, the A, B and C categories are combined into one “Injury” category.

Also note that injury frequencies shown in each of the tables below are the number of truck involvements in crashes rather than the number of truck-related crashes. The maximum injury severity in the crash is linked to each truck involvement. If two trucks are in the same crash (e.g., a twin vs. a triple), the same maximum injury severity in the crash is assigned to both. The use of truck involvements makes these tables consistent with the earlier analyses, which were also based on involvements, and should not differ much from crash-based frequencies since crashes involving more than one truck are rare. Finally, since the States did not provide person/occupant files, it is not possible to analyze injury to truck occupants separately from injury to non-truck occupants using the State data.

In terms of interpreting the importance of differences in the tables, note that the distributions for each pair of alternative and control trucks were compared using the Fisher’s exact test for contingency tables (Fisher, 1922). It is most useful when sample sizes are small, but it is valid for all sample sizes. It was first developed for a 2 X 2 table, a table constructed of two x-axis values and two y-axis values, but has since been extended to the general case of an m X n table (Mehta and Patel, 1983). In this study, the Fisher’s exact test was implemented using the SAS statistical software.

**Table 12** shows the severity results for the control and alternative truck configurations in Scenario 2 – a comparison of the five-axle control configuration with the six-axle alternative configuration. All results in this scenario use data from Washington. While the non-injury percentages for the six-axle alternative configurations are slightly higher in all three comparisons, none of the differences are even marginally significant at the  $p=0.15$  level.

**Tables 13 and 14** show the severity results for the alternative and control truck configurations from Scenario 3 – comparison of the five-axle control semitrailer with the heavier six-axle alternative vehicle. **Table 13** results are from Idaho data and **Table 14** results are from Michigan data. As noted earlier, while the scenario targets were a six-axle, 97,000-lb. configuration and a five-axle, 80,000-lb. control configuration, both Idaho and Michigan allow the six-axle configuration to operate up to 105,500 lbs. and the five-axle control vehicle to operate up to 86,000 lbs.

In Idaho, the involvements of the Scenario 3 six-axle configurations appear to be less severe than the five-axle control vehicle involvements. The rural and urban Interstate differences are marginally significant ( $p=0.07$  and  $p=0.14$ , respectively), and the combined distribution differences are significant at the  $p=0.01$  level. The Michigan rural Interstate distributions follow the same pattern as the Idaho distribution (i.e., less severe involvements for the six-axle alternative configuration,  $p=0.14$ ), but there are no differences in the distributions for the urban or combined situations.

**Table 12: Severity of Crashes Involving the Five-Axle Single Control and Six-Axle Scenario 2 Configurations on Interstates in Washington**

| Rural/<br>Urban  | Severity   | Truck Configuration |         |                    |         |
|------------------|------------|---------------------|---------|--------------------|---------|
|                  |            | 5-Axle Semitrailer  |         | 6-Axle Semitrailer |         |
|                  |            | Frequency           | Percent | Frequency          | Percent |
| Rural            | Fatal      | 3                   | 0.90    | 0                  | 0.00    |
|                  | Injury     | 118                 | 34.81   | 17                 | 29.31   |
|                  | Non-Injury | 218                 | 64.30   | 41                 | 70.70   |
|                  | Total      | 339                 | 100.00  | 58                 | 100.00  |
| Urban            | Fatal      | 7                   | 1.70    | 0                  | 0.00    |
|                  | Injury     | 170                 | 41.06   | 37                 | 38.54   |
|                  | Non-Injury | 237                 | 57.20   | 59                 | 61.50   |
|                  | Total      | 414                 | 100.00  | 96                 | 100.00  |
| Rural &<br>Urban | Fatal      | 10                  | 1.30    | 0                  | 0.00    |
|                  | Injury     | 288                 | 38.25   | 54                 | 35.06   |
|                  | Non-Injury | 455                 | 60.40   | 100                | 64.90   |
|                  | Total      | 753                 | 100.00  | 154                | 100.00  |

**Table 13: Severity of Crashes Involving the Five-Axle Single Control and the Six-Axle Scenario 3 Configurations on Interstates in Idaho**

| Rural/<br>Urban  | Severity   | Truck Configuration |         |                    |         |
|------------------|------------|---------------------|---------|--------------------|---------|
|                  |            | 5-Axle Semitrailer  |         | 6-Axle Semitrailer |         |
|                  |            | Frequency           | Percent | Frequency          | Percent |
| Rural            | Fatal      | 5                   | 1.10    | 0                  | 0.00    |
|                  | Injury     | 130                 | 28.57   | 3                  | 10.00   |
|                  | Non-Injury | 320                 | 70.30   | 27                 | 90.00   |
|                  | Total      | 455                 | 100.00  | 30                 | 100.00  |
| Urban            | Fatal      | 6                   | 3.10    | 0                  | 0.00    |
|                  | Injury     | 51                  | 26.70   | 2                  | 9.09    |
|                  | Non-Injury | 134                 | 70.20   | 20                 | 90.90   |
|                  | Total      | 191                 | 100.00  | 22                 | 100.00  |
| Rural &<br>Urban | Fatal      | 11                  | 1.70    | 0                  | 0.00    |
|                  | Injury     | 181                 | 28.02   | 5                  | 9.62    |
|                  | Non-Injury | 454                 | 70.30   | 47                 | 90.40   |
|                  | Total      | 646                 | 100.00  | 52                 | 100.00  |

**Table 14: Severity of Crashes Involving the Five-Axle Single Control and the Six-Axle Scenario 3 Configurations on Interstates in Michigan**

| Rural/<br>Urban  | Severity   | Truck Configuration |         |                    |         |
|------------------|------------|---------------------|---------|--------------------|---------|
|                  |            | 5-Axle Semitrailer  |         | 6-Axle Semitrailer |         |
|                  |            | Frequency           | Percent | Frequency          | Percent |
| Rural            | Fatal      | 11                  | 2.00    | 1                  | 5.90    |
|                  | Injury     | 112                 | 20.00   | 1                  | 5.88    |
|                  | Non-Injury | 437                 | 78.00   | 15                 | 88.20   |
|                  | Total      | 560                 | 100.00  | 17                 | 100.00  |
| Urban            | Fatal      | 17                  | 1.30    | 1                  | 1.30    |
|                  | Injury     | 358                 | 26.48   | 19                 | 25.33   |
|                  | Non-Injury | 977                 | 72.30   | 55                 | 73.30   |
|                  | Total      | 1352                | 100.00  | 75                 | 100.00  |
| Rural &<br>Urban | Fatal      | 28                  | 1.50    | 2                  | 2.20    |
|                  | Injury     | 470                 | 24.58   | 20                 | 21.74   |
|                  | Non-Injury | 1414                | 74.00   | 70                 | 76.10   |
|                  | Total      | 1912                | 100.00  | 92                 | 100.00  |

**Table 15** shows the severity results for the control and alternative truck configurations from Scenario 5. These results are from Idaho, and the maximum GVWs for both the control and scenario vehicle match the desired GVWs.

The sample sizes for the triple-trailer configurations are very small, making comparisons difficult. Almost all the triple-trailer configurations crashes are on rural Interstates. Comparison of the non-injury crashes shows the triple-trailer configuration to have a higher percentage. The difference in the rural Interstate distributions is marginally significant ( $p=.09$ ).

**Table 15: Severity of Crashes Involving the Five-Axle Double Control and the Seven-Axle Scenario 5 Configurations on Interstates in Idaho**

| Rural/<br>Urban  | Severity   | Truck Configuration |         |                 |         |
|------------------|------------|---------------------|---------|-----------------|---------|
|                  |            | Twin Trailers       |         | Triple Trailers |         |
|                  |            | Frequency           | Percent | Frequency       | Percent |
| Rural            | Fatal      | 0                   | 0.00    | 1               | 7.70    |
|                  | Injury     | 6                   | 16.22   | 4               | 30.77   |
|                  | Non-Injury | 31                  | 83.80   | 8               | 61.50   |
|                  | Total      | 37                  | 100.00  | 13              | 100.00  |
| Urban            | Fatal      | 0                   | 0.00    | 0               | 0.00    |
|                  | Injury     | 1                   | 16.67   | 0               | 0.00    |
|                  | Non-Injury | 5                   | 83.30   | 2               | 100.00  |
|                  | Total      | 6                   | 100.00  | 2               | 100.00  |
| Rural &<br>Urban | Fatal      | 0                   | 0.00    | 1               | 6.70    |
|                  | Injury     | 7                   | 16.28   | 4               | 26.67   |
|                  | Non-Injury | 36                  | 83.70   | 10              | 66.70   |
|                  | Total      | 43                  | 100.00  | 15              | 100.00  |

**Table 16** shows the severity results for the control and alternative truck configurations from Scenario 6. These results are from the Kansas Turnpike data, where the maximum GVW for triple-trailer configurations on the Turnpike is 120,000 lb. rather than the desired 129,000 lb. A realistic maximum GVW for twin-trailer configurations could not be determined. Note that the number of crashes involving triple-trailer configurations is so small that the rural and urban counts are combined in **Table 16**.

**Table 16: Severity of Crashes Involving the Five-Axle Double Control and the Nine-Axle Scenario 6 Configurations on Interstates the Kansas Turnpike**

| Rural/Urban      | Severity   | Truck Configuration |         |                 |         |
|------------------|------------|---------------------|---------|-----------------|---------|
|                  |            | Twin Trailers       |         | Triple Trailers |         |
|                  |            | Frequency           | Percent | Frequency       | Percent |
| Rural &<br>Urban | Fatal      | 0                   | 0.00    | 0               | 0.00    |
|                  | Injury     | 11                  | 32.35   | 2               | 20.00   |
|                  | Non-Injury | 23                  | 67.60   | 8               | 80.00   |
|                  | Total      | 34                  | 100.00  | 10              | 100.00  |

Because of the small sample sizes for both the alternative and control vehicles, no differences in distribution can be seen or were found with the statistical testing.

In summary, the analysis of crash severity distributions for the alternative truck and control truck configurations in the different scenarios yield slightly different results. The comparisons of twins and triple-trailer configurations were consistently unable to find any differences; small sample sizes likely contributed to this result. Comparisons for Scenarios 2 and 3 showed some indication of reduced crash severity for the six-axle alternative truck configurations compared to the five-



axle control vehicle, although this finding was more apparent in Idaho and less apparent in Michigan.

### Crashes Involving Longitudinal Barriers

The USDOT study team also investigated possible differences in the behavior of longitudinal barriers when struck by the different control and scenario vehicle configurations. Longitudinal barriers for use in Federally funded projects are currently evaluated based on a series of crash tests where the maximum GVW is 80,000 lb. for a tractor semitrailer combination. On question is whether the heavier trucks in the scenarios would penetrate the existing roadside barriers more often, either resulting in greater injury to the truck driver or to occupants of other vehicles struck if the truck penetrates a median barrier or is redirected into other vehicles as the result of a shoulder barrier impact.

The study team examined this issue by using computerized data in the crash and vehicle/unit files, which would (1) identify run-off-road crashes into barriers and (2) give some indication of a subsequent hazardous impact into either a vehicle or another (possibly hazardous) object. While no State database includes a variable indicating whether a barrier has been penetrated or not, the presence of a subsequent impact with either another vehicle or with a possibly hazardous object would provide at least some information on possible penetration or poor redirection. The nature and percentages of “poor performance after barrier impact” can be compared in impacts involving a control truck vs. an alternative truck.

In effect, this requires that a State’s crash data to include the following:

- A sequence-of-events (SOE) variable for each vehicle in the crash with at least three events coded;
- That the SOE include “run-off-road” as a possible first event;
- That the SOE include codes for impacts with specific longitudinal barriers (e.g., guardrail face or end, median barrier, concrete barrier, cable barrier, etc.) rather than grouping all longitudinal barriers with other “fixed objects”; and
- That the SOE also include codes for “other motor vehicle” and other potentially hazardous objects that could be struck after barrier impact (e.g., ditch, embankment, tree, overhead sign support, bridge pier, culvert, etc.).

The variables in the crash and vehicle files were examined for each of the four States used in the other crash analyses – Idaho, Kansas, Michigan and Washington. Idaho and Michigan files both met the above requirements. While both Kansas and Washington had an SOE variable, longitudinal barriers were grouped with all other fixed objects, thus they were not used in this analysis. To be consistent, the trucks examined in this analysis were the same as in the other analyses. All impacts occurred on rural or urban Interstates in Idaho and Michigan. The crashes on urban and rural Interstates were combined to increase the sample size and because the design of longitudinal barriers would be the same in both types of location.

With respect to Scenarios 2 and 3, both Idaho and Michigan data were used in the comparisons with the 80,000-lb. control vehicle. The first step in the procedure was to scan the SOE codes to identify vehicles that had run off the road. A manual review of the SOEs indicated that different

sequences were being used to describe ran-off-road (ROR) crashes both within and between States. Based on this review, the following codes or combinations were used to identify ROR crashes:

- A ran-off-road code in Event 1
- A code for any impact with a fixed object normally found on the roadside in Event 1 (e.g., guardrail, bridge pier/abutment, ditch)
- Event 1 was “loss of control” and Event 2 was either “run off the road” or an impact with a roadside fixed object

Second, each ROR event was screened to identify a next event involving a guardrail face or guardrail end in both States, a concrete traffic barrier in Idaho or a median barrier in Michigan. (No impacts with bridge rails were found as the next event in either State.) Finally, for this barrier-related subset, the subsequent event or events were scanned to determine how many involved subsequent impacts that would likely be hazardous to either the truck or to another roadway user. Of the 65 different event codes in Idaho, 33 were selected as having “likely hazardous” impacts. These included the following codes:

- Immersion
- Pedestrian
- Pedal cycle
- Train
- Other Object Not Fixed
- Parked Car
- Impact Attenuator
- Bridge Pier/Abutment
- Bridge Parapet End
- Overpass
- Overhead Sign
- Luminaire/Light Support
- Utility Pole
- Other Post, Pole or Support
- Culvert
- Ditch
- Embankment
- Tree
- Building/Wall
- Other Fixed Object
- Impact with Another Vehicle (10 Crash types codes)
- Came Back On Road
- Traffic Signal Support
- Utility/Light Support

A very similar list of “likely hazardous” impacts was identified in Michigan’s list of 45 event codes. Note that while “Overturn” is not included in the list above, counts were made of truck overturns immediately after barrier impact. While perhaps not a measure of possible barrier penetration, it is a measure of potential harm after barrier impact.

Example SOE codes not chosen to identify hazardous subsequent impacts included those related to fire/explosion, animals, other longitudinal barriers, delineator posts, traffic sign posts, curbs, mailboxes, etc. **Table 17** shows the results of this analysis for 3-S2s and 3-S3s in both Idaho and Michigan.

**Table 17: Results of Sequence-of-Events Analyses for Idaho and Michigan  
(Five-Axle and Six-Axle Truck Configurations)**

|   | 5-Axle<br>Semitrailer | 6-Axle<br>Semitrailer |
|---|-----------------------|-----------------------|
| <b>Idaho</b>                                      |                       |                       |
| No. of Total truck involvements                   | 648                   | 52                    |
| No. of ROR involvements                           | 143                   | 11                    |
| ROR as a percent of total involvements            | 22.1%                 | 21.2%                 |
| No. of Barrier involvements                       | 28                    | 3                     |
| Barrier involvement percent of ROR involvements   | 19.6%                 | 27.3%                 |
| No. of Subsequent Hazardous Events                | 10                    | 1                     |
| Subsequent event percent of barrier involvements  | 35.7%                 | 33.3%                 |
| No. of Overturns immediately after barrier impact | 5                     | 1                     |
| Immediate overturn percent of barrier impacts     | 17.9%                 | 33.3%                 |
| <b>Michigan</b>                                   |                       |                       |
| No. of Total truck involvements                   | 1912                  | 92                    |
| No. of ROR involvements                           | 166                   | 14                    |
| ROR as a percent of total involvements            | 8.7%                  | 15.2%                 |
| No. of Barrier involvements                       | 46                    | 1                     |
| Barrier involvement percent of ROR involvements   | 27.7%                 | 7.1%                  |
| No. of Subsequent Hazardous Events                | 4                     | 0                     |
| Subsequent event percent of barrier involvements  | 8.7%                  | 0.0%                  |
| No. of Overturns immediately after barrier impact | 2                     | 0                     |
| Immediate overturn percent of barrier impacts     | 4.4%                  | 0.0%                  |

The primary data of interest here are the percent of barrier involvements followed by subsequent hazardous event. However, the small sample of alternative truck configurations involved in longitudinal barrier impacts in each State (i.e., three in Idaho and one in Michigan) makes drawing conclusions concerning behavior after impact impossible.

The study team also attempted to conduct similar analyses for comparisons of the control double with the Scenario 5 configuration in Idaho, where of the 43 control double configuration involvements, 12 (27.9 percent) were in ROR crashes. However, only one (8.3 percent) of the ROR impacts involved a longitudinal barrier, and an overturn occurred after that barrier impact. Of the 15 Scenario 5 configuration involvements, 6 (40 percent) were in ROR crashes, but none involved longitudinal barriers. Obviously, no conclusions can be drawn from these data.

In summary, while an attempt was made to quantitatively analyze differences in behavior after longitudinal barrier impact for alternative vs. control truck configurations, the analysis of available data indicated that such a comparison was impossible. The sample sizes of the control vehicles and the scenario vehicles striking roadside barriers were not sufficient for conclusions to be drawn. One logical interpretation of this finding is that ROR events do occur with the control and alternative configurations, but barrier involvements are relatively rare, and events subsequent to impacting a barrier are rarer still.

A logical sequence for additional research concerning possible barrier issues would be to expand the State crash databases studied with the above methodology by not limiting them to States which closely match the specific scenarios studied here. As noted earlier, there are additional States that currently allow heavier single semitrailer and double- and triple-trailer configurations. While not known, it would be expected that some of these States would have the needed SOE and hazardous impact codes. Such an analysis would provide needed information on the size of the problem (if any), which would help determine whether additional analysis based on barrier impact simulation or barrier crash testing are justified.

Currently, FHWA has a finite element analysis (FEA) model for an 80,000-lb. tractor-semitrailer (van) configuration. Additional FEA models could be developed for the six scenario configurations showing the largest problems in the crash data. Simulations with these new FEA models would then provide guidance for possible additional barrier crash testing involving the configurations shown to be problematic. Current barrier crash tests involve a 79,400-lb. GVW tractor-van combination and a 79,400-lb. GVW tractor-tank-trailer combination.

## **2.4 Route-Based Analysis**

The USDOT study team originally planned a route-based analysis as part of this effort. The goal was to compare the safety of routes that operate scenario vehicles with routes that operate control configuration vehicles while controlling for such variables as total AADT, truck percentage, roadway type (i.e., functional class), number of lanes, urban/rural location, speed limit, etc. The outcome variable was to be truck crashes per mile of truck exposure. Note that this is a comparison of crashes per mile for all trucks, including the alternative configurations, with crashes per mile for all trucks where the scenario vehicles are not allowed to operate. Note that, unlike the State analyses described above, this is not a comparison of a specific scenario vehicle to a specific control vehicle. The basic method was to:

1. Identify States that allow a certain alternative truck configuration on certain routes, but do not allow the same alternative configuration on other similar routes.
2. Identify the target and non-target routes or route segments.
3. Obtain crash data and total AADT, total truck percentage, and other inventory variables for each route section to be studied;
4. Estimate safety performance functions to compare the safety of the target route segments used by the alternative configuration vehicles with route segments not used by those alternative vehicles.

### ***Choice of State Data Bases***

Again, this search was for States allowing a specific alternative truck configuration on certain route segments along with similar routes that did not allow the operation of that configuration. The search for potential States occurred at the same time as the search for the other State-based analyses, again examining crash and exposure data. The initial review identified Ohio, Indiana, Maine, and Louisiana as possible candidates for this method. In Ohio and Indiana, triple-trailer configurations are allowed on Interstate toll roads but not on other Interstates. In Maine, the 3-S3 alternative semitrailer configuration has been allowed on the Maine Turnpike since 2008 or

earlier, but not on other Interstates until a pilot program began in 2010. In Louisiana, heavier semitrailer configurations are allowed on Interstates during the 100-day harvest season to accommodate the transport of sugarcane. Hence, for this State, the “baseline” would be the Interstate roads during the non-harvest months.

Further exploration eliminated Ohio and Indiana from the analysis because more than one alternative truck configuration operated on the Turnpike routes. In both cases, both triple-trailer configurations and other LCV’s (e.g., Rocky Mountain Doubles) were allowed to operate. The comparison would then have changed from the desired triple trailer vs. twin-trailer configurations comparison to a comparison of all LCVs vs. twin-trailer configurations, a comparison that is not in any of the scenarios guiding this research. Louisiana was eliminated due to problems in obtaining a clear listing of routes and dates they were used by the alternative truck configurations.

This left Maine as the only State further considered since Maine (ME) did allow a single alternative truck configuration on a route. In ME, the alternative truck configuration is the Scenario 3 configuration, which was limited to a maximum GVW of 100,000 lbs., very close to the 97,000-lb. target. The target route would be the Maine Turnpike, which is part of I-95 from Kittery at the New Hampshire border north to Augusta in the middle of the State. This route did not allow other LCVs. The control route would be the remainder of I-95, north of the Turnpike section, a route that allowed twins, but not other LCVs. Data from 2008-2009 were to be analyzed since the alternative truck configurations were allowed on the Turnpike but not on the remainder of I-95 during these years.

Unfortunately, exploration of the Maine data from the HSIS system indicated that no truck percent or truck AADT was available. Maine DOT staff was contacted to determine if truck volumes or percentages for 2008-09 were available in any other files, but no such files existed in a format that could be linked with Turnpike and other I-95 sections in the HSIS ME inventory file. Thus it was not possible to conduct the route-based analysis.

## **2.5 Fleet Analysis**

### ***Background***

The study team also investigated the availability of fleet data for use in the safety analysis. Early on in this study, the team acknowledged the advantages of obtaining crash data from carriers who operate the vehicle configurations in question, especially when there is uncertainty concerning the availability of accurate State-level crash information for specific configurations. Further, the team also recognized that for triple-trailer configurations, the vast majority of the operations (about 90 percent of vehicle miles) occur with a comparatively small number of carriers (about six). Thus, working through American Trucking Associations (ATA) and the American Transportation Research Institute (ATRI), contacts were established for crash and operations data reflecting triple-trailer and twin-trailer configuration operations (i.e., two 28.5 ft. trailers) as well as alternative configurations with legally permitted divisible loads (i.e., those regularly operating at over 80,000 lbs. GVW).

Two types of analyses were proposed: 1) a comparison of safety for the triple-trailer configuration (i.e., three 28.5 ft. trailers) compared to that for the double-trailer configuration

(two 28.5 ft. trailers) and 2) a comparison of the Scenario 2 and 3 configurations with that of the 80,000-lb. control single configuration.

The study team proposed a common approach for the analysis of both the triple-trailer configurations and the Scenario 2 and 3 configurations. Crash data would consist of USDOT-reportable crashes, as these are most consistently reported and known to USDOT; discussions with all trucking industry representatives indicated that this was a reasonable request. Exposure to risk data was needed for all routes in question – either number of dispatches or vehicle miles traveled. To be consistent with the use of safety performance functions, it was critical that we obtain data on road segments with operations that result in zero crashes in a year as well as those with crash events. In addition, segment-based crash and exposure data were required. The intention was to use the fleet-based analysis to supplement analyses at the State level.

Trucking firms were assured that their data would be protected from release and unwarranted exposure. Data sharing agreements were established between carriers and the University of North Carolina, the custodian of the fleet data. In addition, data and model accessibility guidelines were developed to inform carriers of the degree to which their data would be held confidential within the team. The data accessibility guidelines are summarized in **Table 18**.

**Table 18: Study Data/Model Accessibility and Data Custody Guidelines.**

|   |   |
|---|---|
| <p><b>Data/Model Accessibility Guidelines</b></p> | <ul style="list-style-type: none"> <li>• <b>In Summary</b> – The study data/models used to conduct analysis will be available to USDOT and third parties. The availability of some data/models may have specific requirements: usage agreement specific to study only, usage fee to vendor, and compliance with a Non-Disclosure Agreement (NDA) or Data Agreement (DA).</li> <li>• <b>Safety Carrier Data</b> – Proprietary individual carrier safety data will be available to the study safety team under a NDA/DA and will not be available to the USDOT and third parties. The study safety team will blend the individual carrier data for use in the safety analysis. This blended database will be available to the USDOT and third parties, per the NDAs/DAs’ requirements.</li> <li>• <b>Truck Flow Data</b> – The truck flow data used by the study team will be a county-to-county disaggregation of USDOT’s Freight Analysis Framework database that will be available to third parties.</li> <li>• <b>Vehicle Stability and Control Model</b> – The vehicle stability and control (VSC) analysis will use the commercially available TruckSim® model. The TruckSim® model is available to third parties for a fee.</li> <li>• <b>Truck Cost Data</b> – The proprietary truck cost data used by the study team will be made available to USDOT and third parties.</li> </ul> |
| <p><b>Data Custody Guidelines</b></p>             | <ul style="list-style-type: none"> <li>• <b>Safety Carrier Data</b> - Proprietary individual carrier safety data will have an established and documented path of communication and control between the carrier and the study safety team. The study safety</li> </ul>   |

|  |   |
|--|---|
|  | <p>team will keep custody of the carrier data per a NDA/DA (between the carrier and the study team) with direct transfer of the individual carrier data between the carrier and the CTSW study team. The University of North Carolina (UNC) and the individual carrier will be parties to a NDA/DA for usage and handling of the carrier safety data. The study team will not share the names of the individual carriers outside of the study team.</p> <ul style="list-style-type: none"> <li>• <b>Truck Cost Data</b> – An NDA/DA between the vendor and FHWA limits the geographic detail of rate data.</li> </ul> |
|--|---|

Despite these actions, several carriers declined to participate due to concerns about protection of their anonymity. Insufficient data were obtained from operators of alternative six-axle combination truck configurations proposed in this study, so the study team did not attempt analyses of these data. Data were obtained from several operators of triple-trailer configurations, though they were not at the level of detail anticipated. The lack of precision resulted in a more aggregated estimate of the triple-trailer configurations’ safety performance compared to that of the double-trailer configurations than was originally planned.

**Methodology**

The study Safety Project Plan (see **Appendix B**) proposed a crash analysis on a segment-by-segment basis. This approach is similar to that used in contemporary highway safety studies. While some data were available to support such an approach, the carriers were unable to supply other critical data. Carriers provided a set of individual crash records describing the crashes among triple-trailer and double-trailer configurations (with some variability from carrier to carrier). The crash records for the triple-trailer configuration were generally consistent with the data requested (see **Table 19**). In each case, however, there was no information supplied about road segments where the triple-trailer configurations operated with no crashes; this seriously constrained the analyses that could be performed.

**Table 19: Summary of Fleet Data Request**

|    |   |
|----|---|
| 1  | Date of crash – would prefer historical data back to 2006 if possible.  |
| 2  | Time of Day   |
| 3  | Location of crash (street address; interstate highway; State route number and milepost or other location reference) |
| 4  | Weight of fleet vehicle involved  |
| 5  | State   |
| 6  | Number injured in truck   |
| 7  | Number injured in other involved vehicle  |
| 8  | Number killed in truck  |
| 9  | Number killed in other involved vehicle   |
| 10 | Truck driver age  |
| 11 | Truck driver experience with firm   |

|    |   |
|----|---|
| 12 | Type of collision: Truck rear-ending passenger vehicle; Passenger vehicle rear ending truck; Truck crossing center median (head on); Passenger vehicle crossing center median (head on); Truck striking passenger vehicle (other); Passenger vehicle striking truck (other); Truck single-vehicle crash |
| 13 | Driver-related factors in crash   |
| 14 | Vehicle-related factors in crash  |
| 15 | Roadway/weather related factors in crash  |
| 16 | Seat belt use: Truck driver; Passenger vehicle driver and passengers  |
| 17 | Driver and vehicle violations – truck   |
| 18 | Driver-related factors - passenger car  |

Notes:

- ◆ For crashes involving double-trailer configuration, the same data listed above for each crashes involving double trailer combinations occurring in the following States on Interstate highways only is needed. States of interest are: Idaho, Indiana, Kansas, Kentucky, Louisiana, Maine, Michigan, Nevada, Ohio, Oregon, Utah, Washington.
- ◆ For each of these States, the record of DOT-reportable double-trailer configuration crashes for the years 2006-2013 is needed.
- ◆ For road segments (or terminal pairs) with no crashes, the number of vehicles (or vehicle miles) for each year, the route and the State is needed. It is essential that this information is available to conduct the modeling intended under this part of the study.

The carriers had difficulty in providing the exposure data for fleet-owned trucks in the selected States for the requested years. The primary difficulty was that carriers were not accustomed to analyzing safety based on road segment of travel, so their information systems could not readily supply the data requested. Crash report data and aggregate exposure data from some carriers was received. These data enabled the calculation of aggregate crash rates for triple trailer and double-trailer configurations (contained in Fleet-based Analysis Results section), but the data were insufficient to allow for a more detailed comparison of configuration crash experience.

Analytical Approach

The proposed analysis approach was to compare the safety performance of triple-trailer configurations and the control vehicle (i.e. a double-trailer configuration with two 28.5 foot trailers) used in the comparative analysis on the same or similar roadway segments. The analysis was based on the procedure commonly used in road safety studies and contained in the Highway Safety Manual (AASHTO, 2010). It was applied on a road segment basis as in the State analysis described previously.

This is a new approach not previously used in motor carrier studies (based on the completed Desk Scan – see **Appendix A**) although it has been broadly used in road safety management for several years. This approach was actively discussed during the second meeting with the NAS Peer Review Panel. Panelist comments recognized the challenges posed by the need to associate truck size and weight with crash outcomes. Had this approach been implemented, it would have allowed a more disaggregate approach to understanding truck crashes and thus provided better insight about the role of vehicle configuration. Unfortunately, sufficient data could not be consistently obtained to support a comprehensive analysis.



### ***Fleet Rate Analysis Results***

Carrier-provided data were inconsistent in content and depth. In most cases, complete crash records were available, but these were not matched to exposure so it was not possible to undertake the analysis as planned. In many cases there was no exposure data provided; in some cases where it was provided, it was at an aggregate level. While the required data were not obtained from a range of fleets, there were sufficient data to allow the computation of some comparisons between the safety performance of triple-trailer and twin-trailer configurations.

Based on carrier-supplied data, the following crash rates were computed:

- Twin-trailer configurations – 0.516 involvements per million vehicle miles
- Triple-trailer configurations – 0.355 involvements per million vehicle miles

These estimates were obtained using data from 2006 through 2013. Caution is advised in interpreting these numbers as a difference in crash rates due to several confounding factors:

- The study team was unable to obtain exposure estimates at a detailed functional class level as planned. This restricted the ability to produce rates consistent with the Scenario 5 and 6 vehicle configurations (i.e. triple-trailer configurations).
- Differences in the usage patterns of triple trailer and twin-trailer configurations are very likely to influence the crash estimates shown (e.g., the road types where the configurations were operated). In addition, the total exposure to risk for the two vehicle types is quite different: exposure for twin-trailer configurations exceeds 20 billion vehicle miles, while that for triple-trailer configurations is less than 100 million vehicle miles. The variability in crash frequency will also be higher, in general, for the vehicle class with lower exposure (i.e. triple-trailer configurations). This raises a question about whether the difference in the two rates is “statistically significant”; an issue which cannot be statistically tested given the nature of the data.

USDOT has decided that these two rates should be presented, but that they ***cannot be considered*** indicative of a difference in crash experience. At the same time, it should be noted that the fleet rates are in line with the rates produced for Idaho and the Kansas Turnpike.

***Fleet Severity Analysis***

While the level of detail for the fleet data hindered the study team’s ability to produce crash rates from the fleet data, there is an opportunity to compare the severity of crashes involving twin and triple combinations. The study team included data from line-haul crashes only (i.e. no pick-up and delivery events included). These data were obtained from carriers with crash involvement details including:

- Crash date
- Vehicle type (twin or triple combination)
- Crash severity which includes 4 fields:
  - Number of fatalities on truck
  - Number of fatalities in other vehicles
  - Number of injuries in truck
  - Number of injuries in other vehicles
- Type of collision

These data were compiled into three summary tables, one for injuries involving all involved vehicles and all crashes, a second involving injuries to truck occupants only, and the third for injuries involving occupants of other vehicles. The data are presented as follows in **Tables 20, 21** and **22** using a structure similar to the severity analysis conducted with the State data. The same Fisher’s exact test was used in analyzing the differences between the pairs of distributions.

**Table 20** involves injury severity for both truck and non-truck occupants for all Interstate crashes. The Fisher’s exact test failed to reject the null hypothesis. The conclusion of the test is that there is insufficient evidence to differentiate the severity distribution of twin-trailer and triple-trailer configurations considering all crashes in the data set.

**Table 20: Severity of Interstate involvements for Twin-trailer and Triple-trailer Configurations from Fleet Data Including All Injury Crashes (Urban and Rural Combined).**

|                          | Severity of Involvement | Truck Configuration |            |                 |            |
|--------------------------|-------------------------|---------------------|------------|-----------------|------------|
|                          |                         | Twin Trailers       |            | Triple Trailers |            |
|                          |                         | Frequency           | Percentage | Frequency       | Percentage |
| <b>Rural &amp; Urban</b> | Fatal                   | 18                  | 2.40       | 1               | 1.79       |
|                          | Injury                  | 219                 | 29.16      | 14              | 25.00      |
|                          | Non-Injury              | 514                 | 68.44      | 41              | 73.21      |
|                          | Total                   | 751                 | 100.00     | 56              | 100.00     |

**Table 21** is similar to **Table 20** except a crash is entered as an injury event only if the occupant of the truck was injured. The Fisher’s exact test again indicated no statistically significant difference in the severity distributions.

**Table 21: Severity of Interstate Involvements for Twin-trailer and Triple-trailer Configurations from Fleet Data Including Crashes with Injuries to Truck Occupants Only (Urban And Rural Combined).**

|                          | Severity of Involvement | Truck Configuration |            |                 |            |
|--------------------------|-------------------------|---------------------|------------|-----------------|------------|
|                          |                         | Twin Trailers       |            | Triple Trailers |            |
|                          |                         | Frequency           | Percentage | Frequency       | Percentage |
| <b>Rural &amp; Urban</b> | Fatal                   | 6                   | 0.80       | 0               | 0.00       |
|                          | Injury                  | 84                  | 11.19      | 7               | 12.73      |
|                          | Non-Injury              | 661                 | 88.02      | 48              | 87.27      |
|                          | Total                   | 751                 | 100.00     | 55              | 100.00     |

**Table 22** involves the most severe injury severity for non-truck occupants in Interstate crashes where a twin-trailer or triple-trailer configurations and a non-truck were involved. Twin-trailer configurations appear to be involved in less severe crashes, and the statistical test indicated a significant difference at the  $p=0.02$  level.

**Table 22: Non-truck Occupant Severity in Interstate Crashes Involving a Twin Trailer or Triple-trailer configuration with a Non-truck (Urban and Rural Combined).**

|                          | Severity of Involvement | Truck Configuration |            |                 |            |
|--------------------------|-------------------------|---------------------|------------|-----------------|------------|
|                          |                         | Twin Trailers       |            | Triple Trailers |            |
|                          |                         | Frequency           | Percentage | Frequency       | Percentage |
| <b>Rural &amp; Urban</b> | Fatal                   | 7                   | 1.46       | 2               | 14.29      |
|                          | Injury                  | 164                 | 34.31      | 5               | 35.71      |
|                          | Non-Injury              | 307                 | 64.23      | 7               | 50.00      |
|                          | Total                   | 478                 | 100.00     | 14              | 100.00     |

## **2.6 Summary of Crash Data Results**

The above sections have described the different analyses conducted using crash data from both State DOTs and from carriers. **Table 23** summarizes those findings by type of analysis within each Scenario.

Concerning all the analyses conducted and attempted, several concluding statements may be made. Note that all these findings are related to Interstate roads only. Recall, as previously described, a key component of constructing the exposure data was the data derived from FHWA's Weigh-in-Motion (WIM) data base. This data was essential for conducting an assessment of crash information among trucks by type and various gross vehicle weight. The WIM data was predominately available for the Interstate System but was very limited for other National Highway System (NHS) roadways. This data coverage issue constrained the analysis to Interstate System roadways.

- **It was not possible to conduct crash analyses based on involvement of vehicles by actual weight. These data were not available in any State crash records, nor were weight data for combination vehicles consistently available in fleet crash records.**

- Given the lack of weight data, alternative methods applied to the State-level crash analysis used axle count, number of trailers, and the maximum allowable GVW to identify possible control and alternative truck configurations. A small number of States met these criteria and, among them, the maximum GVW for alternative configurations differed from the desired Scenario targets in some States. As noted in the first column of Table ES-2, the resulting crash rate and regression analyses for Scenario 2 are based on Washington data, the Scenario 3 analyses on Idaho and Michigan data, the Scenario 5 analysis on Idaho data and the Scenario 6 analyses on Kansas Turnpike data.
- In the three States where data could be analyzed, the crash involvement rate for the six-axle alternative configurations is consistently higher than the rate for the five-axle control vehicle. This consistency across States lends validity to this finding.

**Table 23: Summary of Crash-Data Analysis Findings Categorized by Scenario, Data Source and Analysis Type.**

| Scenario  | Data and Analysis Type  | Results  |
|---|---|--|
| <p><b>Scenario 2</b></p> <p>Target – 3-S3, 91,000 lb. semitrailer vs. 3-S2, 80,000 lb. semitrailer</p> <p>Limited State Crash Analysis – six-axle semitrailer with maximum allowable GVW of 91,000 lb vs. five-axle semitrailer with maximum allowable GVW of 80,000 lb (Washington data)</p> <p>Fleet Analysis – No fleet analysis conducted for this Scenario</p>                           | State Involvement Rates   | <ul style="list-style-type: none"> <li>Crash rates for the six-axle alternative truck configuration in Washington are significantly higher than the five-axle control truck rates. (See <b>Table 8.</b>) It was not possible to draw national conclusions or present findings concerning national crash rates due to a lack of relevant crash data.</li> </ul>   |
|   | State Regression Modeling   | <ul style="list-style-type: none"> <li>Effect of AADT on crash rate in Washington is similar for the six-axle alternative truck configuration and the five-axle control vehicle.</li> </ul>  |
|   | State Injury Severity Distributions   | <ul style="list-style-type: none"> <li>No differences were found between the involvement severities of the alternative and control trucks.</li> </ul>  |
|   | State Longitudinal Barrier Analysis   | <ul style="list-style-type: none"> <li>The critical variables needed for this analysis were not found in the Washington crash data. No analysis was possible.</li> </ul>   |
|   | Fleet Crash Rates   | <ul style="list-style-type: none"> <li>No analysis could be conducted due to the small sample size of 3-S3 crashes in the fleet data received.</li> </ul>  |
|   | Fleet Severity Distributions  | <ul style="list-style-type: none"> <li>No analysis could be conducted due to the small sample size of 3-S3 crashes in the fleet data received.</li> </ul>  |
| <p><b>Scenario 3</b></p> <p>Target – 3-S3, 97,000 lb. semitrailer vs. 3-S2, 80,000 lb. semitrailer</p> <p>Limited State Crash Analysis – six-axle semitrailer with maximum allowable GVW of 105,500 lb vs. five-axle semitrailer with maximum allowable GVW of 80,000 lb (Idaho data) and 86,000 lb (Michigan data)</p> <p>Fleet Analysis – No fleet analysis conducted for this scenario</p> | State Crash Involvement Rates   | <ul style="list-style-type: none"> <li>With one exception (Idaho rural Interstate), crash rates for the six-axle alternative truck configuration are noticeably higher than the crash rates for the five-axle control vehicle in both Michigan and Idaho. (See <b>Table 8.</b>) It was not possible to draw national conclusions or present findings concerning national crash rates due to a lack of relevant crash data.</li> </ul>  |
|   | State Regression Modeling   | <ul style="list-style-type: none"> <li>Michigan crash involvements of the six-axle alternative truck configuration increase at a much faster rate as AADT increases compared to five-axle controls.</li> <li>No reliable model could be developed for Idaho due to sample size issues.</li> </ul>  |
|   | State Injury Severity Distributions   | <ul style="list-style-type: none"> <li>In Idaho, the six-axle alternative truck involvements appear to be less severe than the five-axle involvements on rural Interstates (p=0.07), urban Interstates (p=0.14) and when urban and rural are combined (p=0.01). In Michigan, the six-axle alternative truck involvements on rural Interstates appear to be less severe than five-axle involvements (p=0.14), but there are no differences in the distributions for the urban or combined situations. (See <b>Tables 13 and 14.</b>)</li> </ul> |
|   | State Longitudinal Barrier Analysis   | <ul style="list-style-type: none"> <li>The small samples of six-axle alternative vehicles involved in barrier impacts in Idaho (i.e., three) and Michigan (i.e., one) made drawing conclusions concerning behavior after impact impossible.</li> </ul>   |
| Fleet Crash Rates   | <ul style="list-style-type: none"> <li>No meaningful analysis could be completed due to the very small sample size</li> </ul> |  |

Highway Safety and Truck Crash Comparative Analysis Technical Report

| Scenario   | Data and Analysis Type              | Results   |
|--|-------------------------------------|---|
|  |                                     | of 3-S3 crashes in the fleet data received.   |
|  | Fleet Severity Distributions        | <ul style="list-style-type: none"> <li>No meaningful analysis could be completed due to the very small sample size of 3-S3 crashes in the fleet data received.</li> </ul>   |
| <p><b>Scenario 5</b></p> <p>Target – 2-S1-2-2, 105,500 lb. triple vs. 2-S1-2, 80,000 lb. twin</p> <p>Limited State Crash Analysis – Triple-trailer configurations with maximum allowable GVW of 105,500 lb vs. five- and six-axle double-trailer configurations with maximum allowable GVW of 80,000 lb (Idaho data)</p> <p>Fleet Analysis – Triple-trailer configurations with unknown GVW vs. Twins with unknown GVW</p> | State Crash Involvement Rates       | <ul style="list-style-type: none"> <li>The crash involvement rate for triple-trailer combinations in Idaho is lower than for the twin-trailer combinations. The differences are marginally significant for rural Interstates and rural and urban Interstates combined. (See <b>Table 9</b>.) It was not possible to draw national conclusions or present findings concerning national crash rates due to a lack of relevant crash data.</li> </ul>  |
|  | State Regression Modeling           | <ul style="list-style-type: none"> <li>The sample size of triple-trailer configuration crashes in Idaho (n=15) was too small for reliable regression modeling.</li> </ul>   |
|  | State Injury Severity Distributions | <ul style="list-style-type: none"> <li>The Idaho triple-trailer configurations involvements appear to be somewhat less severe than the twin-trailer configurations involvements on rural Interstates (p=0.09). No differences are seen on urban Interstates or when urban and rural are combined. (See <b>Table 15</b>.)</li> </ul>   |
|  | State Longitudinal Barrier Analysis | <ul style="list-style-type: none"> <li>The small sample of twins (one) and triple-trailer configurations (none) involved in longitudinal barrier impacts in Idaho made drawing conclusions concerning behavior after impact impossible.</li> </ul>  |
|  | Fleet Crash Rates                   | <ul style="list-style-type: none"> <li>While overall twin trailer and triple-trailer configurations crash rates were calculated, there was no way to control for difference in road types where each operated (e.g., Interstate vs. non-Interstate). Thus the rates cannot be viewed as indicative of a difference in crash experience. (See Section 2.5 Fleet Analysis.)</li> </ul>  |
|  | Fleet Severity Distributions        | <ul style="list-style-type: none"> <li>There was no evidence of a difference in injury severity between twin and triple-trailer configurations crashes for either all occupants or for truck occupants. Non-truck occupants were less severely injured in crashes with twin trailers vs. crashes with triple-trailer configurations (p=0.02). (See <b>Tables 20-22</b> and related text.)</li> </ul>  |
| <p><b>Scenario 6</b></p> <p>Target – 2-S1-2-2, 129,000 lb. triple vs. 2-S1-2, 80,000 lb. twin</p> <p>Limited State Crash Analysis – Triple-trailer configurations with maximum allowable GVW of 120,000 lb vs. five- and six-axle</p>  | State Crash Involvement Rates       | <ul style="list-style-type: none"> <li>The overall rate (for combined rural and urban sections) for twin trailer and triple-trailer configurations on the Kansas Turnpike is almost identical. In rural sections, the rate for triple-trailer configurations is slightly higher, and in urban sections, the rate for triple-trailer configurations is lower. The number of both twin trailer and triple-trailer configuration crashes is very low and none of the differences are even marginally significant. (See <b>Table 10</b>.) It was not possible to draw national conclusions or present findings concerning national crash rates due to a lack of relevant crash data.</li> </ul> |
|  | State Regression Modeling           | <ul style="list-style-type: none"> <li>The sample size of triple-trailer configurations crashes on the Kansas</li> </ul>  |

Highway Safety and Truck Crash Comparative Analysis Technical Report

---

| Scenario   | Data and Analysis Type              | Results   |
|--|-------------------------------------|---|
| double-trailer configurations with maximum allowable GVW of 80,000 lb (Kansas Turnpike data)<br><br>Fleet Analysis – Triple-trailer configurations with unknown GVW vs. Twins with unknown GVW |                                     | Turnpike (n=10) was too small for reliable regression modeling.   |
|  | State Injury Severity Distributions | <ul style="list-style-type: none"> <li>Because of the small sample sizes, it was not possible to draw conclusions concerning severity differences. (See <b>Table 16</b> and related text.)</li> </ul> |
|  | State Longitudinal Barrier Analysis | <ul style="list-style-type: none"> <li>The critical variables needed for this analysis were not found in the Kansas crash data. No analysis was possible.</li> </ul>                                  |
|  | Fleet Crash Rates                   | <ul style="list-style-type: none"> <li>See results under Scenario 5.</li> </ul>   |
|  | Fleet Severity Distributions        | <ul style="list-style-type: none"> <li>See results under Scenario 5.</li> </ul>   |

- As has been noted in other research, the use of rates based on truck crashes per truck VMT does not capture complete information since that truck-crash rate can vary based on changes in total AADT. In this study, this issue has been addressed using regression modeling. There was some indication in the regression modeling that the crash involvements of six-axle alternative configurations increase at a much faster rate with increase in exposure when compared to five-axle semitrailers. This needs to be further verified in future studies in other States.
- Comparisons of crash injury severity distributions for the six-axle with the five-axle semitrailer configurations showed some indication of reduced severity for six-axle configurations. The Washington data were unable to identify differences for the Scenario 2 distributions. The Idaho data for the Scenario 3, 97,000-lb. configuration indicated that the six-axle alternative truck involvements appear to be less severe than the five-axle involvements on rural Interstates, urban Interstates, and when urban and rural are combined. The Michigan data for the same Scenario indicated that the six-axle alternative truck involvements on rural Interstates appear to be less severe than five-axle involvements, but no differences in the distributions for the urban or combined situations.
- Based on Idaho data, the Scenario 5 crash involvement rates for triple-trailer combinations were lower than the rates for the control double configuration on both rural Interstates and rural and urban Interstates combined, and the differences were marginally significant. (See **Table 9**.) No differences were found in the crash involvement rates for the Scenario 6 triple-trailer configuration compared with the control double configuration based on the Kansas Turnpike data, even at the  $p=0.15$  level of significance. (See **Table 10**.) In both cases, the small sample of triple-trailer configuration crashes makes drawing conclusions difficult.
- The results of the severity distribution analyses for triple-trailer and twin-trailer configurations were mixed. The Idaho Scenario 5, 105,500-lb. triple-trailer configurations appeared to be in somewhat less severe than the control double configuration. No differences were found in severity distributions for the triple trailer compared with the control double in the Scenario 6, 129,000-lb. Kansas Turnpike data. While the fleet data indicated no differences in severity distributions for twin-trailer and triple-trailer configurations both for all occupants and for truck occupants, there was a significant difference in the severity distributions of non-truck occupants, who experienced less severe injuries in crashes with twin-trailer configurations. Again, the small sample size of crashes for the triple-trailer configuration constrains the ability to form strong conclusions.
- Due to data issues primary related to either missing data or small samples of the alternative vehicles, planned analyses that could not be completed included the regression modeling for Idaho alternative configurations, the regression modeling for both Idaho and Kansas triple-trailer configurations, the route-based analysis, and the fleet crash rate analyses for the alternative configurations.



## **CHAPTER 3 - ANALYSIS OF SAFETY VEHICLE STABILITY AND CONTROL**

This analysis compares the stability and control characteristics of the control and six scenario vehicles, which were run through specific maneuvers in a computer simulation. This analysis, a direct comparison between vehicles in idealized situations, was conducted to identify vehicle stability and control issues for the six scenario configurations. It complements the results of the other analyses, which used crash involvement statistics from various sources.

Additional information developed under a project to assess braking performance for certain trucks under certain conditions was included to complement the simulation-based work conducted for this study. This braking performance project was conducted by the Federal Motor Carrier Safety Administration (FMCSA) and Oak Ridge National Laboratories (ORNL).

### **3.1 Vehicle Stability and Control Scope**

This analysis compared the stability and control properties of the six scenario vehicles with their two corresponding control vehicles. Models of the eight vehicles were run in computer simulations through a series of five maneuvers, each designed to challenge a specific aspect of the vehicle stability. The maneuvers quantified the performance in intersections at low speed and on a highway curve at high speed. Braking performance and stability were simulated on a straight road and a curved road for both fully functioning brakes and for two types of brake malfunction. The final maneuver examined performance in an avoidance maneuver at highway speed. To limit the scope of the analysis, each maneuver, except the avoidance maneuver, was run at one simulated speed and one radius of curvature. The idealized situations that were simulated could occur on any highway network. They are not specific to a particular network of where the vehicle might be allowed to operate.

This analysis provided a direct comparison of the stability of the vehicles in the selected maneuvers. Without data on how frequently these situations are encountered on public roads, these results cannot be used in any crash data estimates. Thus, this analysis complements the foregoing crash data analyses, but its results cannot be combined with theirs.

As noted, additional results based on field testing conducted by FMCSA and ORNL produced useful, relevant information on vehicle stopping distance and its relationship to gross vehicle weight. These results were included in this study to supplement the results produced through simulation modeling. FMCSA and ORNL tested a 3S-2 tractor flatbed semi-trailer configuration under various loading conditions (various gross vehicle weight conditions) with regard to stopping distances. Results from the FMCSA/ORNL project are generally consistent with results produced in the computer simulation analysis.

### **3.2 Vehicle Stability and Control Methodology**

The methodology in this analysis was to develop computer models of the vehicles, simulate them through a series of maneuvers, and observe trends in objective performance parameters.

### *Analytical Approach*

As discussed in the Chapter 1 – Introduction, the USDOT selected two control vehicles and six scenarios with input from stakeholders. The maneuvers for study were based on those used in prior truck size and weight studies and on standardized tests. They were selected to challenge the vehicles in a variety of ways that might reflect on their relative safety performance.

### *Research Approach for the Vehicle Stability and Control Analysis*

The simulations were conducted with TruckSim<sup>®</sup> (versions 8.1 and 8.2), a commercially available and widely accepted heavy truck modeling package.

The vehicles were simulated through defined maneuvers to evaluate their performance. The maneuvers are based on established test procedures and prior research so that the results are comparable with those of other studies. Table 24 lists the maneuvers that were used to evaluate the vehicles as well as the performance metrics that were extracted from each maneuver and the crash type that each is intended to assess. The maneuvers are illustrated in the results section, where descriptions and sketches of each path are presented along with sample results. Complete technical descriptions of the maneuvers and analysis are in **Appendix C**.

The performance metrics are objective measures that can be used to compare the behavior of vehicles. Each metric can be related to one or more kinds of crashes, so the performance metrics are relative measures of the safety and stability of vehicle configurations. Results from these highly idealized maneuvers, however, cannot be quantitatively related to crash involvement in actual use. The performance metrics are:

- a) **Stopping Distance.** Perhaps the most commonly measured performance metric is stopping distance. A truck with a longer stopping distance is more likely to be involved in forward collisions. The regulation for air brakes, as legislated in Federal Motor Vehicle Safety Standard (FMVSS) No. 121, provides a straight-line stopping distance test (see S5.3.1.1. of the standard). The brake-in-a curve test referenced in S5.3.6.1 does not include a stopping distance criterion, but the stopping distance in this test was a performance metric.
- b) **Maximum Path Deviation.** The brake-in-a-curve test referenced in FMVSS No. 121 S5.3.6 requires that the truck remain within a 12-ft. lane during a hard braking stop on a slippery road surface. If part of a truck leaves its lane, it may strike a vehicle in an adjacent lane. If the truck is on a narrow road, it may strike roadside objects or leave the pavement entirely, possibly leading to a rollover.

**Table 24: Simulated Vehicle Maneuvers.**

| Name                       | Description  | Comments  | Performance-based metrics |                   |                         |   |                        |                             |
|----------------------------|--|---|---------------------------|-------------------|-------------------------|---|------------------------|-----------------------------|
|                            |  |   | Metric                    | Stopping Distance | Maximum Path Deviation  | Off-tracking                                  | Rearward Amplification | Lateral Load Transfer Ratio |
|                            |  |   | Associated Crash Type     | Forward Collision | Sideswipe, Run-Off-Road | (see below)                                   | Sideswipe, Rollover    | Rollover                    |
| 1. Low-speed off-tracking  | 41 ft.-radius curve at 3.1 mph   | represents an intersection turn   |                           |                   |                         | low-speed (affects mobility at intersections) |                        |                             |
| 2. High-speed off-tracking | 1289 ft.-radius curve at 62 mph  | represents a curve on a highway   |                           |                   |                         | high-speed (requires wider lanes)             |                        |                             |
| 3. Straight-line braking   | Procedure of the 60-mph stopping distance test in S5.3.1.1 of FMVSS No. 121      | conducted with fully functioning brakes and with two brake malfunctions |                           | X                 | X                       |   |                        |                             |
| 4. Brake in a curve        | Procedure of the brake-in-a-curve test in S5.3.6.1 of FMVSS No. 121. 30 mph.     | conducted with fully functioning brakes and with two brake malfunctions |                           | X                 | X                       |   |                        | X                           |
| 5. Avoidance maneuver      | Single lane change similar to ISO 14791, lateral stability test methods. 50 mph. | run under multiple conditions   |                           |                   |                         | transient (leads to poor obstacle avoidance)  | X                      | X                           |

- c) **Off-tracking.** Off-tracking is the phenomenon of one or more trailers following a path different than the tractor. It can occur in different situations and have different consequences; for example, in an urban environment, the trailer's tires may ride up on the curb, potentially impacting pedestrian safety. Trucks have also been known to roll over at rural intersections when the trailer tires took a path into soft soil.

Low-speed off-tracking occurs when a truck makes a right-angle turn at an intersection and is also a factor, albeit less pronounced, on entrance and exit ramps. High-speed off-tracking occurs on a curve at a highway speed. The trailer may be inside or outside of the tractor's path, depending on the speed, loading, trailer length, and properties of the tires.

Transient off-tracking can occur during a lane change and is affected by loading, length, tire properties, and suspension properties as well. Transient off-tracking reflects the condition where the trailer is subject to greater lateral forces than the tractor and is associated with sudden, avoidance type maneuvers. The tires' ability to provide lateral forces plays a strong role in all off-tracking situations; their ability to maintain those forces as load shifts between left and right sides affects high-speed and transient off-tracking. Any kind of off-tracking can lead to trailer tires leaving the lane, which can lead to striking a vehicle in the adjacent lane or a tripped rollover where the higher profiled vehicle (truck) rolls over the lower profiled vehicle (car) during a lateral collision.

- d) **Rearward Amplification.** When a multi-trailer vehicle executes a sudden lane change, the rearmost trailer may overshoot the position selected by the driver. Poor lateral control can lead to the perils listed above. Rearward amplification is the ratio of the maximum value of a quantity (usually lateral acceleration or yaw rate) of a following vehicle to that of the tractor.
- e) **Lateral Load Transfer Ratio.** When an evenly loaded trailer is driving on a straight, level road, the loads on its tires are the same on both ends of the axle. In a steady or transient curve, the trailer will lean and some of the load will transfer from the tires on one end of the axle to those on the other end. If the load on one side falls to zero, the result can be a rollover. Mathematically, the formula for calculating the Lateral Load Transfer Ratio (LTR) of an axle is:

$$\text{LTR} = \frac{|FR - FL|}{FR + FL}$$

Where:

FL = the force on the left-side tires

FR = the force on the right-side tires

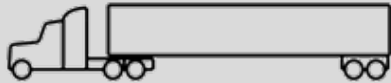
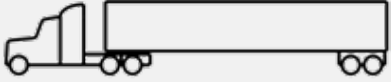
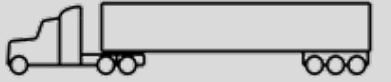
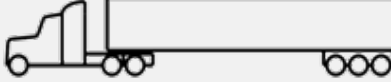
When an evenly loaded vehicle is driving straight on a level road, the LTR is 0. When the load on one end of the axle is completely removed, the ratio is 1 or -1. An absolute value of 1 means that a set of tires has momentarily lifted from the pavement, but it does not necessarily mean that the truck has rolled over.

#### Validating the Analytical Approach

The approach for this analytical approach was discussed in broad terms in the study's December 2013 and May 2014 public meetings along with other tasks. No comments were received.

Key Data and Models Used in the Analysis

**Figures 4 and 5** list the particulars of the eight models. The four single-trailer combinations are in the first page of the figure, and the four multi-trailer combinations are on the second page. On both pages, the top row is the control vehicle, which is the configuration allowed under current Federal size and weight limits.

| Scenario | Description  | Details                   |                      |      |                       |                |      |      |
|----------|--|---------------------------|----------------------|------|-----------------------|----------------|------|------|
| CS       | 5-axle vehicle   | <b>Axle Data</b>          |                      |      |                       |                |      |      |
|          |   | Axle Locations            | 0                    | 197  | 247                   | 739            | 789  |      |
|          |  | Actual Axle Loads         | 11.9                 | 17.0 | 16.9                  | 17.0           | 16.8 |      |
|          |  | <b>Whole Vehicle Data</b> |                      |      |                       |                |      |      |
|          |  | <b>GVW 80</b>             | <b>CG Height: 75</b> |      | <b>Wheelbase: 789</b> | <b>Axes: 5</b> |      |      |
| 1        | 5-axle vehicle   | <b>Axle Data</b>          |                      |      |                       |                |      |      |
|          |   | Axle Locations            | 0                    | 197  | 247                   | 739            | 789  |      |
|          |  | Actual Axle Loads         | 11.9                 | 18.9 | 18.8                  | 19.3           | 18.9 |      |
|          |  | <b>Whole Vehicle Data</b> |                      |      |                       |                |      |      |
|          |  | <b>GVW 88</b>             | <b>CG Height: 81</b> |      | <b>Wheelbase: 789</b> | <b>Axes: 5</b> |      |      |
| 2        | 6-axle vehicle   | <b>Axle Data</b>          |                      |      |                       |                |      |      |
|          |   | Axle Locations            | 0                    | 197  | 247                   | 689            | 739  | 789  |
|          |  | Actual Axle Loads         | 11.9                 | 16.2 | 16.1                  | 15.4           | 15.5 | 15.7 |
|          |  | <b>Whole Vehicle Data</b> |                      |      |                       |                |      |      |
|          |  | <b>GVW 91</b>             | <b>CG Height: 81</b> |      | <b>Wheelbase: 789</b> | <b>Axes: 6</b> |      |      |
| 3        | 6-axle vehicle   | <b>Axle Data</b>          |                      |      |                       |                |      |      |
|          |  | Axle Locations            | 0                    | 197  | 247                   | 689            | 739  | 789  |
|          |  | Actual Axle Loads         | 11.9                 | 17.2 | 17.1                  | 16.7           | 16.8 | 17.0 |
|          |  | <b>Whole Vehicle Data</b> |                      |      |                       |                |      |      |
|          |  | <b>GVW 97</b>             | <b>CG Height: 86</b> |      | <b>Wheelbase: 789</b> | <b>Axes: 6</b> |      |      |

**Figure 4: Vehicles Modeled – Single Trailer Combinations**

Note: Axle locations are measured in inches from the steer axle. Axle loads are in units of 1000 lb. Center of Gravity (CG) heights are inches.




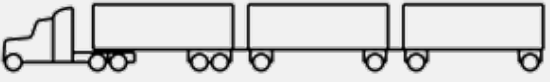
| Scenario | Description  | Details                   |  |                        |                |
|----------|--|---------------------------|--|------------------------|----------------|
| CD       |   | <b>Axle Data</b>          |  |                        |                |
|          |  | Axle Locations            | 0 158 421 530 793                            |                        |                |
|          |  | Actual Axle Loads         | 8.3 17.7 15.2 15.6 14.9                      |                        |                |
|          |  | <b>Whole Vehicle Data</b> |  |                        |                |
|          |  | <b>GVW 71.7</b>           | <b>CG Height: 91</b>                         | <b>Wheelbase: 793</b>  | <b>Axes: 5</b> |
| 4        |   | <b>Axle Data</b>          |  |                        |                |
|          |  | Axle Locations            | 0 158 481 590 913                            |                        |                |
|          |  | Actual Axle Loads         | 8.3 19.7 17.4 17.6 17.1                      |                        |                |
|          |  | <b>Whole Vehicle Data</b> |  |                        |                |
|          |  | <b>GVW 80</b>             | <b>CG Height: 92</b>                         | <b>Wheelbase: 913</b>  | <b>Axes: 5</b> |
| 5        |   | <b>Axle Data</b>          |  |                        |                |
|          |  | Axle Locations            | 0 158 421 530 793 902 1165                   |                        |                |
|          |  | Actual Axle Loads         | 8.5 17.5 15.1 15.7 15.2 15.6 15.0            |                        |                |
|          |  | <b>Whole Vehicle Data</b> |  |                        |                |
|          |  | <b>GVW 102.7</b>          | <b>CG Height: 91</b>                         | <b>Wheelbase: 1165</b> | <b>Axes: 7</b> |
| 6        |  | <b>Axle Data</b>          |  |                        |                |
|          |  | Axle Locations            | 0 197 247 439 489 598 861 970 1233           |                        |                |
|          |  | Actual Axle Loads         | 11.7 14.2 14.1 13.8 13.9 15.7 15.2 15.6 14.9 |                        |                |
|          |  | <b>Whole Vehicle Data</b> |  |                        |                |
|          |  | <b>GVW 129</b>            | <b>CG Height: 92</b>                         | <b>Wheelbase: 1233</b> | <b>Axes: 9</b> |

Figure 5: Vehicles Modeled – Multiple Trailer Combinations

As noted in previous sections, the axle arrangements and maximum allowed GVWs were selected by the USDOT. Under this guidance, the axle locations were set in the Project Plan (**Appendix B**) to correspond to typical commercial practice. The axle loads were set to distribute the weight evenly, according to the approach in the payload discussion that follows.

The model for the control single configuration was based on a model that was verified for a number of maneuvers in prior work (Rao et al. 2013a and Rao et al. 2013b). The other seven models were built by modifying this original model to add an axle, change the length of a trailer, and so forth. Properties have been compared with industry values where possible, but the new models have not been directly verified by new track tests.

### Key Assumptions and Limitations of the Simulation Modeling and Analysis

The USDOT study team made several assumptions to establish the scope of the work to be completed in this area of the study. Important assumptions included:

- All vehicles were dry van trailers with fixed, rigid loads.
  - Loads were centered laterally within the trailer. The position and distribution of the payload were selected according to payload density (discussed below).
- Steer axles had two tires, and all other axles had a set of two on each end.
- All multi-trailer combinations were modeled with a pintle hitch between the trailer and converter dolly—an “A train.”
- Simulations were run with dry pavement, except for the brake-in-a-curve test in Maneuver 4.
- In the two braking maneuvers, each of the vehicles in **Figure 4** and **Figure 5** was tested in three braking conditions:
  - Functioning foundation brake system with anti-lock braking system (ABS) on all axle ends. Normal TruckSim<sup>®</sup> brake and ABS model.
  - ABS malfunctioning on one axle or both axles of a tandem. The wheels may lock when brakes are applied.
  - Brake failure on one axle end or one tandem end. Braking torque is zero in the failure scenario.

The ABS malfunction and brake failures were modeled on the right ends of both drive axles for the single-trailer combinations. They were on the right end of the lead dolly in the multi-trailer combinations. The brake-in-a-curve maneuver was a left turn to create additional loading on the right wheels to evaluate the effect of the brake failures.

- Electronic stability control, as in the proposed new FMVSS No. 136, was not included. Vehicles equipped with electronic stability control were not included in the analysis since this equipment is not required under the existing FMVSS. This requirement is currently being progressed through a NHTSA proposed rulemaking that was not completed at the time that the analysis and modeling were performed for this study.

The assumption for the payload in the four single-trailer combinations was that a carrier with a hypothetical load is limited by current weight regulations. If the weight limit were to rise, the



carrier would stack the load higher in proportion to the allowed increase in weight. The payload in the models consisted of two uniform blocks that were positioned to provide the desired distribution of axle loads shown in **Figure 4**. The payload for the Scenario 1 88,000-lb. configuration is the same as that in the 80,000-lb. control vehicle, but slightly taller. With the addition of the third trailer axle in Scenario 2, the densities of the two hypothetical blocks were adjusted to move the center of gravity rearward and maintain a uniform distribution of loads across the axles. Again, with the increase in gross weight from 91,000 lbs. to 97,000 lbs. for Scenario 3, the hypothetical payload was made taller. Complete details are in **Appendix D**.

The assumption for the payload of the multi-trailer combinations for the control double, Scenario 4, and Scenario 5 was that they would be identical, varying only with the length of the trailer. Thus, and the trailers in Scenarios 4 and 5 all have the same floor loading. Scenario 4 (with double 33-ft. trailers) has the maximum allowed weight of 80,000 lb. With the same payload density on shorter trailers, the control double weighs 71,700 lbs. The weight set for the control double configuration was based on actual findings observed in the WIM data used in the Study. All three trailers in Scenario 5 are identical to the two trailers in the control double. The gross vehicle weight used for the Scenario 5 configuration was 102,700 based on data provided by the states as part of the Crash Analysis. Scenario 6, being much heavier, has loads that bring all of its axles up to the allowed maximum.

The payload densities and positions in the models were adjusted so that the axle loads were within two percent of the target values.

### ***Similarities and Differences from Prior TSW Studies***

This analysis follows the overall approach for the corresponding portions of prior truck size and weight (TSW) studies. It directly parallels them in that it compares key performance metrics for the control and study vehicles in various maneuvers. The two off-tracking maneuvers were taken directly from the 2000 Comprehensive Truck Size and Weight Study (2000 CTSW Study) (USDOT 2000, Vol. 2, pp. VI-34 and VI-35). Both the 2000 CTSW Study and the present study use computer simulations, rather than actual measurements, to evaluate the performance of the vehicles in the prescribed maneuvers.

The present study simulates two standard braking tests to quantify braking performance. This study is novel in that brake failures were added to analyze the directional stability of the vehicles during the braking maneuver.

The 2000 CTSW Study (USDOT 2000, Vol. 3, p. VIII-9) used a standard that is now canceled (SAE, 2000) for the evasive maneuver and the present study used a current standard (ISO, 2000). Both the 2000 and 2014 studies use a single lane change.

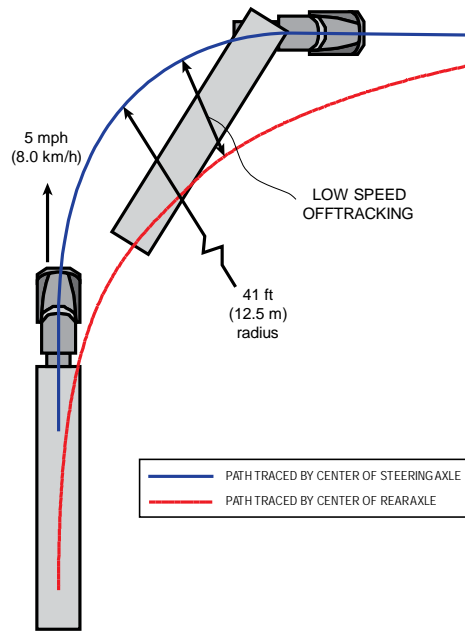
### **3.3 Vehicle Stability and Control Simulation Results**

This portion contains the results of the simulations. Sample graphs, sufficient to illustrate the results and analysis, are provided for each maneuver. Graphs of all results are in **Appendix F**.

The control single and double vehicles are the basis of comparison for the scenario vehicles. The results tables in this section show the control values in bold characters in shaded cells.

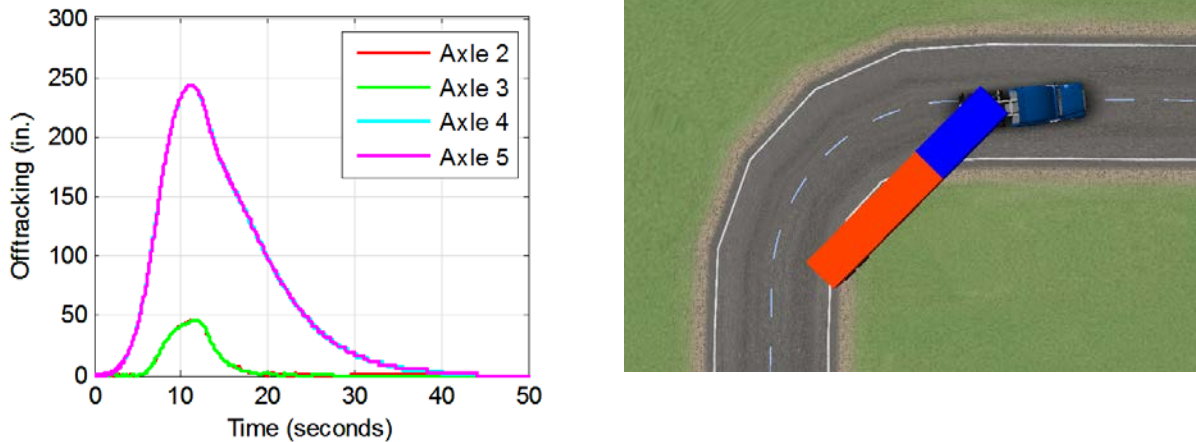
**Maneuver 1. Low-Speed Off-tracking**

Off-tracking is how much the path of an axle follows to the side of the path taken by the steer axle. Low-speed off-tracking is a measure of the tendency of a trailer to follow to the inside of a curve taken by the tractor. It is important for clearances on reasonable access roads. **Figure 6** shows the control single as it turns the standard corner.



**Figure 6: Low-Speed Off-tracking Maneuver Simulates an Intersection**

Sample data from this maneuver is in **Figure 7**. The curves show the off-tracking of the drive and trailer axles of the control single as it drives through the bend. Both drive axles exhibit essentially the same off-tracking in this low-speed maneuver, as do the two trailer axles. The off-tracking begins at zero when the tractor is on the straight path leading to the curve. It reaches a peak in the curve, with the drive axles approximately 50 in. to the inside of the steer axle's path and the trailer axles 244 in. from the steer axle's path. Off-tracking returns to zero when the vehicle is again in a straight path. The 244-in. value is reported in **Table 25**. Graphs of the data for all vehicles, for every maneuver, are in **Appendix E**.



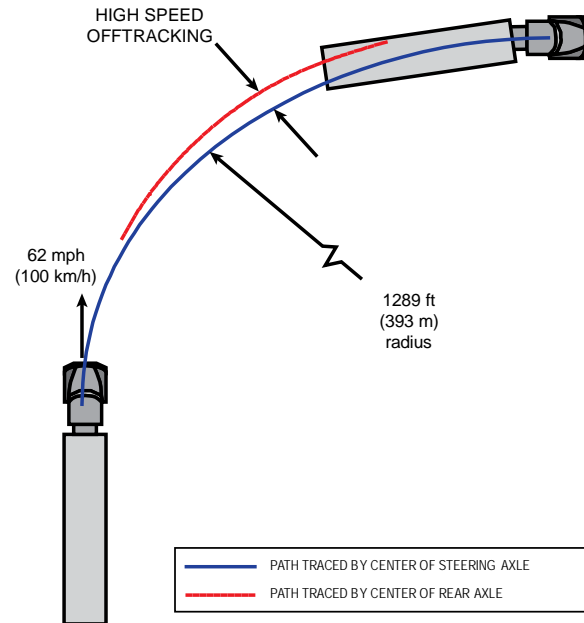
**Figure 7: Off-tracking of the Drive and Trailer Axles Rises and Falls During the Maneuver.**

**Table 25** lists the results of the low-speed off-tracking maneuver for the eight vehicles. The off-tracking values for control single and Scenario 1 are the same. At low speeds the off-tracking depends mostly on the vehicle geometry and tire properties; inertial forces make little difference. Similarly, Scenarios 2 and 3 have the same off-tracking. The trailers with three axles (e.g., Scenario 2 and 3 vehicles) off-track less than those with two trailer axles because the third set of tires helps to steer the trailer in a straight line so the trailer has less propensity to “cut” the corner. Shorter trailers off-track less than longer trailers in low-speed maneuvering, so the control double configuration has less off-tracking than the control single. For this same reason, the 33-ft trailers in Scenario 4 have more off-tracking than the 28-ft trailers in the control double. The third trailer in Scenarios 5 and 6 off-tracks more than the second trailer in the control double configuration.

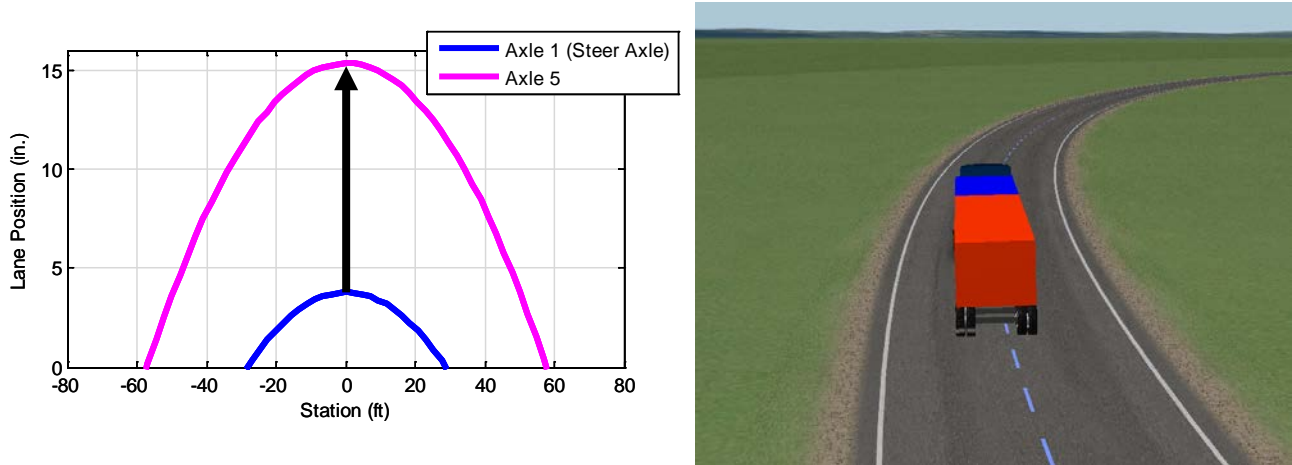
***Maneuver 2. High-Speed Off-tracking***

This maneuver is illustrated in **Figure 8**. The tractor is attempting to follow the dotted line in the center of the pavement. The rear axle of the trailer can be seen displaced toward the outside of the curve. A graph of sample data from the control single vehicle is in **Figure 9**. The blue curve indicates the path of the steer axle centerline. The red curve, which is outside of the blue curve, is the path of the fifth axle. The distance between these two curves, indicated by the arrow in the figure, is the off-tracking.

Low-speed off-tracking is always to the inside of the curve. High-speed off-tracking can be to the inside or the outside. The trailer tracked to the outside of the tractor’s path in all of the cases simulated here.



**Figure 8: Trailer Tracks to the Outside of the Curve Centerline in this High-Speed Off-tracking Illustration.**



**Figure 9: Off-tracking was Calculated by Taking the Difference in the Path Followed by the First and Final Axles.**

Note how the trailer tracks to the outside of the curve centerline in the illustration.

**Table 26** lists the results of the high-speed off-tracking maneuver. The values of the four single-trailer combinations vary by barely an inch. The two triple-trailer configurations, Scenarios 5 and 6, off-track more than do the two double-trailer configurations, but all vehicles would be well within the width of a typical highway lane.

**Table 25: High-Speed Off-tracking Results**

|                       | CS        | 1  | 2  | 3  | CD        | 4  | 5  | 6  |
|-----------------------|-----------|----|----|----|-----------|----|----|----|
| Off-tracking (inches) | <b>12</b> | 13 | 12 | 13 | <b>17</b> | 19 | 25 | 26 |

CS = control single vehicle

CD = control double vehicle

Note: All values are toward the outside of the curve.

To put the off-tracking values (and the lane position values of the next two maneuvers) in context, consider a vehicle with a nominal width of 102 in. in a 12-ft-wide lane. The edge of a unit will be at the extent of the lane when the center of an axle is displaced 21 in. from the centerline of the lane. The trailer’s yaw angle and road curvature may put the rear corner of a unit over the edge line even when the displacement is less than that. Highway design guidelines call for lanes to be widened on curves to allow for inevitable off-tracking. If this curve occurred on a two-lane roadway, the lane would be widened by approximately 14 in. (AASHTO 2011, p. 3-94).

The high-speed off-tracking of a vehicle, particularly a multi-unit combination vehicle, is as much a function of trailer loading and the tire properties as it is the vehicle itself. The tires at the front of the trailer (either the tractor’s drive tires or the dolly tires) and the tires at the rear of the trailer exert forces toward the center of the curve to keep the vehicle in the curve. The mass at the unit’s center of gravity exerts the equivalent of a centrifugal force. The balance between the inward and outward forces (called understeer or oversteer characteristics) determine the angle of the unit as it rounds the curve and thence its off-tracking. The tire models have been validated through the NHTSA testing (Rao et al., 2013) to represent reasonable properties, and the center of gravity was positioned to achieve the desired axle loads; however, a change in loading or a change in tires would change the off-tracking. Furthermore, for a given vehicle and payload, the off-tracking varies with speed. In a transient situation (as in Maneuver 5), the situation is more complicated. The height of the center of gravity affects the left-right load transfer, which in turn affects the ability of the tires to generate lateral forces.

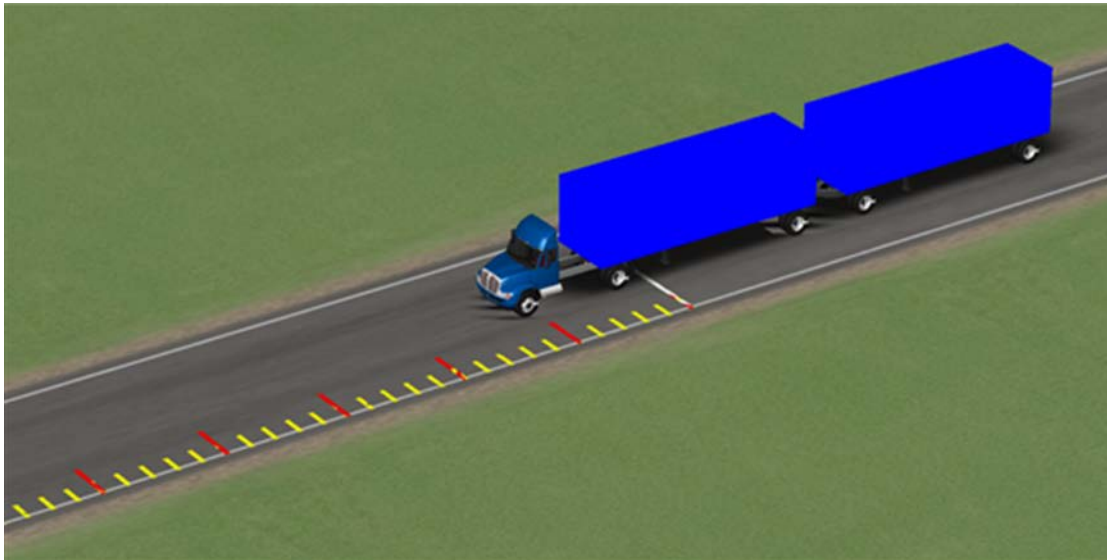
***Maneuver 3. Straight-Line Braking***

This maneuver is based the stopping distance test in S5.3.1.1 of FMVSS No. 121. The stopping distance requirement in Table II of FMVSS No. 121, for two-axle tractors and for three-axle tractors with a gross vehicle weight rating (GVWR) of 70,000 lbs. or less is 250 ft. According to the requirement, the compliance test is conducted with a tractor with an un-braked control trailer. For purposes of this simulation, the control single vehicle was modeled as a vehicle for which the stopping distance was measured with a GVW of 80,000 lb., which is consistent with the stopping distances outlined in Figure 5 of Hoover et al., 2005. The brakes for the control single

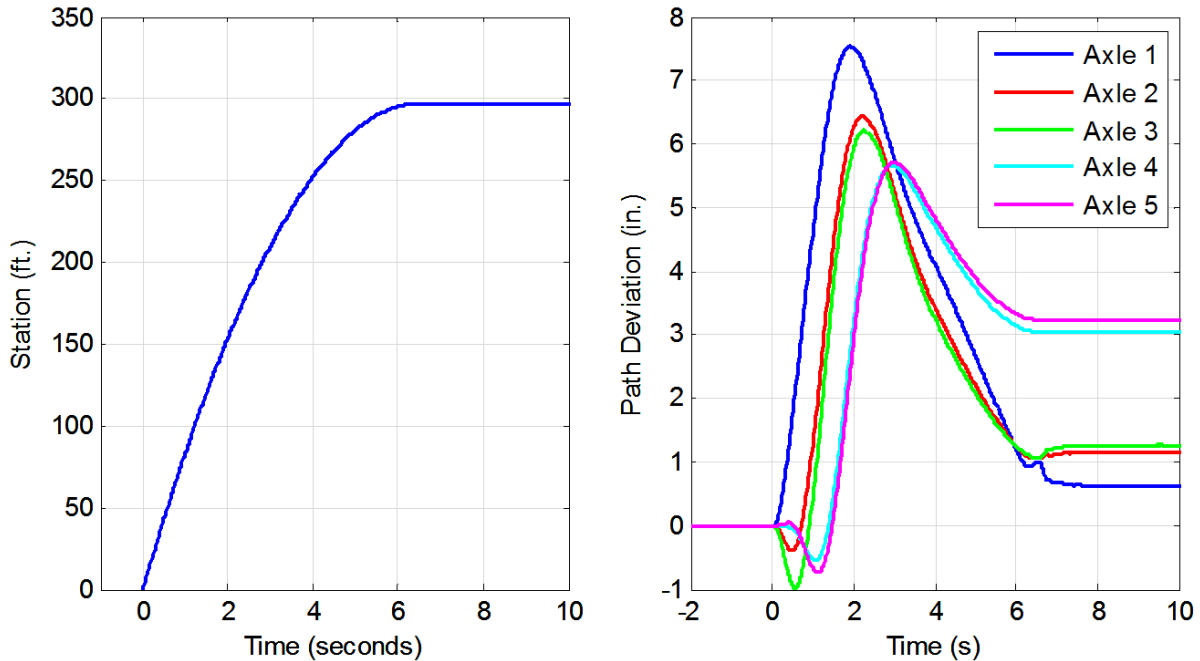
vehicle were modeled so that it stops in approximately the average distance shown in that figure as well (i.e., 240 ft.).

Other vehicles have brakes that are identical to those in the control single. The third trailer axle for Scenarios 2 and 3 has braking capability identical to those on the tandem trailer axles of Control Vehicle CS and Scenario 1. To be sure, brake equipment of better capability is commercially available, but the assumption was to leave the brakes unchanged in the models so the results would be a comparison of the change in gross weight and trailer arrangement and nothing else.

An illustration of a simulated truck beginning this maneuver is in **Figure 10**. **Figure 11** has the data from the control single simulation in the case where the right-side brakes on both drive axles are disabled. The left portion of the figure shows how its position (“station”) begins at zero when brakes are applied at time zero and comes to a stop after traveling 297 ft. The right side of the figure shows the positions of the axles as a function of time. The vehicle pulls to the left (positive direction) when the brakes are applied, but the driver can steer it back to the lane center as it slows. The peak deviation of an axle center from the intended path was 8 in. The results for all vehicles are in **Table 27**.



**Figure 10: Simulation of the Straight-line Braking Maneuver**



**Figure 11: Position vs. Time (left) and Path Deviation vs. Time (right) of Control Single Vehicle as it Stops with Brake Failure on the Right Ends of the Two Drive Axles**

**Table 26: Straight-Line Braking Results**

| Quantity                      | Brake Condition | CS  | 1   | 2   | 3   | CD  | 4   | 5   | 6   |
|-------------------------------|-----------------|-----|-----|-----|-----|-----|-----|-----|-----|
| Stopping Distance (ft.)       | Normal          | 235 | 255 | 234 | 247 | 230 | 252 | 247 | 239 |
|                               | ABS malfunction | 235 | 255 | 234 | 247 | 230 | 252 | 247 | 239 |
|                               | Brake Failure   | 297 | 323 | 286 | 301 | 249 | 272 | 262 | 249 |
| Maximum Path Deviation, (in.) | Normal          | 0   | 0   | 0   | 0   | 0   | 0   | 0   | 0   |
|                               | ABS malfunction | 0   | 0   | 0   | 0   | 0   | 0   | 0   | 0   |
|                               | Brake Failure   | 8   | 8   | 7   | 8   | 5   | 5   | 8   | 5   |

CS = control single vehicle  
 CD = control double vehicle

The control single vehicle stops in 235 ft. By contrast, Scenario 1, with a slightly higher weight on the same brakes, has a stopping distance that is longer. The addition of the trailer axle in Scenario 2, with its additional brakes, slightly reduces the stopping distance despite the additional weight. The higher weight of Scenario 3 also lengthens the distance—by about 5 percent over the distance of the control single vehicle.

The stopping behavior of the multi-trailer combinations also is different from that of the single-trailer combinations. This is because when a vehicle brakes hard, the body pitches forward and transfers load from the rear tires to the front, and the results of this behavior depend on the height of the payload, the suspension properties, and the length of the trailer.

The brake failure has a greater effect on the two five-axle combinations (control single and Scenario 1) than the six-axle combinations (Scenarios 2 and 3) because more brakes remain intact in the combinations with more axles. The effect of the brake failure is also less on the multi-trailer combinations, where two axle ends suffer failure, than the single-trailer combinations, with one axle end failure.

The ABS malfunction does not affect the straight-line stopping distance because the ABS is not engaged by the dry pavement stop in this simulation.

FMCSA has recently conducted testing to investigate the straight-line stopping distances of five- and six-axle combinations of a tractor and flatbed semitrailers at various weights and brake failure scenarios (Lascurain et al., 2013 and 2014). The vehicles in those experiments differ from the configurations modeled in the present study in several respects. Most notably, the semitrailers in those studies were 48-ft. flatbeds, not 53-ft. dry-vans. Those measurements cannot be used to verify the present simulations, but comparisons can be drawn. Further details on the testing conducted by FMCSA can be found in the section that follows.

The stopping distances of both the simulated and experimental 80,000-lb. vehicles with fully functioning brakes differ by 11 ft. because both were intended to meet the FMVSS No. 121 stopping distance requirement. When two drive axle brakes were disabled, the simulated vehicle's stopping distance increased 26 percent and that of the experimental vehicles by 38 percent. Again, when two drive axle brakes were disabled on a 97,000-lb. six-axle vehicle, the stopping distance increased in the simulation by 22 percent and in the experiment by 32 percent. Either study's results can be considered a reasonable value for its conditions.

The lane deviation in **Table 27** for the first two braking conditions is exactly zero because the idealized computer model does not cause the vehicle to deviate to the right or left. A real truck would inevitably have some asymmetry, producing some deviation. The third braking condition, brake failure on the same side of both drive axles or on the one side of the first dolly, does produce a yaw moment. The vehicle moves a few inches from the lane center in the simulation, which is consistent with experience.

### **FMCSA/ORNL Tractor-Semitrailer Brake Testing**

This testing was led by FMCSA in coordination with FHWA and with the support of ORNL. The tests were performed on a combination vehicle with larger tractor brakes meeting the reduced stopping distance (RSD) requirement reflected in FMVSS 121 (49 CFR Part 571). The RSD tractor configuration uses larger front drum brakes to meet the NHTSA FMVSS 121 air brake testing upgrade, which went into effect in 2011 for three-axle tractors.



### Five-Axle Tractor-Semitrailer Testing

The first set of tests involved a five-axle combination vehicle fitted with brakes meeting the RSD requirement. Following a complete brake rebuild, instrumentation, and brake burnish, the study team conducted stopping tests for various brake conditions at 60,000, 80,000, 91,000, 97,000, 106,000, and 116,000 lbs. GVW. The 80,000-lb. GVW tests included both balanced (load equally distributed on trailer) and unbalanced (loading of trailer biased towards front of trailer) loads. The condition of the braking system was also varied from fully operational to induced braking defects. To introduce these defects, the brakes were alternately deactivated on the forward drive axle of the tractor and the rear trailer axle. In addition to the stopping tests, performance-based brake tests were conducted for the various loading and brake conditions on a brake roller dynamometer.

Analysis of the stopping test data showed that the stopping distance generally increases with load and also showed that more braking force was generated by the drive axle brakes than the trailer axle brakes.

**Table 27: Five-axle Tractor-Semitrailer (Flat-bed) – Stopping Distances at 60 mph**

| Gross Vehicle Weight    | Full Brakes | Disabled Drive Axle | Disabled Trailer Axle |
|-------------------------|-------------|---------------------|-----------------------|
| 60,000 lbs              | 228 feet    | 299 feet            | 229 feet              |
| 80,000 lbs (balanced)   | 223 feet    | 309 feet            | 256 feet              |
| 80,000 lbs (unbalanced) | 223 feet    | 320 feet            | 246 feet              |
| 91,000 lbs              | 225 feet    | 310 feet            | 272 feet              |
| 97,000 lbs              | 238 feet    | 328 feet            | Not done              |
| 106,000 lbs             | 240 feet    | 326 feet            | 294 feet              |
| 116,000 lbs             | 252 feet    | 340 feet            | 319 feet              |

### Six-Axle Tractor-Semitrailer Testing

The first part of the six-axle testing was conducted in 2013 and involved a combination vehicle equipped with RSD brakes on the steer axle of the tractor. Similar to the five-axle research vehicle, tests for this phase of the research effort included Performance Based Brake Tests (PBBT), and full effectiveness stops. The condition of the braking system was also varied from fully operation to induced braking defects. To introduce these defects, the study team alternately deactivated the brakes on the forward drive axle and the rear trailer axle. In addition to the stopping tests, performance-based brake tests were conducted for the various loading and brake conditions on a brake roller dynamometer.

FMVSS 121 stopping distance test protocols were followed and additional induced brake defect stopping distance tests were performed. The six-axle test weights were conducted for various brake conditions at 80,000, 88,000, 97,000 (balanced), 97,000 (unbalanced) 112,000, and 132,000 lbs. GVW.

ORNL gathered the required stopping distance data and analyzed it to provide background information regarding the braking capability of air-braked commercial combination vehicles operating at maximum weight allowed by FHWA Bridge Formula and in heavy weight conditions under various levels of brake performance. This testing was conducted on a vehicle

with larger tractor brakes meeting the RSD requirement rulemaking reflected in FMVSS-121 (49 CFR Part 571). A similar set of tests were repeated on the same vehicle fitted instead with non-RSD brakes on tractor steer axle.

**Table 28: Six-axle Tractor-Semitrailer (flat-bed) Stopping Distances at 60 mph (RSD Tractor – Large Front Brakes)**

| Gross Vehicle Weight    | Full Brakes | Disabled Drive Axle | Disabled Trailer Axle |
|-------------------------|-------------|---------------------|-----------------------|
| 80,000 lbs              | 218 feet    | 289 feet            | 272 feet              |
| 88,000 lbs              | 216 feet    | 273 feet            | 290 feet              |
| 97,000 lbs              | 221 feet    | 292 feet            | 274 feet              |
| 97,000 lbs (unbalanced) | 215 feet    | 292 feet            | 274 feet              |
| 112,000 lbs             | 234 feet    | 311 feet            | 283 feet              |
| 132,000 lbs             | 269 feet    | 363 feet            | 334 feet              |

**Table 29: Six-axle Tractor-Semitrailer (flatbed) – Stopping Distance at 60 mph (Non-RSD Tractor – Small Front Brakes)**

| Gross Vehicle Weight | Full Brakes | Disabled Drive Axle | Disabled Trailer Axle |
|----------------------|-------------|---------------------|-----------------------|
| 80,000 lbs           | 257 feet    | 333 feet            | 306 feet              |
| 88,000 lbs           | 249 feet    | 315 feet            | 305 feet              |
| 97,000 lbs           | 262 feet    | 338 feet            | 298 feet              |
| 97,000 (unbalanced)  | 251 feet    | 333 feet            | 299 feet              |
| 112,000 lbs          | 250 feet    | 343 feet            | 300 feet              |
| 132,000 lbs          | 299 feet    | 409 feet            | 347 feet              |

**Maneuver 4. Brake-in-a-Curve**

This maneuver is based on the brake-in-a-curve test in S5.3.6.1 of FMVSS No. 121. The curve radius is 500 ft. This full-treadle brake application on a slippery surface is intended to evaluate the performance of ABS, which is currently required on all heavy vehicles with a GVWR over 10,000 lbs. The brake models in this maneuver are identical to those in the straight-line braking maneuver.

**Table 30** provides the results for this maneuver. The path deviation for the cases with the normal brake system was mostly due to steady-state off-tracking; the deviation increased marginally when the brakes were applied. However, the single-trailer cases with a simulated ABS malfunction all jackknifed, as illustrated in **Figure 12**.

None of the multi-trailer configurations jackknifed when the ABS malfunction was applied to the lead dolly, although three of them experienced a path deviation of approximately 36 in. Scenario 4, with two 33-ft. trailers, had a minor path deviation. That is not because the configuration is

significantly more stable than the other vehicles, but rather because it is near a threshold of instability in the study’s assumptions. If the coefficient of friction in the model road is lowered from 0.5 to 0.46, Scenario 4 will deviate significantly from the path. The reason for the different behavior is a combination of factors, including load and length.

Complete failure of the designated brakes increases the path deviation by a few inches.

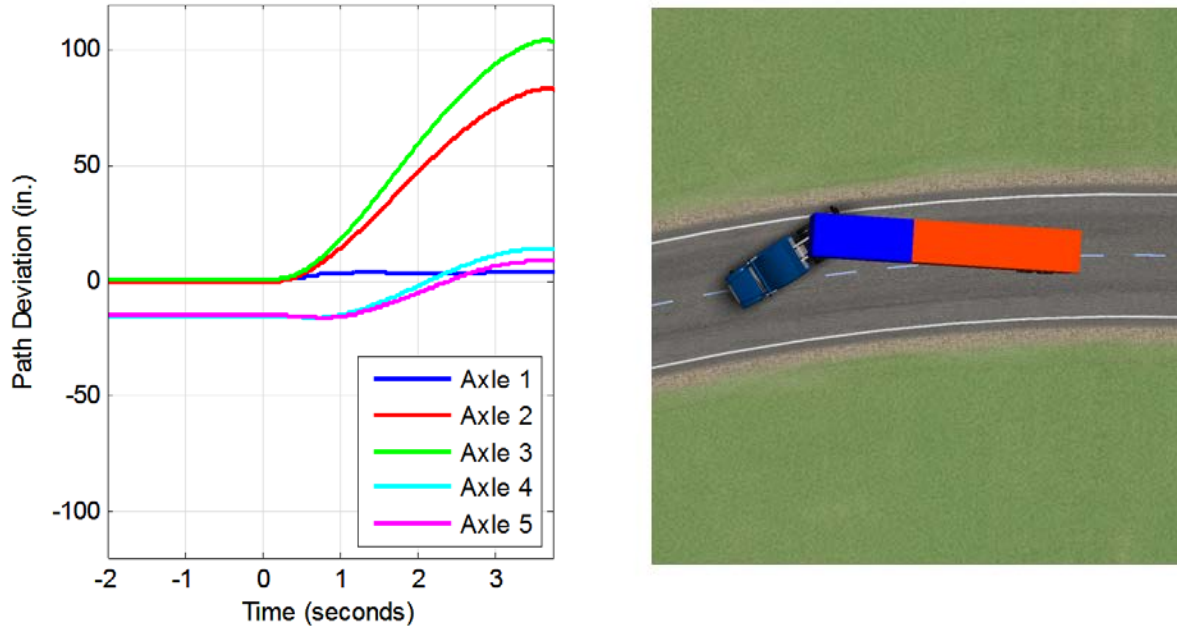
**Table 30: Brake-in-a-Curve Results**

| Quantity                     | Brake Condition              | CS          | 1    | 2    | 3    | CD          | 4    | 5    | 6    |
|------------------------------|------------------------------|-------------|------|------|------|-------------|------|------|------|
| Stopping Distance (ft.)      | Normal                       | <b>85</b>   | 88   | 84   | 86   | <b>86</b>   | 88   | 88   | 86   |
|                              | ABS Malfunction <sup>a</sup> | -           | -    | -    | -    | <b>86</b>   | 89   | 87   | 86   |
|                              | Brake Failure                | <b>107</b>  | 111  | 103  | 105  | <b>96</b>   | 98   | 95   | 92   |
| Maximum Path Deviation (in.) | Normal                       | <b>19</b>   | 19   | 17   | 17   | <b>4</b>    | 7    | 5    | 5    |
|                              | ABS Malfunction              | <b>104</b>  | 112  | 102  | 106  | <b>36</b>   | 7    | 35   | 35   |
|                              | Brake Failure                | <b>21</b>   | 22   | 20   | 20   | <b>10</b>   | 12   | 11   | 8    |
| Lateral Load Transfer Ratio  | Normal                       | <b>0.34</b> | 0.37 | 0.34 | 0.37 | <b>0.44</b> | 0.42 | 0.44 | 0.44 |
|                              | ABS Malfunction              | <b>0.34</b> | 0.37 | 0.34 | 0.37 | <b>0.44</b> | 0.42 | 0.44 | 0.44 |
|                              | Brake Failure                | <b>0.34</b> | 0.37 | 0.34 | 0.37 | <b>0.44</b> | 0.43 | 0.44 | 0.44 |

<sup>a</sup> Stopping distance is not reported for the four cases that jackknifed in this maneuver.

CS = control single vehicle

CD = control double vehicle



**Figure 12: A Bird's Eye View of Control Vehicle CS after Coming to Rest in the Brake-in-a-curve Maneuver with the ABS Disabled on the Drive Axles**

The stopping distance is reported for all cases in which the vehicle did not jackknife. FMVSS No. 121 does not have a stopping distance requirement for this test, and the distances are not meaningful for the jackknifed cases. The failed brake does extend the stopping distance of a particular vehicle, but the variations between vehicles are less than 10 ft. and are not significant.

The lateral load transfer has a steady state value while the vehicle is at a steady speed in the curve. The quantity begins to decrease when the brakes are applied, but some cases had a minor transient as the brakes were applied.

***Maneuver 5. Avoidance Maneuver***

The procedure to evaluate rearward amplification properties was based on the single lane change maneuver in ISO 14791 (ISO 2000).

All avoidance maneuvers were run at 50 mph. Eight paths were drawn, each in the shape of a single lane change but with a different amount of lateral path change. For each path, the longitudinal distance of the transition was set so that, if the tractor exactly followed the path, its lateral acceleration would be a single cycle of a sine wave with a peak lateral acceleration of 0.15 gravitational units. How much the trailers responded to the steering would depend on how sudden the maneuver was (technically, the frequency of excitation). Eight lane change widths (3, 6, 9, 12, 15, 18, 21, and 24 ft.) were simulated for the avoidance maneuvers. Given these eight lane changes, the highest response (i.e. highest off-tracking, highest rearward amplification, and highest lateral load transfer ratio) for each vehicle is reported in **Table 31**. A formal mathematical explanation of the maneuver and analysis is in **Appendix C**.

**Table 31: Avoidance Maneuver Results**

|  | CS          | 1    | 2    | 3    | CD          | 4    | 5    | 6    |
|--|-------------|------|------|------|-------------|------|------|------|
| Peak Off-tracking (in.)                        | <b>3.9</b>  | 4.3  | 3.9  | 4.4  | <b>23.2</b> | 21.7 | 43.8 | 44.5 |
| Rearward Amplification of Lateral Acceleration | <b>1.0</b>  | 1.0  | 1.0  | 1.0  | <b>2.1</b>  | 2.3  | 2.1  | 2.3  |
| Lateral Load Transfer Ratio                    | <b>0.42</b> | 0.44 | 0.49 | 0.46 | <b>0.93</b> | 0.84 | 1.00 | 1.00 |

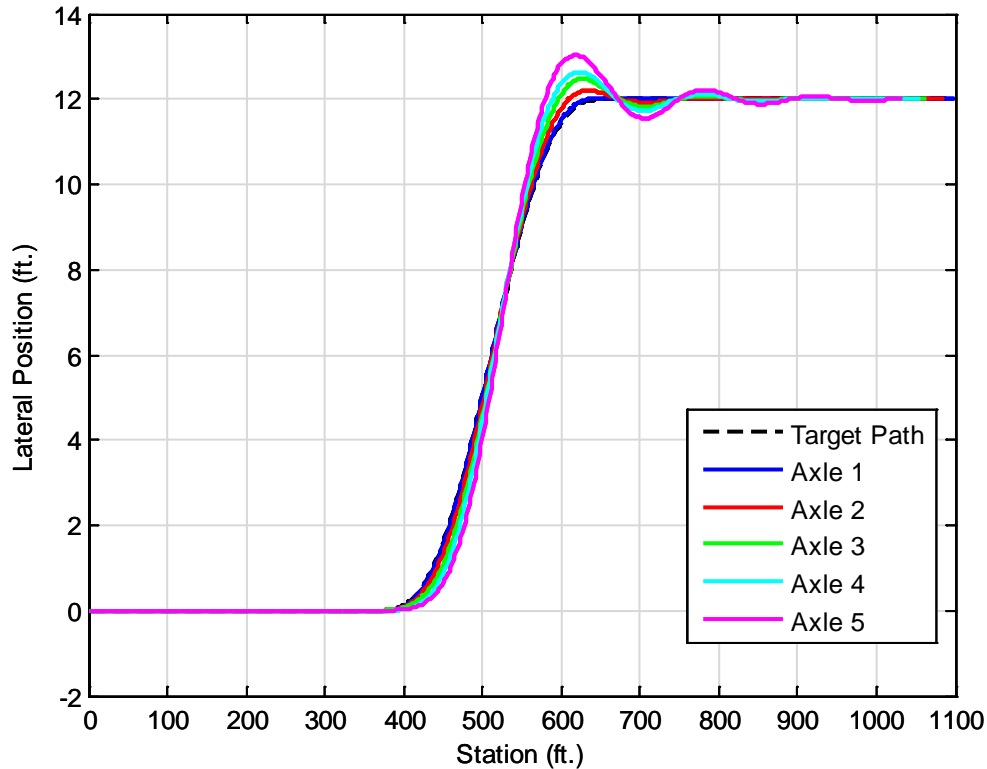
CS = control single vehicle  
 CD = control double vehicle

The path of the 12-ft lane change for control double is illustrated in **Figure 13**. The figure shows how the tractor steer axle is attempting to follow the target path. The steer axle followed the path quite well, staying within 2 in. in all cases; the peak lateral acceleration of the tractor center of gravity ranged from 0.14 to 0.19 gravitational units from case to case.

**Figure 13** shows that, while the steer axle follows the intended path quite well, the drive and trailer axles lag behind during the main part of the maneuver and overshoot at the conclusion of the maneuver. **Figure 14** shows the difference between the paths of axles 2 through 5 and the steer axle at each point along the roadway. This difference is the transient off-tracking. The off-tracking begins at zero when the tractor is on the straight path before the maneuver and reaches its peak as the lane change is ending, when the rear axle on the second trailer was 16 in. beyond the path of the steer axle. Off-tracking returns to zero when the vehicle is again in a straight path.

**Figure 15** is a graph of the lateral acceleration time history for this same maneuver. Markers in the figure indicate the peaks in the lateral acceleration of Trailer 2 and of the tractor. The rearward amplification is the ratio of these two quantities. Rearward amplification results for this maneuver are in **Table 29**. The trailer of all single-trailer combinations followed the tractor's path almost exactly at low rates, and the ratio is reported as unity in the table. Trailer motion was less at the more abrupt lane changes. For each of the four multi-trailer configurations, there was at least one lane change distance where the rearward amplification was greater than unity, as in **Figure 14**.

**Figure 16** plots the vertical forces on the tires for this same case. (These are forces on the axle end. The steer tires have the forces plotted; other axles have dual tires so the force on each tire is half of the value.) Vertical tire forces remained positive throughout the duration of the lane change maneuver, meaning that no wheels lifted off the pavement. Markers in the figure indicate the moment where the maximum amount of load was transferred from the right side to the left side of the rear axle. Lateral load transfer ratio in this case is  $(12,683-2,049)/(12,683+2,049)$  or 0.72. A value of 0.94 is reported for the control double in **Table 29** because the load transfer was greater in the 6-ft. lane change.

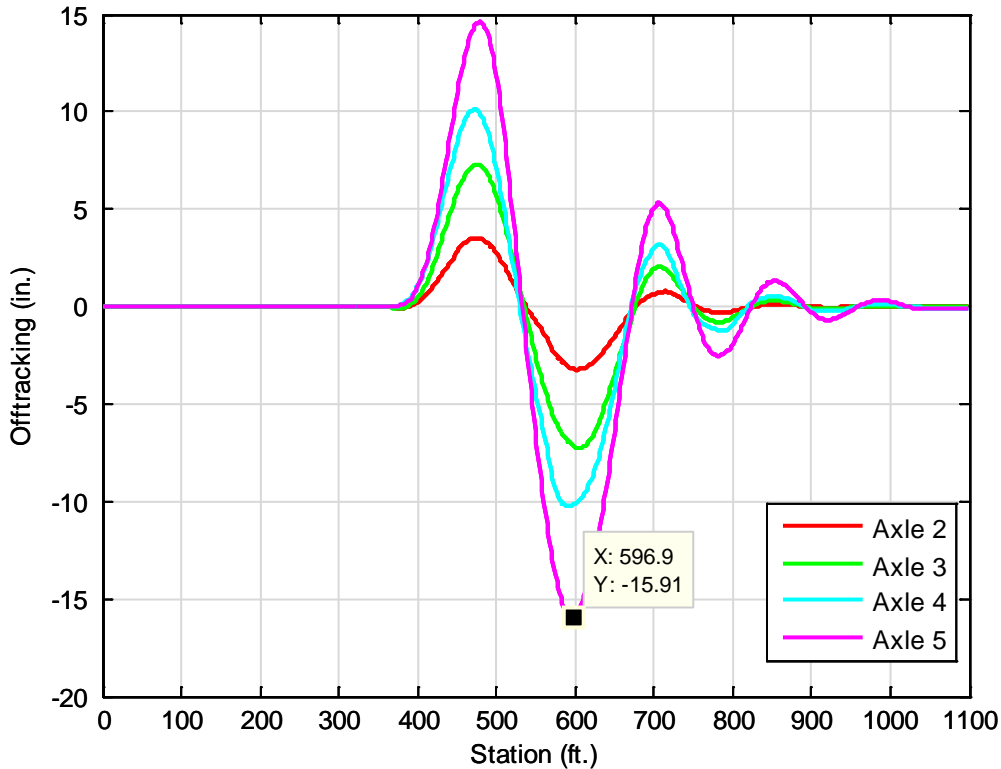


**Figure 13: Paths of the Axle centerlines of the Control Double as it Executes the 12-ft. Avoidance Maneuver**

The differences between the results for the four single-trailer combinations are not significant. Off-tracking is minimal for all scenarios. The load transfer across the trailer axles is nearly the same for the three scenario vehicles as for the control vehicle, and momentary load transfers at this level will not roll over a trailer.

As expected, the responses for the multi-trailer combinations to this maneuver were more significant. With the exception of the off-tracking of the three-trailer combinations, the differences in dynamic responses between the four multi-trailer combinations are not meaningful. A sensitivity study with more conditions would yield variations in results and the order of the vehicles' performance.

Load transfer ratios for all four multi-trailer combinations were high, and all would be in danger of rolling over if a maneuver of this severity were performed on an actual vehicle. Scenarios 5 and 6 had a lateral load transfer of 1.00. This means that the load on one end of the axle on the third trailer was completely removed for periods of less than one second, but the trailer did not roll over in the simulation. Although not advisable in service, it is possible on a test track to briefly lift one trailer axle without rolling the trailer over. The load transfer ratio of 1.0 is slightly higher than the 0.94 for the control vehicle. This illustrates why drivers of multi-trailer combinations are trained to avoid sudden steering maneuvers.



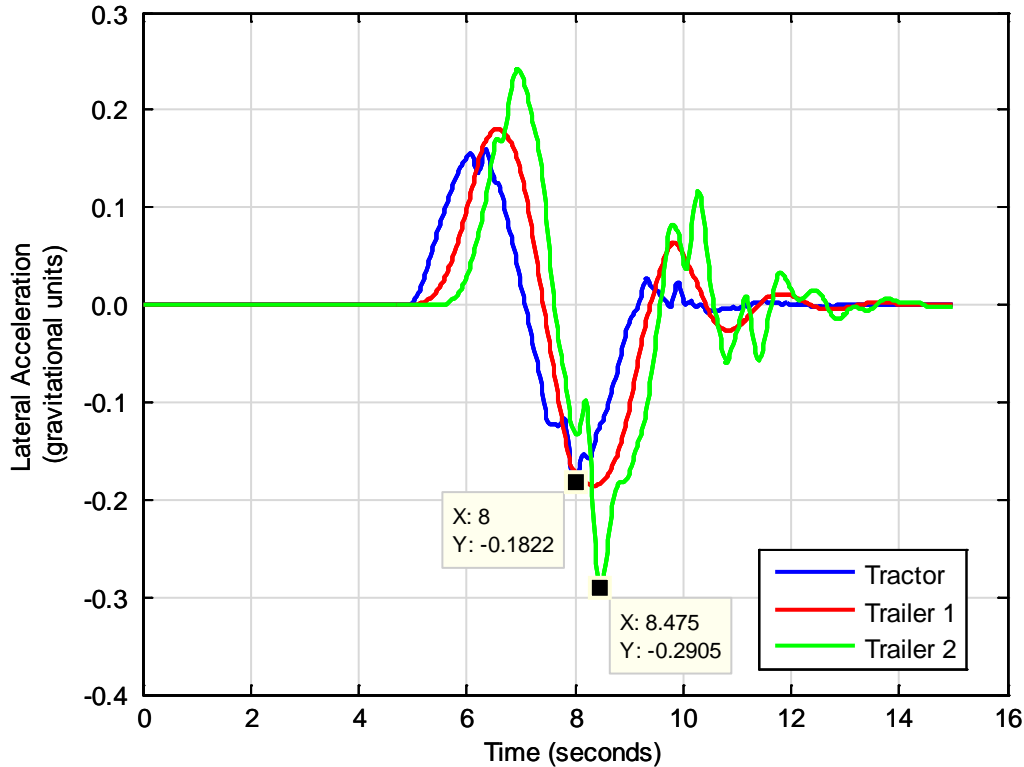
**Figure 14: Off-tracking was Computed from the Axle Paths in the Previous Figure<sup>3</sup>**

### **3.4 Conclusions**

The simulations and field test results generally agreed with trends that could be expected for the nature of the modifications to the two control vehicles. The simulations quantified the changes in performance as the size or weight of the vehicles was increased.

None of the maneuvers identified a condition where the stability of a single-trailer combination was severely impaired by the addition of payload weight or a third trailer axle. Low- and high-speed off-tracking results were changed by amounts that would be difficult to measure in practice. Adding weight to the payload increased the stopping distance on dry road by less than 10 percent; in the proportions selected for the study, the additional brakes on the third trailer axle compensated for the additional payload in Scenario 2. Simulating a complete right-side brake failure on both drive axles increased the stopping distance, and the effect of that failure on the alternative configuration vehicles was similar to its effect on the control vehicle. The ABS malfunction caused a jackknife on all single-trailer combinations as expected; its severity did not appreciably differ between scenarios. All four single-trailer combinations had a benign response to the avoidance maneuver.

<sup>3</sup> At each station down the road, off-tracking is the distance between the steer axle’s lateral position and the following axle’s position when it reached that station.

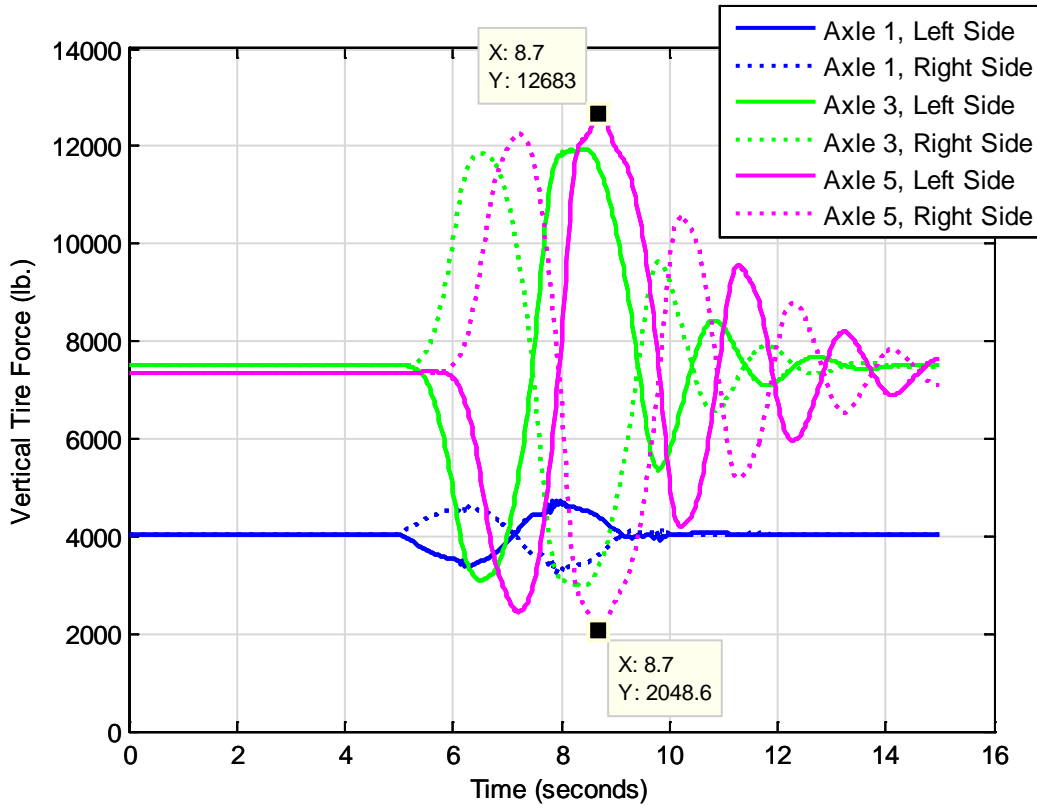


**Figure 15: Lateral Acceleration Time Histories of the Three Units of Control Vehicle CD in the 12-ft Lane Change.<sup>4</sup>**

Multi-trailer combinations were most challenged by the avoidance maneuver, which was formulated for that purpose. The final trailer in all four vehicles traced a wider path, experienced greater lateral acceleration, and put more load on the outside tires than did the tractor. The severity of the maneuver caused amplification of the second trailer's response compared to the tractor's response in the two-trailer combinations. The greater length of the 33-ft. trailers in Scenario 4 lowered the response slightly below that of the control vehicle with 28-ft. trailers. The amplification of the third trailer's response in Scenarios 5 and 6 was greater than that of the second trailer in the control vehicle, as would be expected. Differences between the multi-trailer combinations in the off-tracking and braking maneuvers were present but not as significant. Under the assumptions of the study, the Scenario 4 alternative configuration had a higher average axle load than the other combinations and had a marginally higher stopping distance. When the ABS on the lead dolly malfunctioned during the brake in a turn, all 28-ft. combinations experienced a path deviation of 35 in., which was short of a jackknife but would violate a 12-ft. lane. The 33-ft. combination of Scenario 4 was on the verge of instability, but its path deviation was not affected by the ABS malfunction under the specific conditions of this study.

<sup>4</sup> Note that the trailers experience more acceleration than does the tractor.





**Figure 16: Vertical Tire Forces during the Lane Change Maneuver for the 12-ft Lane Change for Control Vehicle CD<sup>5</sup>**

The high-speed off-tracking of the three-trailer combinations was 8 to 9 in. greater than the control vehicle but still well within the width of a highway lane for that speed and curvature. All three multi-trailer study vehicles had a low-speed off-tracking roughly one third higher than did the control double.

These results quantify the effects of these specific changes to truck size and weight in the limited set of maneuvers studied here. The maneuvers were selected because they follow recognized vehicle dynamic performance standards or were used in previous studies. The results are representative of the respective vehicles' behavior, but they would be different if similar maneuvers of different curvature or speed were selected.

<sup>5</sup> The vehicle leans to one side and then the other as it executes the avoidance maneuver. This removes load from tires on one end of each axle and transfers it to the other end.

## CHAPTER 4 - INSPECTION AND VIOLATION ANALYSIS

### 4.1 Overview

The goal of this analysis is to understand the implications of increased size and weight on motor carrier inspection violations, out-of-service violations, and citations. A violation can be discovered during the inspection, and some violations may place the vehicle out-of-service (OOS) or be issued a citation. MAP-21 Section 32801 requires a comparative analysis to be conducted to examine “vehicles that operate with size and weight limits in excess of the Federal law regulations, or that operate under a Federal exemption or grandfathered right, in comparison to vehicles that do not operate in excess of Federal laws and regulations (other than vehicles with exemptions or grandfathered rights).” For more information on the findings of that analysis, please see *Volume II: Compliance Comparative Analysis*.

The purpose of the study team’s review of safety inspections and violations was to identify the potential impact of increased gross combined vehicle weight (GCVW)<sup>6</sup> on the overall level of violations-related actions as a result of inspections. Level 1 inspection, an inspection of driver and vehicle, data extracted from the 2008 to 2012 MCMIS Inspection Data were used for the analysis.

The analysis included 14 States with heavy semitrailer configurations (Alaska, Idaho, Kentucky, Maine, Michigan, Nevada, New Hampshire, New York, North Dakota, Oregon, Utah, Vermont, Washington and Wyoming) and 10 States with triple-trailer configurations (Colorado, Idaho, Kansas, Montana, Nevada, North Dakota, Oklahoma, Oregon, South Dakota and Utah). Ohio was not included in either analysis as the unit data did not match the inspection data extracted from MCMIS. Ten States allowing the operation of triple-trailer configurations were explored to assess the violation-related issues with this configuration. Unfortunately, the search of the 10 State inspection files over 5 years yielded only 73 Level 1 inspections, making the sample size insufficient for any additional statistical modeling. Selective tables are presented summarizing these data.

The analysis of tractor semitrailers in Scenarios 1, 2, and 3 was based on specific tractor semitrailer configurations that were **legally operated** (that is, there were no overweight violations). Analyses comparing triple trailers with twin-trailer configurations included all triple-trailer configurations over 80,000 lbs. and legally operated tractor twin-trailer configurations at 80,000 lbs. There were limited data available for triple-trailer configurations in MCMIS; thus the distinction between overweight and not overweight was not made for this configuration.

The vehicle was identified as overweight if it had received an **overweight violation** during the inspection. That is, a CMV with any type of overweight violation (e.g. exceeding axle weight limits) was regarded as illegally operated.

---

<sup>6</sup> The term gross combined vehicle weight (GCVW) is used here so that it is consistent with the description used in MCMIS, which is the primary data source used in this section and described in Section 4.4.

## **4.2 Objectives**

The objective of this portion of the study is to identify any relationships between the patterns of violation, out-of-service actions and citations, and truck configuration, especially configurations operating legally. Due to limitations in MCMIS data (no information on number of axles or length of units), truck configurations had to be separated based on their unit type (i.e. tractor) and GVW. Using this method, a tractor semitrailer weighing 88,000 lbs. can be considered a legally operated 88,000-lb. tractor semitrailer, but it can also be an illegally operated 80,000-lb. tractor semitrailer. Hence, we cannot distinguish a legally operated tractor semitrailer weighing 88,000 lbs. from an illegally operated overweight 80,000-lb. semitrailer. Thus, “legally operated” CMVs were selected to eliminate trucks with overweight violations (i.e., illegal) from our analyses. This study objective ties directly to basic inspection data collected by FMCSA and part of their MCMIS database and seeks the answers to 4 questions:

1. How does the pattern of inspections differ across the baseline and candidate vehicle configurations?
2. How do violations differ with configuration?
3. How do out-of-service outcomes differ with configuration?
4. How do citations differ with configuration?

## **4.3 Methodology**

The USDOT study team used a series of tables and statistical models to explore the nature of the relationships regarding truck configurations and roadside safety inspection data. Exploratory cross tabulations show initial trends and patterns. Logit models are then developed to predict the likelihood of a discrete outcome as a function of predictor variables. The outcomes are, in this case, “yes” or “no” categories that help provide answers to bullet items 2-4 above (bullet 1 is answered through the use of cross-tabulations).

## **4.4 Data Used in Inspection and Violations Analysis**

### ***MCMIS Inspection File Data***

For the years 2008 to 2012, the number of inspections, violations, and citations by truck configuration and year is shown in **Table 32**. The number of inspections includes all Level 1 data available in MCMIS for the 5 years. (See **Appendix G** for a description of the three levels of inspections to which a driver or vehicle may be subjected.) The violations include all safety violations as well as out-of-service and some moving violations as well. The citations shown do not include overweight violations, except as noted in selected tables.

The truck configurations examined in this study were limited to those available within the MCMIS inspection file. Each inspection included information about the type and number of vehicle units as well as the gross vehicle weight. Note that the gross combined vehicle weight (GROSS\_COMB\_VEH\_WT) field is filled in by the field inspector and may include the gross vehicle manufacturers’ weight rating, the weight of the load per the bill-of-lading, or an actual measured weight if the truck was weighed at time of inspection. For the period 2008 to 2012, 82 percent of the data in MCMIS includes data in this field.

**Table 32: Summary of MCMIS Data From All 19 Study States for 2008 to 2012**

| Year  | Semitrailers |     |     |     | Twin Trailers | Triple-Trailers |
|---|--------------|-----|-----|-----|---------------|-----------------|
|   | 80K          | 88K | 91K | 97K | 80K           | >80K            |
| <b>Number of inspections</b>  |              |     |     |     |               |                 |
| 2008  | 20267        | 278 | 601 | 481 | 220           | 6               |
| 2009  | 20456        | 312 | 647 | 544 | 214           | 14              |
| 2010  | 15459        | 344 | 555 | 459 | 214           | 9               |
| 2011  | 12523        | 285 | 484 | 553 | 138           | 12              |
| 2012  | 12066        | 289 | 474 | 541 | 79            | 11              |
| <b>Number of violations (w overweight)</b>                                |              |     |     |     |               |                 |
| 2008  | 16116        | 232 | 464 | 399 | 184           | 4               |
| 2009  | 16503        | 252 | 546 | 456 | 176           | 10              |
| 2010  | 12329        | 289 | 458 | 404 | 180           | 4               |
| 2011  | 9456         | 221 | 371 | 429 | 112           | 10              |
| 2012  | 9169         | 235 | 381 | 450 | 56            | 10              |
| <b>Number of OOS violations (with OOS noted for overweight violation)</b> |              |     |     |     |               |                 |
| 2008  | 6842         | 95  | 200 | 188 | 68            | 2               |
| 2009  | 6674         | 96  | 232 | 212 | 81            | 3               |
| 2010  | 4959         | 110 | 173 | 177 | 96            | 0               |
| 2011  | 4149         | 86  | 157 | 190 | 52            | 3               |
| 2012  | 4155         | 109 | 160 | 221 | 28            | 1               |
| <b>Number of citations</b>  |              |     |     |     |               |                 |
| 2008  | 4216         | 40  | 119 | 121 | 46            | 0               |
| 2009  | 4189         | 63  | 163 | 113 | 49            | 0               |
| 2010  | 3560         | 65  | 136 | 130 | 64            | 0               |
| 2011  | 2819         | 55  | 96  | 108 | 28            | 1               |
| 2012  | 2542         | 50  | 89  | 132 | 19            | 0               |

K = 1,000 lbs.


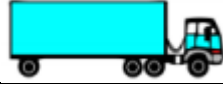
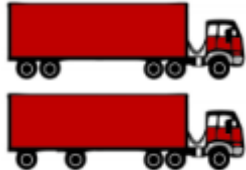

OOS = out of service

In order to include configuration inspections around the target weights used in this study (e.g., 88,000 lbs.) it was reasonable to allow a weight tolerance around the target value. For tractor semitrailers, inspections were included with a variation around a specific target weight of +/- 1,000 lbs.; for twin trailer/triple-trailer configurations, the tolerance is +/- 6 percent of the target weight. This only affects the inspections included in the study; most analyses use a rate per inspection as a dependent variable.

Tractor semitrailers were identified by their configuration of one tractor and one semitrailer. There were five possible tractor semitrailer combinations with number of axles ranging from 3 to 6 and gross weight limits equal to 60,000 lbs. or 80,000 lbs. per the Bridge Formula (see **Figure 17**). The Bridge Formula is used to calculate the allowable weight of a truck. It is based on the

weight-to-length ratio of a vehicle crossing a bridge (FHWA-HOP-06-105). It should be noted that the Bridge Formula could not be used for individual trucks because MCMIS does not include axle count data, a required variable for the Bridge Formula. Hence, it is not possible to distinguish between the first three configurations shown in **Figure 17** as they all operate legally at 80,000 lbs. or less. The weight limit also varies for States that allow tractor semitrailers over 80,000 lbs., and therefore additional tractor semitrailer configurations that exceed 80,000 lbs. are possible. However the focus of this analysis is on the potential safety impacts of vehicles with increased sizes and weights; therefore, it is reasonable to compare tractor semitrailers at or below 80,000 lbs. with those with a higher GVW (i.e., 88,000 lbs., 91,000 lbs., and 97,000 lbs.). Furthermore, only CMVs listed as “legally operated” were selected in order to separate the effect on safety performance of overweight trucks from the effect of increased GVW.

It was also difficult to distinguish tractor twin-trailers with a GVW of 80,000 lbs. (control single) from other twin-trailer configurations such as Turnpike Doubles and Rocky Mountain Doubles. One alternative was to examine States that only allow triple-trailer configurations and no other types of long combination vehicles. However, none of the 10 States that allowed triple-trailer configurations identified for this project met this condition. As a result, there are likely some Turnpike Doubles and Rocky Mountain Doubles among the “twin trailers” in this study. This is noted as a limitation in this research, since triple-trailer configuration violations could not be compared due to limited sample size.

| Tractor Semitrailer Configurations  | No. Axles | Interstate Weight Limit  |
|---|-----------|--------------------------|
|  | 3         | 60,000 lbs.              |
|  | 4         | 80,000 lbs.              |
|  | 5         | 80,000 lbs. <sup>a</sup> |
|  | 6         | 80,000 lb. <sup>a</sup>  |

**Figure 17: Tractor Semitrailer Configurations**  
<sup>a</sup> Weight limit is computed from the Bridge Formula

***Vehicles Miles Traveled Data***

The estimated VMT on Interstates for the year 2011 for the 10 States that allow triple-trailer configurations was available at the time of this report (**Table 33**). This table is calculated from an original table of VMT estimates by State, functional class, and the 28 vehicle classes prepared for the overall study. There are three States that have considerably more VMT for twin-trailer

configurations with 5 or 6 axles (3-S2 and 3-S3) as compared to 7, 8, and 9+ axles (2-S1-2-2 or DS7, 3-S3-2 or DS8, and 3-S3-3 or DS9+); these States are Colorado, Kansas, and Oklahoma. There are very few VMT estimates of triple-trailer configurations (including both 2-S1-2-2 or TS7 and 3-S1-2-2 or TS8) for Kansas and Oklahoma, and only four commercial vehicles types were identified as triple-trailer configurations for these three States using MCMIS inspection data. These low levels of VMT for triple-trailer configurations contributed to the low level of inspections for this configuration, ultimately resulting in triple-trailer configurations being dropped from this portion of the study.

**Table 33: 2011 Estimated VMT in Million Miles**

| State     | Twin Trailers |          | Triple Trailers |
|-----------|---------------|----------|-----------------|
|           | DS5 & DS6     | DS7&8&9+ | TS7 & TS8       |
| <b>CO</b> | 53.57         | 7.68     | 10.99           |
| <b>ID</b> | 27.89         | 25.18    | 16.89           |
| <b>KS</b> | 79.04         | 0.44     | 0.00            |
| <b>MT</b> | 16.39         | 37.94    | 3.90            |
| <b>ND</b> | 4.07          | 5.51     | 0.58            |
| <b>NV</b> | 47.15         | 20.70    | 13.41           |
| <b>OK</b> | 54.80         | 0.34     | 0.52            |
| <b>OR</b> | 41.81         | 42.70    | 27.36           |
| <b>SD</b> | 8.08          | 6.92     | 0.73            |
| <b>UT</b> | 15.24         | 8.03     | 1.19            |

Note: DS5/6/7/8/9+ denote double-trailer configurations with five/six/seven/eight/and nine or more axles; TS7/8 denote triple-trailer configurations with seven/eight axles. These categories include the 2-S1-2 double configuration and 2-S1-2-2 and 3-S2-2-2 configurations assessed in the Study.

### Oak Ridge National Laboratory Data

The ORNL data was also provided to the team from FMCSA. This data is based on a study on overweight commercial vehicles and their impact on safety on the Nation’s highways. The data has a similar format to that of the MCMIS inspection files, with two fields added to capture the measured gross vehicle weight and indicate whether the vehicle has a special weight permit. ORNL data was considered a supplement to MCMIS inspection data as it has more accurate gross vehicle weights (the MCMIS data is based on the reports of the field inspectors and may not be based on the actual weight at the time of the inspection). However, the data were not used for the following reasons:

- ORNL data was collected for the years 2012 to 2014 on nationwide basis. The study period for the analysis is from 2008 to 2012 and only focused on the 19 States that allowed heavy semitrailers and/or triple-trailer configurations. This timeframe also allowed comparison with the crash analyses.
- There were 913 inspections matches between the ORNL and MCMIS data files, and 213 of those inspections included meaningful values in the ORNL-added field of gross vehicle weight. Among these 213 inspections, 143 were for tractor semitrailers and none were for twin or triple-trailer combinations.

- Gross vehicle weight recorded in the ORNL file was only for overweight vehicles. As mentioned earlier, the inspection and violations analyses was largely comprised of legally operated CMVs. Therefore, this additional accuracy in GVW provided by the ORNL file did not provide additional insights to the model.

#### **4.5 Data Analysis**

Analysis was conducted to examine the number and rate of violations, out-of-service violations, and whether the carrier was issued a citation in addition to the violation. Safety violations are noted on the vehicle inspection form and must be fixed prior to next re-dispatch of the vehicle. OOS violations are such that operation of the vehicle cannot continue until all OOS violations are immediately remedied, whereas axle or gross weight violations are State-recorded violations that are addressed according to each individual State’s operating procedures; in some cases a citation is issued, and in others the vehicles load might have to be re-balanced or a portion of the load removed before the continuation of the current trip can be resumed.

The statistical analysis is separated into two parts: descriptive and inferential. The descriptive statistics provide summary data for the truck configurations at or below 80,000 lbs. and greater than 80,000 lbs., as reported by the inspector under GVW in the inspection file (in the GROSS\_COMB\_VEH\_WT field) for each analysis conducted. The data are compiled for all 19 States allowing heavy semitrailers or triple trailers that were identified earlier. The data are summarized by violations, out-of-service violations, and whether the carrier was issued a citation in addition to the violation. The inferential statistics are based on regression-based models.

Each analysis was conducted using the statistical software package R, version 3.0.3 (R Core Team, 2012).

#### ***Inspected Commercial Vehicles within the Data Set***

Based on a Level 1 inspection, very few inspected trucks were reported with an overweight violation (see **Table 34**). As expected, the chi-squared test showed that significant differences in the proportion of vehicles that were overweight that operated at or less than 80,000 lbs. when compared to those that operated at greater than 80,000 lb. Hence, the forthcoming analysis is separated into two groups.

**Table 34** is based on information from MCMIS and shows the number of trucks inspected in the field for the 19 States in the analyses. That is, this table includes commercial vehicles with at least one unit as full trailer, pole trailer, semitrailer, straight truck, truck tractor, van, or intermodal chassis, and does not include the specific truck configurations (e.g., tractor semitrailers weighing 80,000 lb).

**Table 34: Number of Inspected Trucks from 2008 to 2012 for 19 States**

| <b>Overweight Violation Noted in MCMIS</b> | <b>Operated at or Below 80,000 pounds</b> | <b>Operated Over 80,000 pounds</b> |
|--|---|------------------------------------|
| No   | 592,534 (97.5%)                           | 105,593 (96.3%)                    |
| Yes  | 15,156 (2.5%)                             | 4,017 (3.7%)                       |

#### ***Violations Analysis***

This section compares average violation counts per inspection for different weight and size configurations. Note that vehicles with any overweight violations in the inspection were excluded from this analysis.

Summary Statistics

A total of 717,300 inspection records were available for the selected 19 States for all trucks in the years 2008 to 2012. Of these, 109,610 inspections are associated with vehicles operating at greater than 80,000 lbs. There are 2,163,666 violations recorded for inspections of all vehicles; 2,151,495 are associated with violations that are not overweight. The average number of violations per inspection for vehicles above and below the 80,000 lb. threshold was compared. There were 2.8 to 3.5 violations per inspection for those vehicles that were not overweight and 6.25 to 7.64 violations per inspection for those vehicles that operate at 80,000 lbs. and above (see **Table 35**). This trend is also present when we examine the data by truck configuration, where twin trailers had more violations per inspection compared to the other truck configurations (see **Table 36**).

**Table 35: Mean Number (Standard Deviation) of Noted Violations per Level 1 Inspection by Weight Threshold for All Truck Configurations**

| GCVW <sup>a</sup> | Overweight Violation Noted in MCMIS | All        | Driver     | Vehicle    | Hazardous Material |
|-------------------|-------------------------------------|------------|------------|------------|--------------------|
| ≤ 80K lb          | No                                  | 2.80 (3.4) | 0.46 (0.9) | 2.24 (2.9) | 0.031 (0.28)       |
|                   | Yes                                 | 6.25 (5.0) | 1.91 (1.4) | 4.18 (4.4) | 0.034 (0.30)       |
| > 80K lb          | No                                  | 3.48 (3.9) | 0.35 (0.8) | 3.05 (3.5) | 0.022 (0.20)       |
|                   | Yes                                 | 7.64 (5.9) | 1.91 (1.5) | 5.57 (5.2) | 0.010 (0.13)       |

K= 1,000 lbs.

<sup>a</sup> Gross combined vehicle weight as reported by the field inspection personnel.

**Table 36: Mean Number (Standard Deviation) of Violations per Inspection by Truck Type**

| Gross Combined Vehicle Weight (GCVW) <sup>a</sup> | All        | Semi-trailer | Twin-Trailer | Triple-Trailer <sup>b</sup> |
|---|------------|--------------|--------------|-----------------------------|
| ≤ 80K lbs   | 2.80 (3.4) | 3.10 (3.6)   | 4.62 (5.7)   | 2.48 (3.6)                  |
| > 80K lbs   | 3.48 (3.9) | 3.42 (3.9)   | 4.94 (5.3)   | 2.83 (4.3)                  |

K= 1,000 lbs.

<sup>a</sup> Gross combined vehicle weight as reported by the field inspection personnel.

<sup>b</sup> As discussed in the body of the report, the number of inspections for triple trailers is very small.

A further breakdown of each semitrailer configuration by weight and average violations per inspection is provided in **Table 37** for the truck configurations in Scenarios 1, 2, and 3 in the study. The mean number of violations per inspection for the tractor-semitrailers with recorded GVW greater than 80,000 lbs. was higher than the control, especially for the 97,000-lb. configuration. However, the large standard deviations suggest that a significant difference in violations per configuration may not be observed. Triple trailers weighing 105,000 lbs. and



129,000 lbs. have seven and four inspection records respectively, and therefore were not included in this table.

**Table 37: Mean Number (Standard Deviation) of Violations per Inspection by Truck and Weight**

| Truck Configuration  | Weight (lb.)  | Violations |
|----------------------|---------------|------------|
| All trucks           | -             | 3.00 (3.6) |
| Tractor Semitrailer  | 80K (control) | 3.38 (3.6) |
|                      | 88K           | 3.54 (3.6) |
|                      | 91K           | 3.66 (4.0) |
|                      | 97K           | 4.04 (3.9) |
| Tractor Twin-trailer | 80K (control) | 4.14 (4.3) |

K = 1,000 lbs.

Summary data (contained in **Appendix F**) were also extracted for the top 15 violation categories for each truck configuration, where similar patterns exist with the same types of violations continually appearing on the list. That is, all truck configurations had violations for braking, lighting, tires, emergency equipment, and windshield. Additionally, all semitrailers and twin-trailers had suspension-related violations.

#### Likelihood of a Violation

A binary logit model was developed to predict the likelihood of a violation given that an inspection had occurred. **Table 38** summarizes the explanatory variables considered in the models. Driver and vehicle age were included as previous studies suggest an association with truck violations.

**Table 38: Explanatory Variables considered for the Logit models**

| Variable                  | Level   | Definition   |
|---------------------------|---------|--|
| Driver Age                | Driver  | $(Date\ of\ inspection) - (Date\ of\ Birth)$   |
| Vehicle Age               | Vehicle | $(Year\ of\ Inspection) - (Model\ Year\ of\ Unit)^*$   |
| Out of Service (OOS) Rate | Carrier | $\frac{(Tot\ \#\ Driver\ Vio) + (Tot\ \#\ Veh\ Viol) + (Tot\ \#\ Haz\ Mat\ Viol)}{(Total\ \#\ of\ Inspections)}$ |

\* For CMVs with multiple units, the oldest one was chosen.

Vehicle age has been associated with crash injuries (Blows et al, 2003) and driver age has been associated with crash risk, types of driving errors, and violations (Harrington and McBride, 1970; Westerman and Haigney, 2000). Driver age is typically correlated with experience level, and several studies have already shown the impact of age on crash risk (e.g., Campbell, 1991). A distribution of driver age for those that encountered an inspection, violation, and citation is shown in **Figure 18**. As noted, the age is fairly normally distributed, so this variable was included as a continuous rather than categorical variable.

Vehicle age was also included as an explanatory variable since older vehicles are more susceptible to inspections and violations (Cantor, et al., 2010). Factors such as safety performance, economic status, and the motor carrier's management policies can affect the safety

performance of its drivers (Mejza, et al., 2003). Due to the limitation of motor carrier information in MCMIS data file, only carrier-wide out-of-service rates were included to predict the likelihood of a truck violation.

**Table 39** shows the results for the logistic regression analysis for tractor semitrailers, where the 80,000-lb. configuration was used as the base (e.g., included in the intercept). This first model shows how the explanatory variables relate to whether a tractor semitrailer is more likely to receive a violation. Correlations between each of the two explanatory variables are all lower than 0.15.

**Table 39: Likelihood of a Violation Given a Level 1 Inspection – Alternative Tractor Semitrailer Configurations**

| <i>Variable</i>          | <b>Log Odds</b> |                   |                |                | <b>Odds Ratio</b> |                         |        |
|--------------------------|-----------------|-------------------|----------------|----------------|-------------------|-------------------------|--------|
|                          | <i>Estimate</i> | <i>Std. Error</i> | <i>z value</i> | <i>p-value</i> | <i>Estimate</i>   | <i>[95% Conf. Int.]</i> |        |
| (Intercept)              | 0.767           | 0.074             | 10.388         | < 0.0001       |                   |                         |        |
| <b>88K Configuration</b> | -0.057          | 0.151             | -0.378         | 0.7060         | 0.944             | 0.707                   | 1.279  |
| <b>91K Configuration</b> | -0.043          | 0.089             | -0.485         | 0.6270         | 0.958             | 0.807                   | 1.142  |
| <b>97K Configuration</b> | -0.181          | 0.115             | -1.574         | 0.1160         | 0.835             | 0.669                   | 1.049  |
| <b>Driver Age</b>        | -0.012          | 0.001             | -8.754         | < 0.0001       | 0.988             | 0.985                   | 0.990  |
| <b>Vehicle Age</b>       | 0.066           | 0.003             | 21.958         | < 0.0001       | 1.068             | 1.062                   | 1.074  |
| <b>Carrier OOS Rate</b>  | 2.407           | 0.144             | 16.711         | < 0.0001       | 11.103            | 8.399                   | 14.771 |

Null Deviance = 26200

Residual Deviance = 24965

N = 23047

K = 1,000 lbs.

Note: Configuration base is 80,000 lbs.

This model suggests that vehicle weights (88,000 lbs., 91,000 lbs., and 97,000 lbs.) are not particularly good predictors of safety-related violations when vehicle age, driver age, and carrier OOS rates are accounted for in the model. Older drivers (perhaps due to experience) have a reduced likelihood of receiving a violation, whereas using older equipment increases the likelihood of a violation as older vehicles may require more general maintenance as compared to new vehicles. However, a carrier with a high OOS rate is (intuitively) a good predictor that vehicle safety violations will be identified by roadside inspectors conducting inspections. These findings have direct implications for the use of heavier combination vehicles. If carriers that enter the market using the heavier 3-S3 vehicles also have higher OOS and older equipment, this model suggests they may have higher violation rates as well.

For the data compiled for all 19 States, 7 inspection records were identified for triple-trailer combinations weighing 105,000 lbs., and 4 for triple-trailer combinations weighing 129,000 lbs. This small sample size may introduce non-coverage bias and incorrect estimates of errors. A logit model for triple-trailer configurations cannot, therefore, be estimated.

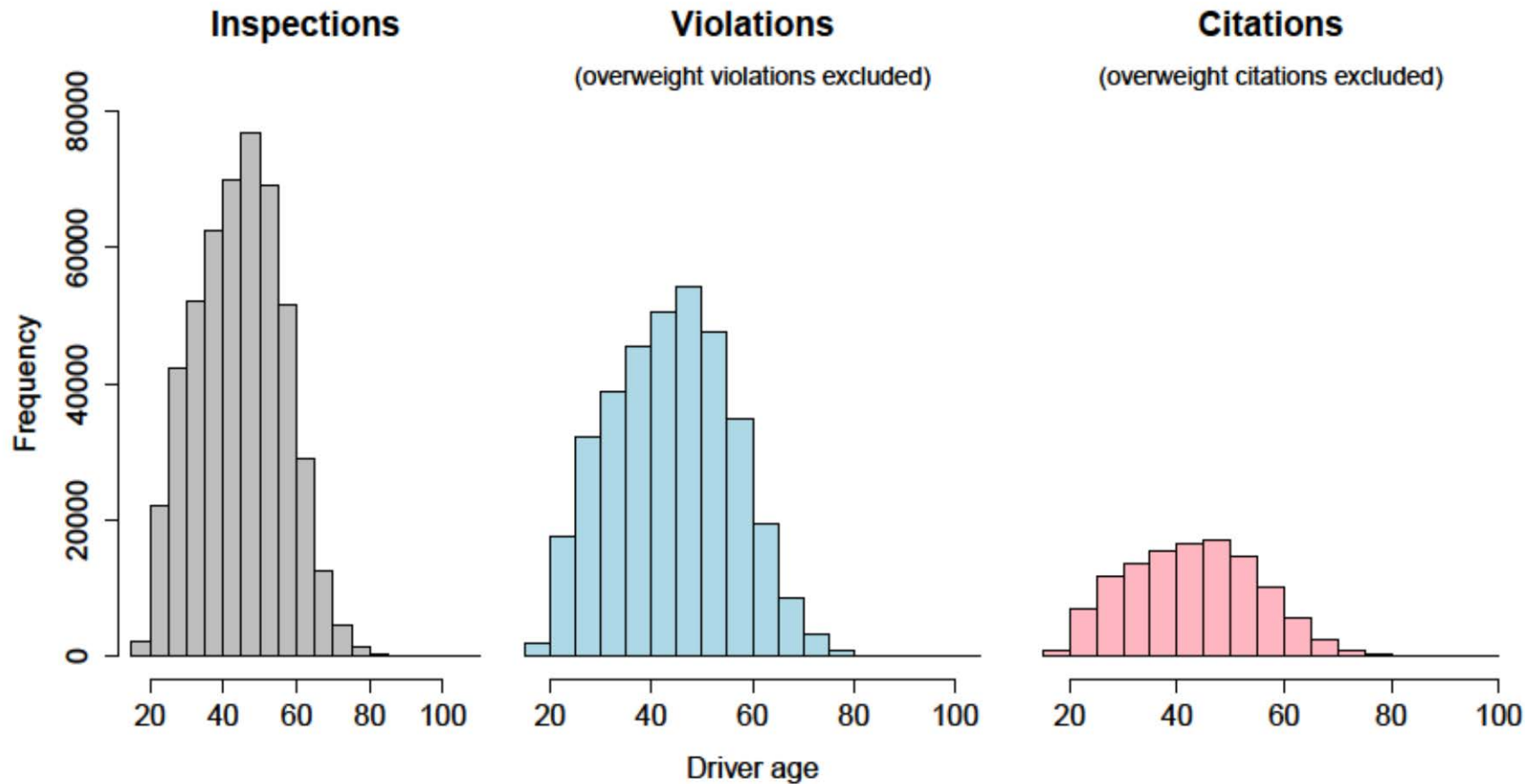


Figure 18: Distribution of Driver Age for the 19 States in the Analyses (2008–2012).

#### 4.6 Out-of-service Violations Analysis

##### Summary Statistics

The study team considered OOS violations at the vehicle level. Vehicles inspected with overweight violations, as noted on roadside inspection reports, had OOS rates more than two times higher than vehicles with no overweight violations; vehicles over 80,000 lbs. also had more OOS violations (**Table 40**). The twin-trailer configurations had the highest proportion of OOS violations per inspection (with an average of one or more OOS violations per inspection in each GVW grouping) and triple-trailers had the lowest with an average of 0.5 OOS violations per inspection in each GVW grouping (**Table 41**).

**Table 40: Mean Number (Standard Deviation) of OOS Violations per Inspection by Weight Threshold for All Truck Configurations.**

| GCVW <sup>a</sup> | Overweight Violation Noted in MCMIS | All        | Driver     | Vehicle    | Hazardous Material |
|-------------------|-------------------------------------|------------|------------|------------|--------------------|
| ≤ 80K lbs.        | No                                  | 0.58 (1.2) | 0.08 (0.3) | 0.46 (1.1) | 0.011 (0.14)       |
|                   | Yes                                 | 1.35 (1.9) | 0.12 (0.4) | 1.12 (1.7) | 0.015 (0.17)       |
| > 80K lbs.        | No                                  | 0.67 (1.3) | 0.05 (0.3) | 0.56 (1.2) | 0.004 (0.07)       |
|                   | Yes                                 | 1.57 (2.2) | 0.07 (0.3) | 1.38 (2.1) | 0.001 (0.03)       |

K = 1,000 lbs.

<sup>a</sup> Gross combined vehicle weight as reported by the field inspection personnel.

**Table 41: Mean Number (Standard Deviation) of OOS Violations per Inspection by Truck Type**

| GCVW <sup>a</sup> | All        | Semitrailer | Twin-trailer | Triple-trailer |
|-------------------|------------|-------------|--------------|----------------|
| ≤ 80K lbs.        | 0.58 (1.2) | 0.64 (1.3)  | 1.01 (2.2)   | 0.54 (2.0)     |
| > 80K lbs.        | 0.67 (1.3) | 0.65 (1.3)  | 1.10 (1.9)   | 0.57 (2.0)     |

K = 1,000 lbs.

<sup>a</sup> Gross combined vehicle weight as reported by the field inspection personnel.

These violation counts are further broken down by vehicle weight (including double-trailer configurations) in **Table 42** and as noted, twin trailers have the highest OOS violation count. Similarly, triple trailers weighing 105,000 lbs. and 129,000 lbs. were not included because of the very limited sample size.

**Table 42: Mean (Standard Deviation) Company-Level Violations Per Inspection by Configuration and Weight**

| Truck Configuration | Weight (lbs.) | Violations |
|---------------------|---------------|------------|
| All trucks          | -             | 0.62 (1.3) |
| 3-S2                | 80K (control) | 0.64 (1.2) |
| 3-S2                | 88K           | 0.59 (1.1) |
| 3-S3                | 91K           | 0.72 (1.4) |
| 3-S3                | 97K           | 0.82 (1.4) |
| Twin-trailer        | 80K (control) | 0.84 (1.5) |

K = 1,000 lbs.

**Likelihood of an OOS Violation**

A binary logit model was developed to analyze the likelihood of an OOS violation occurring during an inspection for GVW violations. The same explanatory variables were used as in prior models. Driver age, vehicle age, and carrier OOS rate were analyzed to determine relative significance as a factor in the prediction of an OOS violation occurring during a roadside inspection. The data analysis, in **Table 43**, shows that there was an increase in violations from the 80,000-lb. control vehicle to the 88,000-lb. configuration, but there was an inability to show a difference in the other two weight categories.

**Table 43: Likelihood of OOS Violation given a Level 1 Inspection – Alternative Tractor Semitrailer Configurations**

| Variable                 | Log Odds |            |         |          | Odds Ratio |                  |        |
|--------------------------|----------|------------|---------|----------|------------|------------------|--------|
|                          | Estimate | Std. Error | z value | p-value  | Estimate   | [95% Conf. Int.] |        |
| (Intercept)              | -1.426   | 0.069      | -20.531 | < 0.0001 |            |                  |        |
| <b>88K Configuration</b> | 0.216    | 0.135      | 1.606   | 0.1080   | 1.241      | 0.951            | 1.612  |
| <b>91K Configuration</b> | -0.055   | 0.081      | -0.671  | 0.5020   | 0.947      | 0.806            | 1.109  |
| <b>97K Configuration</b> | 0.040    | 0.110      | 0.364   | 0.7160   | 1.041      | 0.837            | 1.289  |
| <b>Driver Age</b>        | -0.009   | 0.001      | -6.893  | < 0.0001 | 0.991      | 0.988            | 0.993  |
| <b>Vehicle Age</b>       | 0.058    | 0.002      | 25.757  | < 0.0001 | 1.060      | 1.055            | 1.064  |
| <b>Carrier OOS Rate</b>  | 2.583    | 0.098      | 26.479  | < 0.0001 | 13.232     | 10.943           | 16.039 |

Null Deviance = 27956

Residual Deviance = 25944

N = 23047

K = 1,000 lbs.

Note: Configuration base is 80,000 lbs.

**Citations Analysis**

This section analyzes the citations received during inspection. Citations are the most severe form of a violation. As with the previous analyses, inspections that resulted in an overweight violation were excluded. There are 149,977 citation records included in this analysis.

Summary Statistics

The USDOT study team compared the mean number of citations per inspection for vehicles at the 80,000-lb. threshold between overweight and not overweight vehicles and among the triple-trailer configurations. All vehicles with overweight violations have more citations regardless of whether they are heavier than 80,000 lbs. or not (see **Table 44**). A similar summary based on truck configuration is provided in **Table 45** and shows that tractor twin-trailers have more citations per inspection.

**Table 44: Mean Number (Standard Deviation) of Citations per Inspection by Weight Threshold for All Truck Configurations.**

| GCVW <sup>a</sup> | Overweight Violation Noted in MCMIS | All        | Driver     | Vehicle    | Hazardous Material |
|-------------------|-------------------------------------|------------|------------|------------|--------------------|
| ≤ 80K lb          | No                                  | 0.42 (1.2) | 0.14 (0.5) | 0.98 (0.3) | 0.004 (0.09)       |
|                   | Yes                                 | 1.61 (2.1) | 0.91 (0.9) | 1.50 (0.6) | 0.009 (0.14)       |
| > 80K lb          | No                                  | 0.35 (1.2) | 0.07 (0.3) | 1.05 (0.2) | 0.002 (0.05)       |
|                   | Yes                                 | 1.84 (3.3) | 0.83 (0.9) | 2.84 (0.9) | 0.002 (0.04)       |

K = 1,000 lbs.

<sup>a</sup> Gross combined vehicle weight as reported by the field inspection personnel.

**Table 45: Mean Number (Standard Deviation) of Citations Per Inspection by Truck Type**

| GCVW <sup>a</sup> | All        | Semitrailer | Twin-Trailer | Triple-Trailer <sup>b</sup> |
|-------------------|------------|-------------|--------------|-----------------------------|
| ≤ 80K lb          | 0.42 (1.2) | 0.41 (1.2)  | 0.53 (1.4)   | 0.12 (0.6)                  |
| > 80K lb          | 0.35 (1.3) | 0.34 (1.1)  | 0.66 (2.2)   | 0.11 (0.7)                  |

K = 1,000 lbs.

<sup>a</sup> Gross combined vehicle weight as reported by the field inspection personnel.

<sup>b</sup> Triple-trailers based on small sample size.

A further breakdown of each configuration by weight and average citations per inspection is provided in **Table 46**. Similarly, triple trailers weighing 105,000 lbs. and 129,000 lbs. were not included because of the limited sample size.

**Table 46: Mean Number (Standard Deviation) of Citations per Inspection by Truck Configuration and Weight**

| Truck Configuration | Weight (lbs.) | Violations |
|---------------------|---------------|------------|
| All trucks          | -             | 0.44 (1.3) |
|                     | 80K (control) | 0.39 (1.1) |
| Semitrailer         | 88K           | 0.36 (1.0) |
|                     | 91K           | 0.77 (2.4) |
|                     | 97K           | 0.46 (1.1) |
| Twin-trailer        | 80K (control) | 0.46 (1.0) |

K = 1,000 lbs.

### Likelihood of a Citation

A binary logit model was developed to examine the likelihood of a citation occurring given a Level 1 inspection. **Table 47** shows the findings for the logit model for tractor semitrailers, where once again the 80,000-lb. configuration was used as the base (e.g. included in the intercept).

**Table 47: Likelihood of a Citation Given a Level 1 Inspection – Alternative Tractor Semitrailer Configurations**

| <i>Variable</i>          | <b>Log Odds</b> |                   |                |                | <b>Odds Ratio</b> |                         |       |
|--------------------------|-----------------|-------------------|----------------|----------------|-------------------|-------------------------|-------|
|                          | <i>Estimate</i> | <i>Std. Error</i> | <i>z value</i> | <i>p-value</i> | <i>Estimate</i>   | <i>[95% Conf. Int.]</i> |       |
| (Intercept)              | -1.456          | 0.075             | -19.461        | < 0.0001       |                   |                         |       |
| <b>88K Configuration</b> | -0.656          | 0.180             | -3.650         | 0.0003         | 0.519             | 0.360                   | 0.729 |
| <b>91K Configuration</b> | -0.142          | 0.090             | -1.577         | 0.1148         | 0.868             | 0.726                   | 1.033 |
| <b>97K Configuration</b> | -0.196          | 0.126             | -1.553         | 0.1205         | 0.822             | 0.638                   | 1.047 |
| <b>Driver Age</b>        | -0.013          | 0.001             | -8.837         | < 0.0001       | 0.987             | 0.984                   | 0.990 |
| <b>Vehicle Age</b>       | 0.044           | 0.002             | 19.044         | < 0.0001       | 1.045             | 1.040                   | 1.049 |
| <b>Carrier OOS Rate</b>  | 1.908           | 0.090             | 21.152         | < 0.0001       | 6.736             | 5.649                   | 8.045 |

Null Deviance = 23699

Residual Deviance = 22539

N = 23047

K = 1,000 lbs.

Note: Configuration base is 80,000 lbs.

#### **4.7 Summary**

Using data obtained from MCMIS and the study team, a series of analyses were conducted to explore the relationship between vehicle configurations and violations. Separate analyses compared an 80,000-lb. five-axle combination to an 88,000-lb. six-axle configuration, a 91,000-lb. six-axle configuration, and a 97,000 lb. six-axle configuration. A comparison of the 80,000-lb. twins with heavier triple-trailer configurations was also explored, but the small sample size (less than 10) limited the opportunities for an inferential analysis.

Commercial motor vehicles heavier than 80,000 lbs. appear to have more overweight violations. Vehicles with overweight violations also have more types of other, additional violations compared to vehicles that do not have overweight violation. This observation is also applicable for commercial vehicles operating both at or below 80,000 lbs. as well as at greater than 80,000 lbs. As for vehicles without overweight violations (referred to as “legally operated” in this section), those weighing more than 80,000 lbs. have higher violation rates in general and also have higher OOS violation rates, which are primarily due to vehicle-related violations.

The study team only conducted analyses by truck configuration for “legally operated” vehicles. This was because vehicles are identified with the reported GVW noted by field inspectors. Illegally operated vehicles (those with overweight violations) were therefore dropped to distinguish the effect of violations among overweight trucks as compared to those among trucks with increased GVW. Notably, although the sample size for triple-trailer combinations was fairly small, the summary statistics does suggest that these configurations have lower violations and OOS violation rates as compared with twin-trailer combinations.

Tractor semitrailers that weigh greater than 80,000 lbs. experienced more overall violations per inspection. Among tractor semitrailers, twin trailers, and triple trailers, twin trailers have the highest violation rates. Vehicles weighing more than 80,000 lbs. have higher OOS and non-OOS

violation rates for all three combination types. Not all truck configurations with higher GVWR had higher OOS violation rates. That said, when truck configuration was included in the regression models (with other factors accounted for), this variable was not a significant predictor of the likelihood of a violation, not even an OOS violation.

The strongest predictors of the likelihood of an OOS or non-OOS violation were associated with driver age, vehicle age and company OOS record. An increase of 10 years in driver age will lead to a 9 percent decrease in the likelihood of an OOS violation and an 11 percent decrease in the likelihood of a non-OOS violation. Every increase of 5 years in vehicle age increases the likelihood of a non-OOS violation or an OOS violation by 1.39 and 1.34 times, respectively. A one-unit increase in the carrier OOS rate will result in an increase of 11.10 and 13.23 for non-OOS violations and OOS violations, respectively.

As mentioned previously, carrier OOS rate is intuitively a good predictor as carriers with higher OOS rate are more likely to be involved in roadside inspections and are therefore more likely to receive violations. The analyses are limited to the data available in the MCMIS inspection file, which we recognize is subject to the subjective recordings of the roadside inspector. These inspectors may also have their own biases with respect to the CMVs and motor carriers that they perceive as being likely candidates for a violation. However, it should be noted that, even under these circumstances, there are no significant differences in tractor semitrailers weighing 88,000 lbs., 91,000 lbs., and 97,000 lbs. when compared to semitrailers weighing 80,000 lbs. with respect to violations. This indicates that these alternative tractor semitrailer configurations do not appear to be worse than the reference semitrailer group in the current analyses.

As for the top violation categories by truck configuration (see **Appendix F**), brake violations (including “Brakes, all other violations” and “Brakes, out of adjustment”) always account for the highest proportion of all violations. Compared with vehicles operated at or below 80,000 lbs, vehicles operating at greater than 80,000 lbs. show a higher percentage (18 percent) of brake violations and a higher number (0.76) of brake violations per inspection. For the four tractor semitrailer configuration groups, “Brakes, all other violations” all account for about 35 percent of all violations, whereas the percentage of “Brakes, out of adjustment” for semitrailers greater than 80,000 lbs. is typically 2 points higher. As for triple trailers, brake violations are 4 percentage points higher than they are for twin trailers, although triple configurations receive one less brake violation per inspection as compared to twin trailers.



## CHAPTER 5 - SCENARIO ANALYSIS

The goal of this analysis was to estimate for each scenario the annual changes in the number of rural and urban Interstate crashes that would be expected to occur if the alternative truck configurations were to operate nationwide on Interstates and National Highway System (NHS) roadways. As previously discussed, vehicle weight-based data was constrained primarily to Interstate System roadways, rendering an analysis of NHS roadways impossible.

In each scenario, the number of annual crashes was to be calculated for a “base” condition in which the nationwide Interstate VMT is based on the current operation of the alternative configuration (i.e., operation in a limited number of States) and for a “scenario” condition in which nationwide Interstate VMT is based on allowing the alternative trucks to operate in all States. The base and scenario Interstate VMT estimates that were to be used here are those described in Chapter 3 of the *Volume II: Modal Shift Comparative Analysis* and are the same estimates used in other areas of the study.

The change in crashes between the base and scenario conditions in each scenario was to be calculated as follows:

1. Calculate base condition crashes for each truck configuration – For each truck configuration affected by the scenario (i.e., five-axle semitrailer (control single) and six-axle semitrailer configurations in Scenario 2 and Scenario 3; five-axle semitrailer (control double) and seven- and nine-axle triple configurations in Scenario 5 and Scenario 6), multiply the base condition VMT for that truck configuration by the crash rate for that configuration. The crash rates that were to be used are those calculated from the State crash data as described earlier and in Chapter 2 of this report.
2. Sum base condition crashes for each configuration to develop the total number of base-condition crashes.
3. Calculate scenario condition crashes (assumes operation throughout the United States) for each truck configuration – For each truck configuration affected, multiply the scenario condition VMT for that truck configuration by the crash rate for that configuration. The crash rates that were to be used are again those calculated from the State crash data as described earlier.
4. Sum scenario condition crashes for each configuration to develop the total number of scenario condition crashes.
5. Calculate the change in total crashes by subtracting base condition crashes (Step 2 output) from scenario condition crashes (Step 4 output).
6. Calculate the percent change in crashes by dividing the change (Step 5 output) by the base condition total (Step 2 output).

Calculations were initially attempted for Scenarios 2, 3, 5 and 6. In each Scenario, the calculations were planned to be conducted separately for urban Interstates and rural Interstates and then would be summed to produce results for Total (urban plus rural) Interstates. As noted before, analyses could not be conducted for Scenarios 1 and Scenario 4 since crash rates could not be developed for the alternative truck configurations in these scenarios.

The crash rates that were to be used in these calculations are from one State (Washington) for Scenario 2 and two States (Idaho and Michigan) for Scenario 3. The team believes these are the

best estimates that can be currently obtained for the crash implications of the scenarios to be investigated. Ultimately due to the limited number of States with suitable data, FHWA determined the analysis of crash rates cannot generally be extended to other States or be used to forecast national impacts.,

Both Scenarios 2 and 3 include the alternative truck configuration of a six-axle tractor semitrailer. Scenario 2 has a GVW of 91,000 lb., while Scenario 3 has a 97,000 lb. GVW. The control vehicle in both scenarios is a five-axle tractor semitrailer with a GVW of 80,000 lb. The crash rates used for Scenario 2 are based on the analysis of Washington State data, where the allowable GVW for six-axle tractor semitrailers is approximately 92,000 lb., which is very close to the 91,000 lb. alternative configuration target value. The crash rates used for the Scenario 3 analysis are a combination of the rates from Michigan and Idaho as described in the note under **Table 46**. The allowable GVW in both States is 105,500 lb., which is higher than the 97,000 lb. alternative configuration target.

The concept underlying the development of the estimates of changes in truck crashes within each scenario required two components – *nationally-representative* crash rates for each truck configuration and estimates of national VMT for both a base case of existing truck configurations and roadway networks and for a Scenario case involving alternative configurations and roadway networks. The study team faced significant data limitation including:

- The findings for the Scenario 2 91,000 lb. 3-S3 configuration and the findings for the Scenario 5 and 6 triple-trailer configurations were each based on crash rates from one State. The findings for the Scenario 3 97,000 lb. 3-S3 configuration were based on crash rates from two States. The use of rates from this limited number of States clearly raises questions concerning whether these rates can be considered nationally representative, and thus concerning whether using them to predict nationwide estimates is appropriate.
- Analysis was only attempted on Interstate roadways. It was not possible to even attempt to conduct analyses on non-Interstate roads due to limitations in both the crash and exposure data.
- Since there is no information on operating GVW for each truck in State crash data, the definition of truck crashes used in the different scenarios was based on trailer and axle counts and GVW limits in the States. Whether or not the actual GVWs for trucks in the fleet analyzed in this study will be similar to the actual GVWs of an expanded fleet in the future is unknown.
- The composition of the future fleets of alternative vehicles may differ from the current fleet that was analyzed in other unknown ways. For example, the same alternative configuration analyzed here (e.g., 129,000 lb. triple-trailer configurations) may carry different commodities in the future. If so, the carriers may differ, which in turn may cause the “safety culture” to differ (e.g., driver training, driver experience, truck maintenance procedures, equipment age, etc.) The effect of such possible differences could not be analyzed here. For example, while crash data contains information on driver age, there is no driver-age-specific truck exposure data, a critical need in any analysis of driver age effects.

FHWA believed these data limitations raise significant questions concerning the accuracy, reliability and validity of any nationally-representative crash rate estimates that could be

calculated for each truck configuration. Thus, meaningful national level results could not be developed for this study.

## CHAPTER 6 - CONCLUSIONS

The earlier chapters in this report have provided details of the three different types of safety analysis conducted in this effort – (1) crash-based analyses, (2) analysis of vehicle stability and control through simulation, and (3) analysis of safety inspections and violations data. The analyses conducted clearly indicate that the safety implications of the alternative vehicle configurations vary across the array of vehicles examined. Of interest here is whether the findings from the crash-based analyses, the vehicle stability and control analyses, and the inspection and violations analyses supported each other.

### *Tractor-Semitrailer Analyses*

In general, for Scenarios 2 and 3, in the limited number of States that could be analyzed, the six-axle alternative truck configurations have higher crash rates than the five-axle tractor-semitrailer control truck configurations, particularly the 97,000-lb., six-axle alternative truck configuration. The consistency of results across the three States whose data were used strengthens the validity of the results.

The Scenario 2 crash analysis showed no significant differences in injury severity distributions between the control tractor-semitrailer and the alternative configuration. However, in the Scenario 3 analyses, both the Idaho and Michigan data indicated that the six-axle alternative configuration was generally involved in less severe crashes compared to the five-axle control configuration.

These crash-based findings for the five- and six-axle trucks differed from the findings for the vehicle stability and control modeling analysis and the safety inspection and violations analyses. The vehicle stability and control analyses showed marginal differences between the control tractor-semitrailer and the Scenario 2 and 3 alternative truck configurations for the maneuvers evaluated. The violations analyses did not indicate a clear pattern of association between control and alternative truck configurations in violations or out-of-service decisions and citations.

### *Comparative Analysis of Triple Trailer and Twin-trailer Configurations*

In general, the Scenario 5 and 6 findings involving triple-trailer alternative configurations also differed to some extent between the three analyses. While no differences in crash rates between triple-trailer and twin-trailer configurations was seen in the Scenario 6 Kansas Turnpike data, the crash rate analyses for Idaho (Scenario 5) indicated the rates for the triple-trailer configuration to be significantly lower than those for the twin-trailer configuration.

With respect to crash severity, no difference was found between twin-trailer and triple-trailer configurations in the Scenario 6 Kansas Turnpike data. However, the Scenario 5 Idaho triple-trailer configuration involvements appear to be somewhat less severe than those of the twin-trailer configuration on rural Interstates ( $p=0.09$ ). No differences are seen on urban Interstates or when urban and rural are combined. Fleet analyses indicate a higher likelihood of severe outcomes for the triple-trailer configurations compared to those of the double-trailer, but only when considering outcomes for non-truck occupants.

The crash-based findings of differences in both crash rate and crash severity in Scenario 5 differed from the vehicle stability and control and the violations findings. The vehicle stability and control analysis of the triple combinations showed minor differences between the twin-trailer control vehicle and the alternative truck configurations for the set of maneuvers evaluated. The greatest difference was in the low-speed off-tracking maneuver. The safety inspections and violations analysis did not produce any findings for twin trailer compared with triple-trailer configurations due to the small sample sizes. In both the control and alternative configuration analyses, the differences between the findings for crash rate and crash severity versus the findings for vehicle control and simulations could result from the fact that, while crash rates reflect actual operations with various drivers in a variety of traffic, roadway and environmental conditions, the simulation-based analyses addresses specific controlled conditions that lack real-world operators or operating conditions.

### ***Data Improvement in Crash-Based and Inspection-Based Studies***

A major conclusion of this overall effort is that crash-based studies of truck size and weight in the United States are very difficult to conduct successfully. This is particularly true if the studies are based on the primary data sources used in this study – State crash files, State roadway inventory data, State AADT data, and additional data on VMT for specific truck configurations. The issues found in the data used in this study are not new, and many of them have been documented before.

It is very likely that national-level questions concerning the safety effects of changes in truck size and weight will continue to be asked in the future. However, given the current data limitations, the same problems encountered in this study and in past studies will be encountered again. While existing roadway inventory and AADT data will likely be sufficient for use in future studies, major improvements are needed in the availability of crash data and VMT data for specific truck configurations.

### Crash Data Needs

It is imperative that a data set be carefully assembled over time that includes precise information about the configurations and weights of the vehicles involved in crashes. While it may not be possible to have the investigating police officer report the actual GVW on crash report forms (since the truck operator does not possess that information), at a minimum, it should be possible for the investigating officer to accurately report a count of trailers, a count of total axles, and the length of each trailer for combination vehicles involved in crashes. However, only 7 of the 17 States allowing the operation of a triple-trailer configuration under the ISTEA LCV Freeze had an axle count variable, and 1 of them stopped collecting these data in 2010. Only 9 of the 15 States originally examined for heavy semitrailer operation had an axle count variable. Almost no States capture information on trailer length—again, a variable easily measured at the crash site.

### Configuration-specific VMT Needs

The single current source of State and national truck VMT information for the configurations of interest in this study (plus additional configuration) is the WIM data described earlier. WIM data were used in this study to derive VMT estimates for 28 detailed vehicle classes. FHWA's vehicle

classification data includes 13 different vehicle types and combines both twin trailer and triple-trailer configurations with other truck types, so the routine counts had to be supplemented with WIM data to provide the needed classifications that include a gross vehicle weight attribute. Unfortunately, the number of WIM data collection points is limited enough that the needed VMT estimates could only be provided at the State functional class level. Even the VMT estimates for rural and urban Interstates for individual States were often based on a very limited number of WIM stations within each roadway classifications. In addition, they could not be used to estimate VMT for a specific configuration (e.g., heavy triple-trailer configurations) on a given route. The ability to extrapolate WIM estimates to specific routes would be very important in future attempts to model target truck crashes on non-Interstate roads or to better model truck crashes on Interstate routes such that the effect of AADT changes on truck crashes per mile driven can be more accurately defined.

### Inspection-based Data Needs

The MCMIS inspection data used to support the inspection and violations analysis included the selection of the gross vehicle weight variable, “Gross Combination Vehicle Weight” (i.e. GROSS\_COMB\_VEH\_WT), which is defined in the MCMIS data dictionary as the measured weight of the combination vehicle in the field. After the analysis was nearly complete, discussions with FMCSA indicated that this variable is not always available in the file as a measured weight. Subsequent discussions with FMCSA staff revealed that no better variable existed in MCMIS for a description of combination vehicle weight, so the team elected to proceed with the analysis. Consistent recording of accurate combination vehicle weight is necessary to support future studies.

### *Summary*

In summary, without data improvements, future studies will continue to experience difficulties in quantifying the safety implications of alternative truck sizes and weights.

## REFERENCES

- Abdel-Rahim, A., S. G. Berrio-Gonzales, et al. (2006b). Longer Combinations Vehicles: A Comparative Crash Rate Analysis. Final Report Part B. University of Idaho. National Institute for Advanced Transportation Technology.
- Al-Ghamdi, A. (2007), A Comparison of Accident Rates Using the Likelihood Ratio Testing Technique, *Civil Engineering Systems*, Vol 10(3), pp. 175-186.
- American Association of State Highway and Transportation Officials (2010). *Highway Safety Manual*. Washington, DC.
- American Association of State Highway and Transportation Officials (2011). *A Policy on Geometric Design of Highways and Streets*, 6th edition. Washington, DC.
- Blows, S., R Q Ivers, M Woodward, J Connor, S Ameratunga and R Norton. (2003). Vehicle year and the risk of car crash injury. *Injury Prevention*, pp. 353-356.
- Campbell, K. L., D. F. Blower, et al. (1988). Analysis of accident rates of heavy-duty vehicles. Final report. Ann Arbor, Mich., University of Michigan, Transportation Research Institute.
- Campbell, K.L. (1991). Fatal accident involvement rates by driver age for large trucks. *Accident Analysis and Prevention*, Vol 23(4), pp. 287-295.
- Campbell, K. L., D. F. Blower, et al. (1996). Sources of exposure data for safety analysis. Ann Arbor, Mich., University of Michigan, Transportation Research Institute.
- Cantor, D.E., Corsi, T.M., Grimm, C.M., Ozpolat. (2010). A driver focused truck crash prediction model. *Transportation Research Part E*, Vol. 46(5), pp. 683-692.
- CDM Smith (February 2014). *Vehicle Stability and Control, Final Draft Project Plan and Schedule*.
- FHWA (2014), MAP-21 Comprehensive Truck Size and Weight Limits Study Website. Available at <http://www.ops.fhwa.dot.gov/freight/SW/map21tswstudy/index.htm> as of June 2014.
- FHWA (2000a). Comprehensive Truck Size and Weight Study. Washington DC, U.S. Department of Transportation. Publication Number: FHWA-PL-00-029 (Volume II Issues and Background) HPTS, August. Available at <http://www.fhwa.dot.gov/reports/tswstudy/Vol2-Chapter6.pdf> as of May 30, 2014.
- FHWA (2000b). Comprehensive Truck Size and Weight Study. Washington DC, U.S. Department of Transportation. Publication Number: FHWA-PL-00-029 (Volume III Scenario Analysis, Chapter 8 Safety) HPTS, August. Available at <http://www.fhwa.dot.gov/reports/tswstudy/Vol3-Chapter8.pdf> as of May 30, 2014.
- Fisher, R.A. (1922), "On the Interpretation of  $\chi^2$  from Contingency Tables, and the Calculation of P". *Journal of the Royal Statistical Society*, 85(1), pp. 87-94.

- Fridstrom, L., Ifver, J., Ingebrigtsen, S., Kulmala, R., and Thomsen, L. K. (1995). Measuring the contribution of randomness, exposure, weather, and daylight to the variation in road accident counts. *Accident Analysis and Prevention*, Vol. 27 (1), pp. 1–20.
- Harrington, DM, and McBride, RS. (1970). Traffic Violation by Type, Age, Sex, and Marital Status. *Accident Analysis and Prevention*, pp. 67-79.
- Hauer, E. (2001). “Over-dispersion in modelling accidents on road sections and in empirical Bayes estimation,” *Accident Analysis and Prevention*, Vol. 33(6), November 2001, pp. 799-808.
- Hauer, E. (2004). “The harm done by tests of significance.” *Accident Analysis and Prevention*, Vol. 36 (5), 2004, pp. 495-500.
- Hoover, R.L., et al. (2005). “Air Disc and S-cam Brake Stopping Performance Comparison for Class 8 Tractor and Trailer Combinations” SAE Paper 2005-01-3614.
- International Organization for Standardization, (2000). “Road vehicles — Heavy commercial vehicle combinations and articulated buses — Lateral stability test methods.” ISO 14791:2000(E).
- Lascurain, M.B., Capps, G., and Franzese, O. (October 2013), “Heavy and Overweight Vehicle Brake Testing: Combination Five-Axle Tractor-Flatbed Final Report.” ORNL/Pub40701,.
- Lascurain, M.B., Capps, G., and Franzese, O. (Publication expected 2014). “Heavy and Overweight Vehicle Brake Testing: Combination Six-Axle Tractor-Flatbed Final Report.”.
- Mehta C.R., Patel N.R. (1983). "A Network Algorithm for Performing Fisher's Exact Test in r Xc Contingency Tables". *Journal of the American Statistical Association* 78 (382): 427–434.
- Mejza, MC, Richard E. Barnard, Thomas M. Corsi and Thomas Keane. (2003). Driver Management Practices of Motor Carriers with High Compliance and Safety Performance. *Transportation Journal Vol. 42, No. 4, ,* pp. 16-29.
- Miaou, S.P. (1996). *Measuring the Goodness-of-fit of Accident Prediction Models*. Federal Highway Administration, FHWA-RD-96-040, Oak Ridge, TN: Oak Ridge National Laboratory.
- MMUCC (2012). MMUCC Guideline, Model Minimum Uniform Crash Criteria (Fourth Edition). Available at [http://mmucc.us/sites/default/files/MMUCC\\_4th\\_Ed.pdf](http://mmucc.us/sites/default/files/MMUCC_4th_Ed.pdf).
- Montufar, J., J. D. Regehr, et al. (2007). Long Combination Vehicle (LCV) Safety Performance in Alberta: 1999-2005. Alberta, CA, Alberta infrastructure and Transportation Policy and Corporate Services Division.
- Regehr, J. D., J. Montufar, et al. (2009). "Safety performance of longer combination vehicles relative to other articulated trucks." *Canadian Journal of Civil Engineering* 36(1): 10.
- Rao, S.J., et al. (2013a). “Validation of Real Time Hardware in the Loop Simulation for ESC Testing with a 6×4 Tractor and Trailer Models” SAE Paper 2013-01-0692.
- Rao, S.J., et al. (2013b). “Modeling of a 6×4 Tractor and Trailers for Use in Real Time Hardware in the Loop Simulation for ESC Testing” SAE Paper 2013-01-0693.



R Core Team (2012). R: A language and environment for statistical computing. R Foundation for Statistical Computing, Vienna, Austria. ISBN 3-900051-07-0, URL <http://www.R-project.org/>.

SAE International (2000). A Test for Evaluating the Rearward Amplification of Multi-Articulated Vehicles (Cancelled Sep 2000). J2179

Transportation Research Board (2011). *Model Curriculum for Highway Safety Core Competencies*. NCHRP Report 667. Washington, DC.

Transportation Research Board (2002). *Regulation of Weights, Lengths, and Widths of Commercial Motor Vehicles*. Special Report 267. Washington, DC.

Transportation Research Board (1990b). *New Trucks for Greater Productivity and Less Road Wear: An Evaluation of the Turner Proposal*. Special Report 227. Washington, DC.

USDOT (2012). *MMUCC Guideline – Model Minimum Uniform Crash Criteria*. 4<sup>th</sup> Edition. Available at <http://www.mmucc.us/> as of May 30, 2014.

USDOT (2004). Western Uniformity Scenario Analysis, Washington, DC, U.S. Department of Transportation. Available at <https://www.fhwa.dot.gov/policy/otps/truck/wusr/wusr.pdf> as of May 30, 2014.

Westerman, SJ, and D. Haigney. (2000). Individual differences in driver stress, error and violation. *Personality and Individual Differences*, pp. 981-998.

Woodrooffe, J., D. Anderson, et al. (2004). The Influence of Policy on Crash Rates of Long Combination Vehicles. 8th International Symposium on Heavy Vehicle Weights & Dimensions, Johannesburg, South Africa.

**APPENDIX A: REVISED DESK SCAN**

**TABLE OF CONTENTS**

**CHAPTER 1 – Introduction ..... 102**

1.1 Purpose ..... 102

1.2 Historical Perspective of Size and Weight Policy Related to Safety ..... 103

1.3 Review of Safety Literature Related to Analysis of Truck Size and Weight..... 104

1.3.1 Data Issues ..... 105

1.3.2 Studies Focused on Vehicle Stability and Control (Performance Characteristics).... 107

1.3.3 Studies of Crash Analysis of Configurations..... 110

**CHAPTER 2 – Responses to Specific Requests by NAS Panel..... 113**

2.1 Analysis Methods and Synthesis of State of Practice in Modeling Impacts ..... 113

2.2 Identify Data Needs and Evaluation/Critique Available Data Sources..... 115

2.2.1 Crash and Other Data Supporting Crash Analysis..... 115

2.2.2 Analysis of Vehicle Stability and Control ..... 116

2.2.3 Analysis of Inspection and Violations ..... 116

2.2.4 Concluding Comment ..... 116

2.3 An Assessment of the Needs for Future Research, Data Collection and Evaluation..... 117

2.3.1 Alternative 1: UMTRI Survey-based Approach ..... 117

2.3.2 Alternative 2: Case-Control Formulation ..... 118

2.3.3 Summary ..... 118

2.4 Synthesis of Quantitative Results of Past Studies..... 119

2.5 Additional Desk Scan Content ..... 120

2.5.1 Vehicle Stability and Control Analysis..... 125

2.5.2 Analysis of Inspection and Violations ..... 125

**CHAPTER 3 – Comparison of Results between 2014 CTSW Study and Previously  
Published Truck Size And Weight Studies..... 126**

**3.1 Purpose..... 126**

**3.2 Comparison of Safety Study Findings..... 126**

**CHAPTER 4 – Technical Linkage Between Desk Scan and Project Plans ..... 128**

4.1 Purpose ..... 128

4.2 Safety Analysis Linkages ..... 128

**CHAPTER 5 – References ..... 130**

**APPENDIX A – Summary of Additional Responses to NAS Peer Review Panel Issues... 134**

**APPENDIX B – Observational and Pilot Studies of Longer/Heavier Trucks ..... 135**

**APPENDIX C – International Experience ..... 138**

    C.1 Alberta LCV ..... 138

        C.1.1 General Provisions ..... 138

        C.1.2 Equipment Requirements ..... 139

        C.1.3 Operational Requirements..... 140

        C.1.4 Adverse Weather ..... 140

        C.1.5 Hours of Operation..... 141

        C.1.6 Exemptions for Vehicle Length ..... 141

    C.2 Ontario LCV Program ..... 143

        C.2.1 Carrier Qualifications ..... 145

        C.2.2 Driver Qualifications..... 145

        C.2.3 Route Conditions..... 146

    C.3 OECD Moving Freight in Better Trucks ..... 146

    C.4 Netherlands..... 148

        C.4.1 European Modular System ..... 150

    C.5 Sweden..... 151

## CHAPTER 1 – INTRODUCTION

### **1.1 Purpose**

This report presents a revised version of the Desk Scan (Subtask V.A.2) developed to support the Highway Safety and Truck Crash Comparative Analysis (Task V.A) of the 2014 *Comprehensive Truck Size and Weight Limits Study (2014 CTSW Study)*. This revised Desk Scan addresses the recommendations made by the National Academy of Science (NAS) Peer Review Panel concerning the originally submitted version of this scan.

The purpose of the revised Desk Scan is to:

- Reorganize and enhance the original Desk Scan; and
- Add any additional, relevant content that may have been identified since the submission of the original Desk Scan.

Specifically, the NAS Peer Review Panel recommended that the original Desk Scan be reorganized to address four issues:

- Survey of analysis methods and a synthesis of the state of the art in modeling impacts
- Identification of data needs and a critique of available data sources
- Assessment of the current state of understanding of the impacts and needs for future research, data collection and evaluation
- Synthesis of quantitative results of past studies including reasonable ranges of values for impact estimates.

The purpose of this task is to summarize important studies that have explored the safety of different truck and trailer configurations of potential relevance to the 2014 CTSW Study currently underway. This report responds to comments received from the NAS Peer Review Panel on Truck Size and Weight, which reviewed and commented on an earlier version of this desk scan. As a result, this revised scan is structured based upon the FHWA contract. As part of the safety task, the revisions are organized around 3 technical areas; crash analysis; analysis of vehicle stability and control and analysis of inspection and violation data. Content for the scan included reviews of sources recommended through public input and list of safety resources recommended by the NAS Peer Review Panel. All relevant references and sources are included in this scan. The revised scan also responds to additional comments from the NAS Peer Review concerning safety related to the 2014 CTSW project.

The response of the safety team may be somewhat different than the other CTSW teams because the team membership changed completely after the initial desk scan was submitted. Minor revisions and additions were added as part of the submission of the project plan, so the response to the more detailed NAS Peer Review comments resulted in re-writing and reorganizing major sections of the scan.

In particular, an emphasis on analysis methods and data supporting the safety analyses conducted by the team. As such, the prior original scan has been edited to reduce much of the original material, provided by another contractor, dealing with regulatory and policy issues beyond the analysis and assessment of safety. As a result, detailed discussions of regulatory frameworks in Canada, Australia and Europe have been substantially revised and are in Appendix B and C of this report for those interested.

### **1.2 Historical Perspective of Size and Weight Policy Related to Safety**

There have been a number of prior research studies addressing truck size and weight issues; they include:

- TRB study of the Turner Proposal (TRB, 1990b).
- Review of Truck Size and Weight Limits;
- The U.S. Department of Transportation (USDOT) Comprehensive Truck Size and Weight Study, 2000 (FHWA, 2000); and
- The Western Uniformity Scenario.

Former Federal Highway Administrator Francis Turner suggested a new approach to truck size and weight regulation in an address to the American Association of State Highway and Transportation Officials (AASHTO) in 1984. The Turner Proposal envisaged trucks with lower axle and axle group weights, on more axles than current vehicles, and with a greater allowable gross weight. AASHTO asked the Transportation Research Board to establish a committee to conduct a comprehensive study of the proposal, and advise states on its merits.

The committee designed a package of changes in size and weight limits, safety restrictions, and procedures pertaining to bridge deficiencies, routing, and enforcement as a means of implementing the Turner proposal (TRB, 1990b). The truck configurations considered by the study utilized a wide range of possible values for axle weights, length limits, and other vehicle characteristics to achieve the best performance in terms of productivity, pavement wear, bridge costs and safety.

A review of truck size and weight limits was initiated in the 1998 Transportation Equity Act for the 21st Century (TEA-21). It directed the Secretary of Transportation to request the Transportation Research Board (TRB) conduct a study of the regulation of weights, lengths and widths of commercial motor vehicles operating on Federal-aid highways to which Federal regulations apply, and to develop recommendations regarding any revisions to law and regulations that the Board determines appropriate (reference somewhere to 2000 study). Among the results of this study were that Federal truck size and weight regulations should facilitate safe and efficient freight transportation and interstate commerce, establish highway design parameters and help manage consumption of public infrastructure assets (FHWA, 2000).

The study recommended that Congress should create an independent public organization charged with observing and evaluating commercial motor vehicle performance and the effects of size and weight regulation, which the committee called the Commercial Traffic Effects Institute. Among other recommendations, the study suggested that safety requirements should be proposed by states, reviewed by the Commercial Traffic Effects Institute and approved by the Secretary.

The USDOT's Comprehensive Truck Size and Weight Study, 2000 (2000 CTSW) was not primarily focused on any policy initiative but more on development and testing of analytical tools to estimate potential diversion of traffic from one type of truck to another, or diversion between truck and rail, if truck size and weight limits were changed. Impacts of proposed size and weight changes considered to be most critical were: safety, productivity, infrastructure (pavements, bridges, and geometrics), traffic congestion, environment, and on railroads. Because safety was and continues to be a contentious issue in relation to increased truck size and weight limits, this study included an extensive review of past safety studies and developed a consensus of results. Therefore, the study used computer simulation tools to evaluate stability and control properties of different vehicle configurations at different weights and dimensions. The tools were intended to provide a measure of the relative safety compared to vehicles in widespread use.

The Western Uniformity Scenario was conducted at the request of the Western Governors' Association (USDOT, 2004). The study found several benefits from allowing more widespread use of LCVs. The benefits included a reduction in fuel consumption, emissions, and noise-related costs. The study included a comprehensive vehicle stability safety analysis using computer simulation and vehicle performance measures using the same methods as in the 2000 CTSW Study. The study recommended that, to the extent possible, the vehicles accepted would be at least as safe as vehicles on the road at the time and that the companies operating those vehicles should have excellent safety records.

The effect of large and heavy trucks on longitudinal roadside barriers was an issue raised during the 2014 CTSW Study by FHWA Subject Matter Experts (SMEs). Two specific references were reviewed: Gabauer, 2012 ND Knipling, et al., 2004). The data used in the Gabauer study, with the exception of LTCCS, did not contain sufficient details of LCVs to be of interest to the present study. The study provides some ideas of how to include barrier issues in future crash-related analyses for CTSW studies. The second reference conducted no analysis of crash, vehicle stability and control or inspection and violation data; the study focused on safety countermeasures for heavy truck crashes.

### **1.3 Review of Safety Literature Related to Analysis of Truck Size and Weight**

This section focuses on past research on the effect of truck size and weight on roadway safety in North America. There have been two recent surveys of research on truck size and weight issues, including safety (AASHTO 2009; Carson 2011). These surveys reviewed most recent significant research and drew conclusions that are broadly similar to each other. The reviews, particularly the work by Carson, extended beyond the safety of heavy trucks to include significant research on infrastructure, pavement, highway geometrics, enforcement and related issues. These surveys report the findings of a broad array of studies of different aspects of larger and heavier trucks. Rather than repeat the work of these two reviews, the focus in this review will be on data and methodology, how the available data constrains the types of research questions that can be addressed, and the different methodologies that have been employed to address those questions.

### 1.3.1 Data Issues

A consistent theme of heavy truck research on size and weight issues has been the limitations of crash and exposure data. Most crash data systems are inadequate to identify longer or heavier trucks. No state crash data system includes the operating weight of trucks (or other vehicles) at the time of the crash. Nor do most include lengths of either individual units or combination lengths. A handful of states include some information on the number of axles on trucks, which can be a surrogate to identify trucks designed to carry heavier loads. Most states can distinguish straight trucks from tractor-trailer combinations and single-trailer units from double (or triple) trailer combinations, but cannot identify trucks operating at heavier weights or longer lengths, where heavier weights are considered to be greater than the 80,000 lbs. (Scopatz 2001). Other issues with developing a good analytical model are the biases that exist in some of the data that are available. Since truck weight data are, to a large extent, collected at weigh stations, the available weight data are likely to be biased toward the legal-weight carriers since overweight trucks are more likely to avoid weigh stations, using alternate routes (Taylor *et al.*, 2000). One approach to address this bias is the use of Weigh-In-Motion (WIM) systems that unobtrusively collect vehicle count, weight and configuration data.

At the national level, the two primary Federal crash data sets are the Fatality Analysis Reporting System (FARS) and the General Estimates System (GES) files. FARS is a census file of all motor vehicles in fatal crashes, while GES is a nationally representative sample of police-reported crashes, so it includes both fatal and nonfatal crashes. Trucks are identified in each but details are lacking beyond basic configurations. Neither data set includes any data on weights or lengths nor even axle counts. (NCSA 2011; NHTSA 2011) The MCMIS (Motor Carrier Management Information Systems) includes crash, census, company, and inspection data. (Examples of some of the analysis done include those of Blower, 2004; Matteson, Blower, 2010; Matteson, 2005, available at: <http://141.213.232.243/handle/2027.42/3138>, <http://141.213.232.243/handle/2027.42/21606>, and <http://deepblue.lib.umich.edu/bitstream/handle/2027.42/65062/102670.pdf?sequence=1>.) Discussions with SMEs and within the safety team during analysis plan development indicated inconsistencies in the crash data within MCMIS (e.g. under-counting crashes; limited location information).

The Trucks Involved in Fatal Accidents (TIFA) crash data set from the University of Michigan Transportation Research Institute (UMTRI) is the only data set that includes detailed information about truck configuration that can address at least some of the gap. The data include power unit type, number of trailers, number of axles on each unit, and the types of connection between the units. For example, tractor-double trailer combinations are classified as using either A- or C-dollies or B-trains. Before 2005, TIFA also included the empty weights and lengths of each unit, cargo weight for each unit, and overall weight and length. At that time, TIFA had all the information needed to identify different truck configurations at the required level of detail. But TIFA data collection was stopped after the 2010 data year; hence, this resource is no longer available. In addition, TIFA was limited to fatal crashes only, and did not include exposure (mileage) information (Matteson, Pettis *et al.* 2007; Jarossi, Hershberger *et al.* 2012). Some believe that TIFA could be, in concept, an excellent supplement to broader more representative data sets such as state-level data.

Exposure data are equally, if not more problematic. The Federal Highway Administration (FHWA) *Highway Statistics* publication only distinguishes single unit trucks from combination vehicles, and provides registration and travel estimates by highway type and urban/rural (FHWA 2013). The Vehicle Inventory and Use Survey (VIUS) from the Bureau of Census used a survey of truck users to collect annual estimates of travel for different truck configurations, empty weight and typical gross weight, but the data did not disaggregate travel by road type. Moreover, the data series was discontinued in 2002 (Bureau of the Census 2002) (Campbell, Blower *et al.* 1996).

Other sources include state estimates from vehicle classification stations and weight-in-motion (WIM) stations. The vehicle classification stations classify vehicles by FHWA's 13-level classification. Trucks are classified as single-unit, one or multiple trailers, and by the number of axles. The WIM stations estimate gross weight. This information can be combined to develop estimates of truck travel for the FHWA truck classes and gross weight, but only for the locations where the stations are operating. This technique has been used in several recent studies (Abdel-Rahim, Berrio-Gonzales *et al.* 2006b; Montufar, Regehr *et al.* 2007; Regehr, Montufar *et al.* 2009). But there remains the problem of matching the VMT estimates derived from these sources to trucks in the crash data because of the lack of detailed configuration information in the crash data.

One older source of travel information is worth mentioning here despite its age, because it was the source of VMT data that was used in several of the influential studies that are discussed here. The National Truck Trip Information Survey (NTTIS) exposure database was compiled by the UMTRI. NTTIS was a survey complementary to the TIFA crash data set, and collected VMT data for configurations at the same level of detail as the TIFA crash data. The VMT data was collected for a sample of registered trucks by road type, time of day (day or night), and urban/rural. The combination of TIFA and NTTIS data allowed crash rates to be calculated by performance characteristics (Blower and Pettis 1988). NTTIS was operated only for one year (1987), and the TIFA data collection effort was discontinued as of the 2010 crash year.

There are specific crash-related factors for which either crash or exposure data will not exist. For example, while crash data include weather conditions, truck exposure data will not. A report by Rossetti and Johnsen (2011) focuses on the potential effect of climate change on commercial motor vehicle safety. The concern is developed in response to potential changes in climate that may pose an increase in crash risk to commercial motors carriers and other highway users.

Broadly speaking, there have been two approaches to evaluating the relationship of truck size and weight to safety. The first approach relies on identifying critical performance characteristics of heavier and longer trucks, such as rollover threshold, braking efficiency, and rearward amplification, and then comparing those parameters to the values for trucks in the existing fleet. The safety of proposed new configurations is then extrapolated from the existing fleet. The other thing to be noted about configurations is that it is not merely size or weight, but the interaction of the two. That is, a longer wheelbase may carry the same load as a truck with a shorter wheelbase, but the shorter wheelbase will create greater damage. That said, the longer wheelbase creates other safety related issues in terms of maneuvering and ability to see other road users.

Relationships between crashes and operating parameters have been estimated in one study (Fancher and Campbell, 1995). The second approach relies on observational studies of the



operations of trucks of interest in actual operations, insofar as they can be identified. The trucks are operated, often restricted to certain routes or road types, over a certain period of time and then the effect on safety is observed through analysis of crash frequencies and crash rates. Studies using both approaches are discussed.

### ***1.3.2 Studies Focused on Vehicle Stability and Control (Performance Characteristics)***

Two TRB reports are discussed first because they laid out the relevant handling and performance characteristics related to safety and provided a model for this approach. They are *Special Report 225: Truck Weight Limits: Issues and Options*, and *Special Report 227: New Trucks for Greater Productivity and Less Road Wear* (TRB 1990a; TRB 1990b). Special Report 225 was requested by the US Congress to assess proposals for changes in Federal weight limits, evaluating the impact on productivity, pavement, bridges, safety and operations, and enforcement. For the safety findings, the study largely relies on existing research and assesses the impact on safety in terms of how increases in size and weight would affect critical performance parameters including rollover threshold, rearward amplification, braking, steering sensitivity, low-speed offtracking and high-speed offtracking. Crash analysis used to evaluate the characteristics was based on crash rates calculated using TIFA and NTTIS data, because most of the performance measures can be estimated in those data. The study largely drew on work by Fancher *et al.*, and Campbell *et al.* (Campbell, Blower *et al.* 1988; Fancher, Blower *et al.* 1989).

The second TRB report, *New Trucks for Greater Productivity and Less Road Wear* (TRB 1990b), applied this basic methodology to estimate the safety and other effects of several specific configurations with longer trailers and heavier loads than currently permitted. These are the so-called “Turner Trucks”. The logic of Turner’s proposal was to permit higher GVWs, carried on more axles to reduce individual axle loads. The argument is that lighter axle loads would reduce pavement wear and higher payloads would require fewer trucks to carry the same amount of cargo.

Since the truck configurations under consideration are not found in crash data, their safety cannot be assessed directly and was instead inferred from their performance characteristics. This was done by, comparing them to existing truck configurations for which there are some crash experience, and estimating crash rates. The study projected that the 9-axle, two 33-foot trailer, combination would have slightly lower crash involvement rates than current 5-axle, 28-foot trailer double combinations because of better braking efficiency, higher rollover threshold, and lower rearward amplification. However, the study cautions that these findings assume that components such as brakes are not downsized to take advantage of the lower axle loadings. If the components were downsized, some of the advantages of the Turner configurations would be reduced. The study also noted that some operational conflicts, such as during merging, changing lanes, and clearing intersections, would be increased by the greater overall lengths and lower engine horsepower-to-GVW ratios.

Finally, the study cautions that the conclusions are based on performance characteristics derived from simulation and controlled testing rather than operational experience, that the safety inferences are based on extrapolation from the population of existing truck configurations, and that there is statistical uncertainty in the crash rates of truck configurations currently in use.

Harkey *et al.* considered the performance characteristics of different types of LCVs, including Rocky Mountain double trailer combinations, turnpike double trailer combinations, and triples, in relation to highway geometric design (Harkey, Council *et al.* 1996). The goal of the study was to project how current design practices might be affected by these characteristics. The measures included offtracking, stability (rollover, trailer sway, and rearward amplification), braking and stopping distance, and speed and acceleration. No explicit performance analyses were conducted.

At about the same time, Fancher and Campbell identified and assessed the primary handling and stability characteristics of heavy vehicles, which directly affect their ability to maneuver safely in traffic. The focus of the work was only on physical characteristics, though the authors noted that “differences in operating environment can overshadow the influence of vehicle characteristics” (Fancher and Campbell 1995).

The paper reviewed the experience of twin-tank trailers in Michigan as showing that heavier vehicles can be designed to provide safety performance equivalent to other trucks. The twin-tank configurations used in Michigan were evaluated and redesigned to improve their stability. The point is to include safety – in terms of handling and stability – as explicit goals of policy. “Simply adding weight to existing vehicles is a poor idea, but new vehicles that are designed to carry more weight can well be safer than less productive, current vehicles.”

The paper reviewed the following handling and stability characteristics: Offtracking in turns; rollover in turns related to radius of curvature and superelevation of the roadway; weight-to-power ratios to sustain speed on hills and merge safety; acceleration at intersections in relation to available sight-distance; braking in relation to available sight-distance; braking capacity on downgrades; and adequate sight-distance for passing. TIFA and NTTIS data were used to support the analysis.

### 1.3.2.1 Findings

- Rollover probability in a crash is inversely related to roll threshold, such that trucks with roll thresholds of about 0.4g are significantly more likely to rollover in a crash as trucks with roll thresholds of 0.6g.
- Rearward amplification, which is the ratio of the lateral acceleration of the last unit in a multi-unit combination to the lateral acceleration of the first unit, is directly related to rollover risk.
- Braking efficiency is defined as the ratio of maximum rate of deceleration achievable without wheel lockup, compared to the coefficient of road adhesion.
- Low-speed offtracking in principle is directly related to crash risk: as low-speed offtracking increases, crash rates would be expected to increase. However, it appears to have only a small effect on fatal crashes; it is more likely to show up in property damage crashes.
- Crash rates tend to increase with increases in GVW. The other characteristics discussed tend to be associated with changes in the rates of specific types of crashes, where the way

the crashes occur is related to the performance characteristic. For example, low roll threshold is associated with higher rates of rollover, but not with higher crash rates overall. Weight is different and is associated with higher crash rates overall. Only tractor-semitrailers were analyzed for the report and the authors caution that this result cannot be extended to different vehicle configurations because they may have been designed to different handling and stability levels. That is, they may have been designed for a heavier weight without degrading characteristics below the existing fleet.

USDOT's 2000 CTSW Study that followed shortly thereafter took a similar approach in analyzing safety, with the safety discussion largely focused on the effect of the usual vehicle characteristics. Given the lack of adequate and appropriate crash and exposure data, the analysis drew on the results of engineering tests of performance measures of the vehicle combinations. Qualitatively, the study reported that GVW, weight distribution, and the center of gravity height all had negative effects on static and dynamic vehicle stability, braking and offtracking. The number of units in a combination had a negative effect on dynamic stability, braking and high-speed offtracking, but positive effects on low-speed offtracking. The number of axles, similar to the Harkey *et al.* finding above, had positive effects on vehicle stability, braking, and low- and high-speed offtracking (FHWA, 2000).

The *Western Uniformity Scenario Analysis* was undertaken by the USDOT as the 2000 CTSW Study was being completed. The Western Governors' Association requested an analysis of the consequence of lifting the existing freeze on LCV sizes and weights and allowing harmonized limits across 13 Western states (i.e., Colorado, Idaho, Kansas, Montana, Nebraska, Nevada, North Dakota, Oklahoma, Oregon, South Dakota, Utah, Washington, and Wyoming). Weights for LCVs would be limited only by the Federal bridge formula and limits to axle weights, resulting in a maximum GVW of 129,000 lb. The study used the same methods as the 2000 CTSW Study and relied on the same studies and data.

The study analyzed the performance of 17 configurations, including STAA double trailer combinations (two 28-foot trailers), tractor with a 53-foot semitrailer, turnpike double trailer combinations (two 45- or 48-foot trailers), several types of Rocky Mountain double trailer combinations defined by different combinations of cargo body type and connection type (A- or B-train), A-train and C-train conventional triples (28-foot trailers), and a tank truck-trailer. Some of the vehicles were in current operation in the West and others would potentially be permitted. The work focused on handling and stability properties of the vehicles. The study found that most of the LCVs currently in use had roll thresholds as good as or better than STAA double trailer combinations, as did most of the LCV configurations proposed. In terms of rearward amplification all but one of the current LCVs had better values than the STAA double, as did all of the scenario vehicles, except triples with A-dollies, which had by far the highest value at 2.72. Using C-dollies, which eliminates two points of articulation reduced the rearward amplification value to 1.66. Load transfer ratio, which is a measure of load transferred laterally in transient evasive maneuvers, was worse for two configurations in current operations: STAA double trailer combinations and triples using A-dollies. All other configurations, both LCVs currently in use in the West and proposed scenario vehicles, had better load transfer ratios.

Only limited crash and exposure data analysis was undertaken, comparing crash rates for single-trailer versus multi-trailer trucks by road type. The study relied on FARS data and FHWA

estimates for travel, and so was unable to disaggregate different current or proposed LCV types. Although the data were unable to resolve any of the specific combination types, the authors emphasized the influence of road type—crash rates on non-limited access roads were estimated to be two to three times higher than limited access—and by extension operating environment.

### ***1.3.3 Studies of Crash Analysis of Configurations***

The following is a summary of truck crash analyses that included elements of truck configuration. Most do not consider LCVs, but are included as examples of methodologies that may be modified to include CTSW-type configurations.

Campbell *et al.* (1988) used the TIFA and NTTIS data to calculate crash rates for fatal accidents by truck configuration, operating environment (road type and time of day), and GCW. The study was not an evaluation of LCVs or an evaluation of trucks configured to operate beyond current limits, but instead to establish fatal crash rates for common configurations and to determine the effect of different dimensions of operating conditions. Estimated fatal crash rates vary by a factor of three to a factor of five depending on the type of road and time of day. In addition, it was noted that different truck configurations have different patterns of travel across road types, making simple comparisons of crash rates between configurations misleading. Adjusting rates to remove the influence of these different travel patterns, the study reported that fatal crash rates for double trailer combinations (primarily STAA double trailer combinations) are about 10% higher than tractor-semitrailers. Rates for bobtail tractors, however, were over twice as high, while straight trucks as a whole had adjusted fatal crash rates about 10% lower than tractor semitrailers. The study also noted an increase in fatal crash rates at higher GCWs. Because of data limitations, only gross weights up to 80,000 lb. were considered; the adjusted rate for the 65-80,000 lb. GCW group was about 40% higher than the 50-65,000 lb. GCW group. This implies that van tractor-semitrailers loaded to 65-80,000 lb. would have a 1.42 times higher rate than all tractor-semitrailers *if* they had the same distribution of travel (Campbell, Blower *et al.* 1988).

Blower *et al.* (1993) used crash and VMT data to develop a log-linear model to predict crash rates using truck configuration, road type, time of day, and urban/rural location as predictor variables. Crash data from Michigan were used, along with VMT data from a survey of truck-tractor operations. In the statistical model, there was no statistically significant difference in crash rates between tractor-semitrailers and double trailer combinations. The type of road had the largest effect on crash rates, with non-limited access roads having crash rates 6.8 times higher than limited access. Crash rates for double trailer combinations were about 10% higher than tractor semitrailers, but the difference was not statistically significant. GVW was not part of the data, so the effect of weight was not examined (Blower, Campbell *et al.* 1993).

Using a case/control methodology, Braver *et al.* compared the crash risk of tractor semitrailers and double trailer combinations in Indiana. Cases were crash-involved tractor semitrailers and double trailer combinations and the controls were tractor combinations that passed the case crash sites one to four weeks after the crashes, at the same time and on the same day of the week. Both cases and controls were limited to interstate highway locations. LCVs were not distinguished in the crash population, but the authors state that most double trailer combinations were likely to be STAA double trailer combinations. The study found no difference in crash risk between tractor

semitrailers and double trailer combinations. However, drivers of double trailer combinations in the crash population on average were older than tractor semitrailers drivers, and double trailer combinations tended to be operated in larger fleets. Data on drivers and companies was not collected for the controls so the effect of these potentially confounding factors could not be determined. The study also found higher crash risk for double trailer combinations on ice and snow, which may be related to handling properties (Braver, Zador *et al.* 1997).

Jovanis *et al.* used fleet data to compare crash rates for tractor semitrailers and double trailer combinations. This study is one of the few that used operational data from fleets, which has the advantage of controlling for differences in fleet operations. The study used randomly selected origin-destination terminal pairs for a national less-than-truckload (LTL) operation. Both tractor semitrailers and double trailer combinations operated over the same roads at approximately the same times, controlling for road type, though the road types were all ones that had been approved for double trailer combinations operations. The study reported that accident rates for double trailer combinations were somewhat lower than tractor semitrailers on every road type and that the differences, though small in some cases, were statistically significant (Jovanis, Chang *et al.* 1989).

Forkenbrock and Hanley compared crash conditions for single and multi-trailer trucks and concluded that multi-trailer truck crashes were more likely to occur on high speed roads than tractor semitrailers, more likely to involve two or more other vehicles and more likely to occur in conditions of darkness and on low friction roads, than single-trailer truck crashes. The analysis was performed using UMTRI's TIFA fatal crash data (Forkenbrock and Hanley 2003).

Hanley and Forkenbrock also developed a model of the effect of LCV length on the safety of other vehicles passing LCVs on two-lane highways. Policy and economic factors may direct LCVs to interstate-quality roads, but there will be a need for "reasonable access" in order to use the interstates. This will require some travel on lesser-quality roads, likely including two-lane highways. Hanley developed stochastic (probabilistic) models of passing that account for differences in performance between LCVs (impeding vehicle) and light vehicles (overtaking vehicle); driver aggressiveness; traffic volume and spacing of oncoming vehicles, lengths of the impeding vehicles, and speeds of the impeding vehicles. They found that as impeding vehicle length increases, odds of failure to pass increase. Odds of failing to pass a 120-foot long LCV are 2-6 times a 65-foot long truck. (Hanley and Forkenbrock 2005)

Lemp, *et al.* (2011) identified factors contributing to crash severity in large truck crashes using the Large Truck Crash Causation (LTCCS) and GES crash data, using the Bureau of Census's Vehicle Inventory and Use Survey (VIUS) to measure exposure. The LTCCS data were used to develop statistical models of the factors increasing crash severity. Crashes were more likely to include a fatality in dark or low-light conditions and when the roadway was snowy or icy. The number of trailers was directly related to the probability of a fatality (more trailers increases the chance of a fatality in a crash), but somewhat paradoxically overall truck length and higher gross vehicle weight rating were associated with *lower* probability of fatality. This result is interpreted as meaning single-trailer trucks have a lower probability of fatality, bobtail tractors have the highest, and single unit trucks and two-trailer LCVs and non-LCVs are in between. The authors caution that "[i]f truck length and/or GVWR increase past the levels common in the LTCCS sample, the model's estimates may not be valid." Thus on a per mile basis, estimated crash costs

are about the same in these data, for tractor-semitrailers and double trailer combinations (Lemp, Kockelman *et al.* 2011). While findings suggest that fatality likelihood for two-trailer LCVs is higher than that of single-trailer non-LCVs and other trucks, controlling for exposure risk suggests that total crash costs of LCVs are lower (per vehicle-mile traveled) than those of other trucks. Because this study primarily focused on analysis of crash severity, given a crash, it is not considered for more detail comparisons later in the scan.

## CHAPTER 2 – RESPONSES TO SPECIFIC REQUESTS BY NAS PANEL

Based on the more general review described in the previous sections, this section contains responses to specific requests made by the NAS Peer Review Panel.

### **2.1 Analysis Methods and Synthesis of State of Practice in Modeling Impacts**

*Blower, D., K.L. Campbell and P.E. Green (1993), Accident rates for Heavy Truck-Tractors in Michigan, Accident Analysis and Prevention, 25(3), 307-321*

This study used crash data from the state of Michigan and exposure data collected through a targeted survey. Both crash and surveys were for Michigan-registered tractors only. Factors considered (in addition to three truck types) were road type, time of day, area type (rural urban) and crash severity. The method was also applied to national-level crash and exposure data (Campbell, Blower, Gattis, and Wolfe 1988).

Interestingly, a footnote in the paper indicates that additional information not used in the paper included weights and lengths of all units, cargo body type, cargo weight at every point along the route, driver age and company type. So the method has the potential to overcome some of the major challenges posed over the years in size and weight studies: measurement of weights of vehicles in both the crash and exposure database. In a contemporary setting, it is possible that at least some of the data may be obtained from GPS-type devices, reducing the cost of data collection.

A log-linear model formulation using an underlying Poisson distribution was used to model the crash frequency with an assumed coefficient of 1.0 used for the exposure data (i.e. vehicle miles) to produce an effective crash rate. While more contemporary methods assume an underlying negative binomial distribution, the paper is among the earliest to assume a count distribution of the modeling of crash frequency.

Differences in the crash rates between single and double trailer combinations were not found to be statistically different; bobtails had a significantly higher crash rate than either single or double trailer truck-tractors.

The study is important because it demonstrates a novel method for explicitly linking state-level crash and exposure data using tractor registrations. A similar study was also completed using national-scale tractor information. The ability to integrate targeted crashes and match them to randomly obtained exposure (including vehicle and driver attributes) is a potentially powerful capability that has not been utilized since this research was concluded. There are some similarities between this method and the basic case-control method to be described in another reference.

*Jovanis, P., et al., (1989). "Comparison of Accident Rates for Two Truck Configurations." Transportation Research Record 1249*

The study used matched pairs of roads in which both double trailer combinations (twins) and single combination vehicles were operated. All crashes experienced by a single firm operating less-than-truckload operations over regular routes were used in the analysis; not just DOT-reportable crashes. Double trailer combinations were found to have significantly lower crash

rates than tractor semitrailers, though the differences were small. The precision obtained using company data allowed a tight comparison of both vehicle types operating over the same routes. The tradeoff is the limitation of broader generality. It is unlikely that this method can be applied to many LCV analyses, particularly triples comparisons, because where triples are allowed, firms have indicated that they dominate vehicle usage. In other words, one cannot conduct a paired-comparison test for triples because the second vehicle type, double trailer combinations, would have very low exposure on the same routes and thus very low crash frequency. This was borne out in the safety team's interactions with carriers on this study.

*Braver, E. R., P. L. Zador, et al. (1997) "Tractor-trailer crashes in Indiana: A case-control study of the role of truck configuration." Accident Analysis & Prevention 29(1): 79-96*

A case-control formulation is used in which the cases are crashes involving single or double combinations and controls are a random sample of similar vehicles passing the crash site at the same time and day of the week. Data could not be disaggregated to the level of LCVs. The findings were that the crash odds of the two configurations were undistinguishable. The authors point out that older, more experienced drivers are more likely to operate double trailer combinations, likely contributing to a reduction in their crash rates.

Another study (Stein and Jones, 1988) also sought to compare the crash rates of alternative configurations using the case-control formulation. Unfortunately, serious questions were raised about the measurement of exposure, invalidating the study, despite its publication in a peer-reviewed journal. A follow-up study (Jones and Stein, 1989) linked crash rates and vehicle defects, further illustrating the utility of the case-control method.

The case-control method is widely used in epidemiology and has been used in several road safety analyses of which these are examples. While this study was unable to identify LCVs, there is no reason why a study cannot be designed with LCV safety as a goal. One of the advantages of the case-control method is its flexibility and ability to identify rare crash events (cases), which are then compared to non-crash events as controls.

*Regehr, J. D., J. Montufar, et al. (2009). "Safety performance of longer combination vehicles relative to other articulated trucks." Canadian Journal of Civil Engineering 36(1): 10*

The study developed exposure measures using vehicle count data on roadway segments, distributions of gross weight from WIM stations, a survey of vehicle length on one stretch of highway for one year, vehicle classification counts at selected stations, and a roadside survey of fleet mix data. These data were used to develop estimates of VKT (vehicle kilometers of travel) for routes on which LCVs were permitted to operate. Configurations considered in the analysis include straight trucks, tractor-semitrailers, "legal-length" double trailer combinations (STAA double trailer combinations), Rocky Mountain double trailer combinations, turnpike double trailer combinations, and triples. Alberta has among the most stringent driver, carrier, and vehicle regulations on LCVs in the CANAMEX corridor (Canada, US and Mexico). The conclusion stated, "The relatively superior safety performance of LCVs in Alberta may result in part from the stringent conditions placed on their operations through the design and enforcement of special permits. Principal along these is the requirement for experienced, specially-qualified driver for LCV movements" (Regehr, Montufar *et al.* 2009). LCVs had lower crash rates than other trucks, but this finding cannot be extrapolated to U.S. conditions. As a result of the differences in operating requirements and conditions, the results of this study are not compared to U.S.-based research.



*Abdel-Rahim, A., S. G. Berrio-Gonzales, et al., (2006a), Classification of Longer Combination Vehicles Using Weigh-in-Motion Data, Final Report Part A, University of Idaho. , National Institute for Advanced Transportation Technology*

*Abdel-Rahim, A., S. G. Berrio-Gonzales, et al., (2006b). Longer Combinations Vehicles: A Comparative Crash Rate Analysis, Final Report Part B, University of Idaho. , National Institute for Advanced Transportation Technology*

These reports were part of a coordinated study. The first report describes the method for integrating Weigh-in-Motion (WIM) data with VMT counts. Since it involves data modeling for exposure, it is not reviewed here. The crash analysis is similar to what was attempted in the 2014 CTSW state –level crash data are used to compare different vehicle configurations. Conclusions could only be reached for double trailer combinations and single combinations due to a lack of sufficient crash data for LCVs. No differences were found between the two configurations.

## **2.2 Identify Data Needs and Evaluation/Critique Available Data Sources**

A conclusion of many safety studies LCVs is that crash-based studies of truck size and weight using U.S. data are very difficult to conduct successfully. Vehicle stability and control analysis is not subject to the same constraints as crash analysis. There have been several successful tests using this technique, so there are no urgent data needs in this area. Analysis of violation and enforcement data are constrained by a variety of data difficulties, so the existing databases are further discussed in this section of the desk scan. Much of the discussion in this section on crash analysis is drawn from material prepared by Dr. Forrest Council as part of the safety project team technical report.

### ***2.2.1 Crash and Other Data Supporting Crash Analysis***

Safety components of truck size and weight studies are likely to continue to have difficulties if the studies are based on the primary data sources in existence today – state crash files, state roadway inventory data, state AADT data and additional data on VMT for specific truck configurations. Crash data supplied by fleets were little better; as discussed in the scan the primary variable of interest – the weight of the LCV configuration involved in the crash, is consistently unavailable. WIM data was insufficient to use for detailed route-level travel needed for enhanced crash analysis using contemporary methods.

The issues found in this study are not new and will continue to be encountered unless changes are made in these primary databases. While existing roadway inventory and AADT data will likely be sufficient for use in future studies, major improvements are needed in crash data and VMT data for specific truck configurations.

Crash data need to include precise information about the configuration and weight of trucks involved in crashes. It is difficult to develop a recommendation in this area that provides the level of detail necessary and can be implemented using existing crash data collection methods. While it may not be possible to have the investigating police officer report the actual GVW on crash report forms since the truck operator does not possess that information, it should be possible, as a minimum, for the investigating officer to accurately report a count of trailers, a count of total axles, and the length of each trailer for combination vehicles involved in crashes.

Most state crash forms now include a count of trailers, but far fewer have an axle count variable and almost none have information on trailer length. Consideration should also be given to including an axle count variable and three trailer length variables in the next edition of the Model Minimum Uniform Crash Criteria guidance document (MMUCC, 2012). Another option is to enhance MCMIS data to better and more consistently record the date, time and location of reported crashes. FMCSA, or a contractor, could then follow-up with the carrier to seek information about combination weight.

The single source of state and national truck VMT information for the specific configurations of interest in this 2014 CTSW Study is the WIM data described earlier. The number of current WIM data collection points is so limited that the needed VMT estimates could only be provided at the state functional class level. Even the VMT estimates for rural and urban Interstates for individual states were often based on a very limited number of WIM stations within each roadway classifications. In addition, they could not be used to estimate VMT for a specific configuration (e.g., heavy triples) on a given route. The ability to extrapolate WIM estimates to specific routes would be very important in future attempts to model target truck crashes on non-Interstate roads or to better model truck crashes on Interstate routes such that the effect of AADT changes on truck crashes per mile driven can be more accurately defined. Consideration should be given to increasing the number of WIM collection points.

### ***2.2.2 Analysis of Vehicle Stability and Control***

There are no data-related recommendations in this safety technical area. Data are generated within the simulation models so they are collected within a particular model. Modeling and analysis using vehicle simulation are and have been accepted with little discussion or critique.

### ***2.2.3 Analysis of Inspection and Violations***

The data used to support the inspection and violations analysis included the selection of the gross vehicle weight variable from the MCMIS database. Discussions with FMCSA indicated that this variable is not always available in the file as a measured weight, but that no better variable exists in MCMIS for description of combination vehicle weight. Mechanisms to improve accurate completion of the variable should include use of weights from scales wherever possible and, if not, assembly of data from on-board the truck to provide an estimate. Additional training of field personnel is likely to be needed to implement this concept within the existing data collection schemes.

### ***2.2.4 Concluding Comment***

The above changes would not need to be nationwide. These changes could be limited to states that are allowing operation of the above-limit configurations, and more specifically, to the states which have the highest current VMTs for the configurations of interest (e.g., target axle count and WIM changes to states with the highest use of alternative configuration trucks). Without enhancements to existing safety-related data systems, future studies will continue to experience difficulties in quantifying the safety implications of alternative truck size and weight policies.

### **2.3 An Assessment of the Needs for Future Research, Data Collection and Evaluation**

The area that created the greatest challenge in conducting the safety analysis for the 2014 CTSW Study was the lack of relevant data: crash data and comparable or corresponding travel exposure data. Considering road safety management as a whole, there has been consistent and strong emphasis on providing quality crash data, with complete reporting of data elements, accurately obtained in the field. There has been no comparable effort to improve the quality of truck weight and configuration information within safety-related databases. This problem is not under-reporting of crashes, but a lack of detail about crashes that can be used to connect outcomes to CTSW-type configurations, including weight.

Over the last 10 or more years, there have been tremendous advances in road safety analysis methods; particularly those targeted to the management of road infrastructure investments (e.g. AASHTO, Highway Safety Manual, 2010). Millions of dollars were spent to improve the methods used to identify safety problems, evaluate potential countermeasures and build a scientific basis for future safety investments by properly evaluating the effectiveness of the actions.

In reading the truck size and weight safety literature, there is no comparable comprehensive development of an integrated analysis framework specifically addressing all the nuances of truck size and weight. As a result, needed data are missing, the most important of which is the weight of vehicles involved in crashes. In virtually every study attempting to address the safety of longer and heavier vehicles, there is a recommendation to provide better crash data, particularly including the weight of involved trucks. It is fair to say that there has been no progress in this regard, despite the literature that includes two TRB policy studies (Special Reports 225 and 267 dating back to 1990). So while the road safety management community has been systematically organizing both data and analysis methods to address current and future road safety needs, the truck size and weight research effort has been relatively ineffective.

#### ***2.3.1 Alternative 1: UMTRI Survey-based Approach***

Interestingly, researchers at UMTRI broke new ground in their state and national scale studies using TIFA and survey-based exposure (e.g. the national Truck Trip Information Survey or NTTIS) in a series of papers and reports (e.g. Campbell, et al., 1988; Blower et al., 1993). They had to undertake a laborious process for exposure data collection involving telephone contact and much manual coding. Now the basic trip-based information of origin, destination, time of travel, distance and others (perhaps weight) are available through on-board GPS units designed for trucks. Even if these are not available, it may be feasible to attach non-company GPS to track some CTSW configuration travel. One could use the basic framework developed and tested by UMTRI using fatality data and seek to apply it using new technology to a broader set of crashes. There are many details to be discussed, but such a system operating over multiple years has the potential to provide adequate exposure data at a high level of precision, while details are decided about the crash data. This combination of targeted crash data and survey/GPS-based exposure data over multiple years has the potential to address many of the fundamental crash analysis problems in CTSW. In fact, such a system could obviate many of the data-related difficulties outlined in response to Task 2.1 b. The idea is to plan ahead, working proactively with carriers

and state DOTs as back up, over multiple years, not relying on retrospective crash and exposure data acquisition.

### ***2.3.2 Alternative 2: Case-Control Formulation***

There is another alternative to the computation of simple crash rates: structure an analysis plan that utilizes a case-control framework. This technique is used extensively in epidemiological studies and has been used increasingly in road safety. Several studies by IIHS used case-control applied to large trucks (Braver, et al., 1997; Stein and Jones, 1988; Jones and Stein, 1989). Truck driver fatigue has been studied using the method for over 20 years (e.g. Lin et al., 1993; Kaneko and Jovanis, 1992). More recently there have been studies applying the method to studies of the effectiveness of road safety countermeasures (e.g. Jovanis and Gross, 2007; Gross et al., 2009).

One advantage of this method is that it works well when the event of interest is unusually scarce (even among scarce crashes themselves). The driver fatigue research allowed the research team to assemble crash data (the cases) from firms and then use them to identify controls among non-crash trips. A similar approach can be used here: crashes involving LCVs can be the cases; other non-LCV travel can be the controls. Obviously more detail is needed; this approach was considered in the current study but abandoned because it did not fit well with the computation of crash rates used in the analysis. Case-control methods provide a measure of the relative safety of one entity compared to another; they cannot provide an absolute level of crash risk. What would be helpful is to start from scratch and develop a data collection structure that removes constraints and explores a range of possibilities.

### ***2.3.3 Summary***

A longer-term future-looking perspective argues that it is not enough to say we need better crash data and better exposure data that include samples of exposure from the configurations of interest. There is a need for a complete fresh look at the safety analysis issues in a way that takes advantage of the many methods developed in the last 10 years along with new technologies for data collection such as GPS and other on-board devices. An essential element of such a perspective is to not wait until 2-3 years before the next report is due to start to look for data. There is a need to begin carefully framing the safety data needs, and verify that a collection system is in place to assemble the needed data over a 5-8 year time period.

In studies of the safety implications of truck size and weight we need analysis methods that yield outputs that are responsive to persistent truck size and weight challenges. Among these are the questions about the safety consequences of increased construction brought about by the need to alter the road infrastructure (including bridges, pavements and road geometric elements) in response to truck weight and configuration changes. An increase in construction zone frequency was a topic raised in the TRB Panel Report and in our discussions with the panel. It could not be addressed in the current framework but is important enough to be included in future CTSW planning. Barrier implications have also been consistently raised; weather-related effects are another issue being studied in other safety and operational contexts but for which there are few studies in the truck literature. Each of these issues should be considered as an element of a more comprehensive safety analysis program, well in advance of the next Congressional mandate.

**2.4 Synthesis of Quantitative Results of Past Studies**

**Table 1** synthesizes the results of previous studies. The quantitative comparisons are made, but all involve double combinations of some types to single combinations of some types. In most cases the researchers were unable to separate what type of double was being used and the number of axles on the single as well. The Jovanis research showed double trailer combinations had lower crash rates than tractor semitrailers, while the Campbell team found the opposite. The remaining studies were unable to find a difference between these basic configurations. The results in this table clearly support the recommendations for alternative data collection plans leading to new data analysis designs.

**Table 1: Synthesis of Previous Studies**

| <b>Study</b>             | <b>Crash Data Source</b>   | <b>Exposure Source</b>  | <b>Summary</b>   | <b>Comments</b>   |
|--------------------------|----------------------------|---|--|---|
| Jovanis, et al., 1989*   | Fleet records; all crashes | Fleet dispatches for routes with both twins and 3-S2 operations | Double trailer combinations had lower crash rates than tractor semitrailers on matched pairs of roads                            | Data from one carrier; all crashes  |
| Campbell et al., 1988**  | TIFA (1980-84)             | NTTIS (1985)  | Single combinations higher fatal crash rate on urban interstates; multitrailer on rural interstates; multitrailer higher overall | From Western Uniformity Study Table VII – 7, Page VII – 17                |
| Abdel-Rahim et al., 2013 | Utah (1999-2004)           | FHWA and WIM  | No difference found in comparisons of single and double combinations; limited sample size of LCVs                                | Only computed crash rate per year all facilities; no route type breakdown |
|                          | Idaho (2003-05)            | FHWA and WIM  | No difference found in comparisons of single and double combinations; limited sample size of LCVs                                | Only computed crash rate per year all facilities; no route type breakdown |
| Western Uniformity       | 13 Western Uniformity      | FHWA  | Unable to differentiate  | Used approach roughly similar to  |

| Study                  | Crash Data Source          | Exposure Source | Summary   | Comments   |
|------------------------|----------------------------|-----------------|---|--|
| Scenario Analysis 2005 | State crash data (1995-99) |                 | involvement rates of single and double combinations | 2014 CTSW Study but without detailed attempt at scenario comparisons |

\* Include all crashes for firm, not just DOT reportable

\*\* Computed fatal involvement rates per 100 million vehicle miles

### **2.5 Additional Desk Scan Content**

The safety team has reviewed the suggested data sources supplied by USDOT SMEs and other reviewers; input from those attending outreach efforts related to the 2014 CTSW Study program were also reviewed. Finally, fresh literature searches were conducted to identify new methodologies.

*Sowards, K., E. Eastman, J. Matthews and E. Pennington, (2013), "An Analysis of Truck Size and Weight: Phase I – Safety," Multimodal Transportation & Infrastructure Consortium, Marshall University*

The authors use fatal crash data from 2005-09 contained in the Trucks Involved in Fatal Accidents (TIFA) data set along with exposure data (vehicle miles traveled or VMT) from the Federal Highway Administration (FHWA). Crash rates are computed and compared for multi-trailer and single-trailer truck configurations. No substantive description is provided of the method used to calculate crash rates. Multi-trailer rates include the many versions of double trailer combinations, combined. The authors state in several places that they cannot assess weight-related safety effects because they are not available in TIFA. They do calculate and compare fatal crash rates of single and double trailer trucks and find double trailer combinations have an 11% higher fatal crash involvement rate. There are several places in the executive summary and the text where the writing style seems less than objective and scientific.

The authors find that tractor semitrailers with 6 axles have a fatal crash rate that is 867% higher than for all single trailer trucks. This finding is difficult to believe, as such poor safety performance would likely result in much lower usage by firms and drivers. Additional shortcomings of this study were identified in a review of the research conducted by Dan Blower of UMTRI (see next review).

*Blower, D, Evaluation of "An Analysis of Truck Size and Weight: Phase I – Safety," from the Multimodal Transportation & Infrastructure Consortium, undated.*

Dr. Dan Blower conducted an independent (i.e. non-UMTRI sponsored) review of the report by Sowards. This was a very detailed review as Blower had access to and was very familiar with the TIFA data used for crash analysis and was familiar with the methods applied by Sowards in the crash analysis. Blower conducted several analyses including trying to replicate data contained in several of the tables in the Sowers report. Blower was unable to replicate the data commenting that the most likely reason was confusion on the part of the Sowers team concerning the use of crash and vehicle involvement in a crash. The errors include misleading and incorrect table headings and miscounting of fatalities. As a result, Blower concludes that the study has numerous errors sufficient to make it unreliable as a source of crash rate information. As a result,

this Desk Scan does not use the results of the Sowers study in our comparisons of crash rates in Chapter 3.

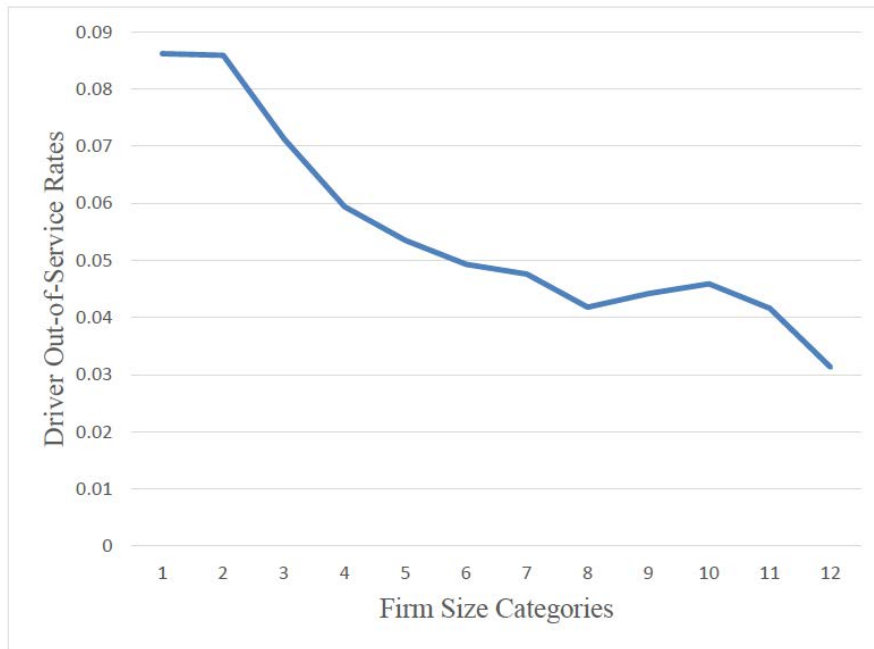
*Cantor, D.E., Ethan Osborn, Prabhjot Singh (2014), A Firm Size and Safety Performance Profile of the U.S. Motor Carrier Industry, Institute for Transportation, Iowa State University, Ames, Iowa.*

The purpose of this study was to present a profile of the relationship between firm size and safety performance for firms in the U.S. motor carrier industry. The study uses data from MCMIS and CSA databases obtained from Volpe Transportation Center for 2010. The data include information collected from the following comprehensive data sets: (1) commercial vehicle crash data, reported by states to FMCSA; (2) data collected from individual compliance reviews; (3) data from roadside inspections including violations; (4) data from closed enforcement cases; and (5) MCMIS Census File data on individual carriers, including their type of operations and fleet size.

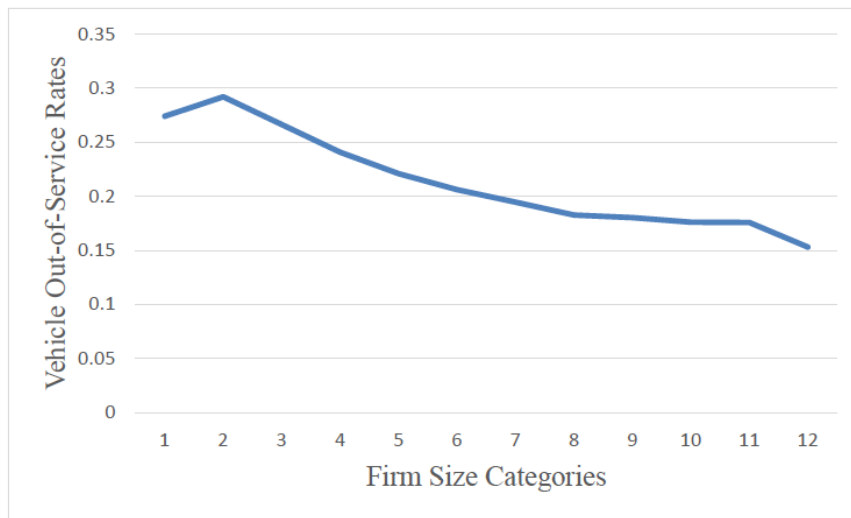
The study is interesting as a methodology, but does not differentiate findings by vehicle configuration or weight. It also does not attempt to use more contemporary safety performance analysis methods (e.g. AASHTO, Highway Safety Manual, 2010). The study treats the dependent variables as if they are continuous while the basic crash data are counts.

Using simple computed rates (defined as number of violations divided by number of inspections) the study shows that both driver and vehicle out-of-service rates decline with firm size (firm size defined as number of power units) in **Figure 1**. This is illustrated in the figures below, using the figure number from the report. It should be noted that there is a correlation between firm size and the number of power units. Therefore the development of graphs, such as in the figures below, adjust for scale of operations twice: both in the vertical and horizontal axes. Contemporary safety methods use frequency on the vertical scale and use as a basic predictor the exposure to risk on the horizontal scale (AASHTO, Highway Safety Manual, 2010).

**Figure 1: Firm Size and Driver Out-of-Service Rates**



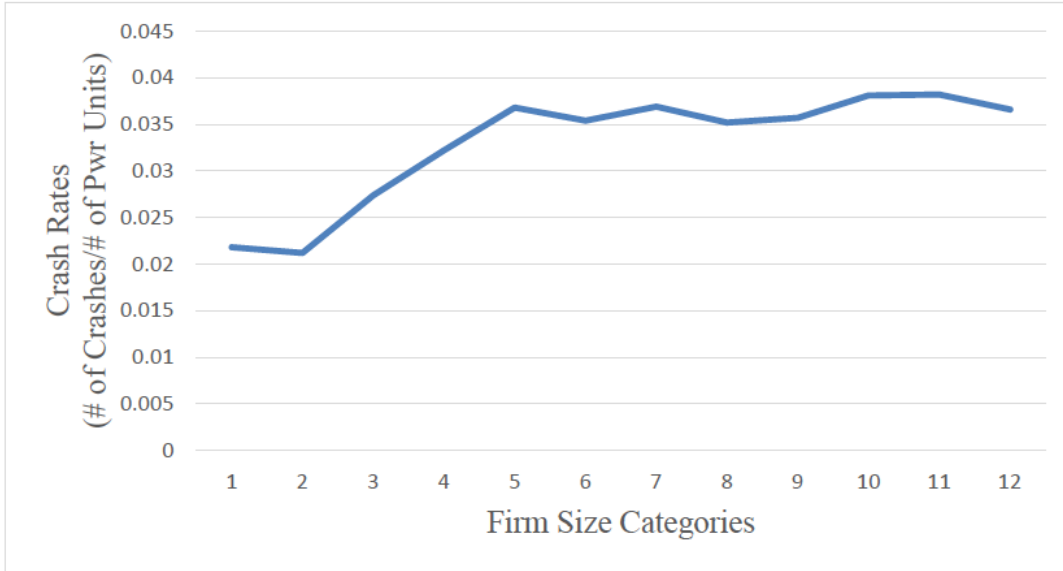
**Figure 2: Firm Size and Vehicle Out-of-Service Rates**



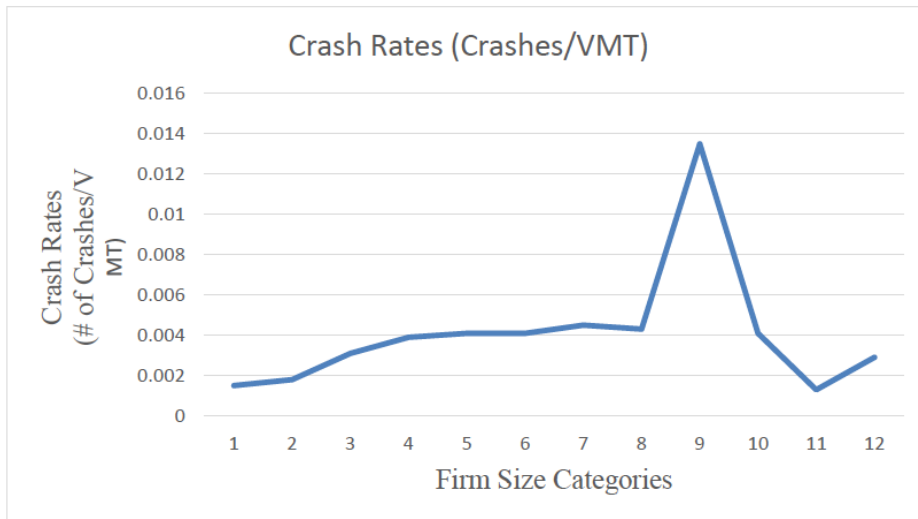


Additional analyses include crash rates, computed as crashes per power unit and per annual vehicle miles travelled. Both relationships show an upward trend, though the second has a peculiar peak for firm size 9 (see figures labeled **Figure 3 and 4** following).

**Figure 3: Firm Size and Crash Rates by Power Units**

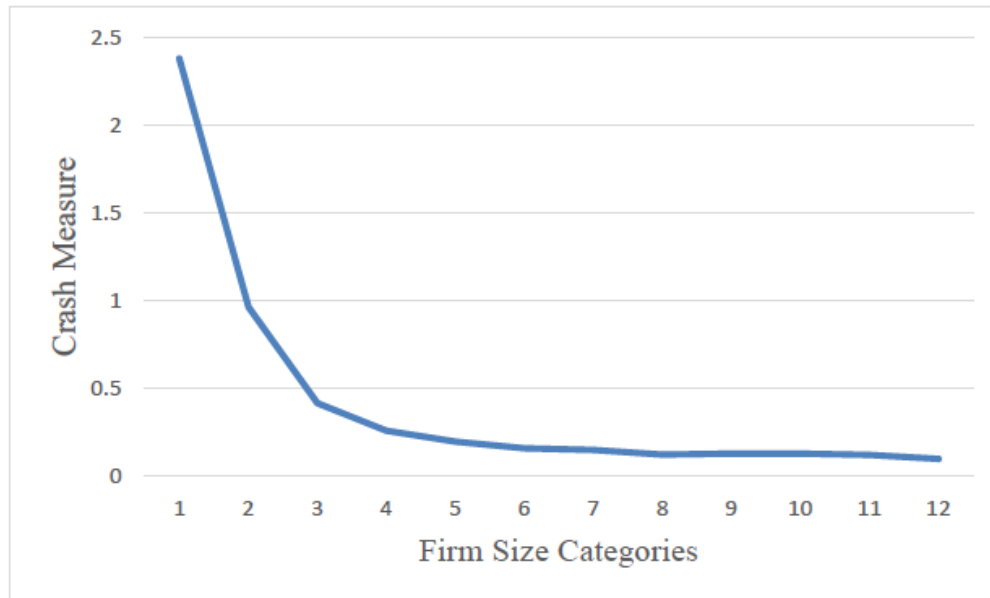


**Figure 4: Firm Size and Crash Rates by Annual VMT**



Additional crash-related information is obtained from the FMCSA BASIC program, and shows a trend of a *decreasing* crash indicator with firm size (see figure labeled **Figure 5** below). This is the opposite of the findings from crash data directly. The authors leave an explanation of the difference to future research.

**Figure 5: Firm Size and Crash Measure**



While there are inconsistencies and methodological questions about the study, it is of interest because of its use of existing FMCSA databases. There are also implications for Inspection and Violations analysis joined with the crash analysis.

*Segev, Eran; Meltzer, Neil, (2015), FMCSA Safety Program Effectiveness Measurement: Carrier Intervention Effectiveness Model, Version 1.0, Volpe Transportation Systems Center.*

The Federal Motor Carrier Safety Administration (FMCSA), in cooperation with the John A. Volpe National Transportation Systems Center (Volpe), developed a quantitative model to measure the effectiveness of motor carrier interventions in terms of estimated crashes avoided, injuries prevented, and lives saved. The model is known as the Carrier Intervention Effectiveness Model (CIEM).

As described in the report, the model computes carrier crash rates, defined as crashes per carrier power unit (PU), for carriers receiving interventions, distinguishing between crash rates for defined periods prior to and following the interventions. Power units are used as the unit of exposure and a control group is used to adjust for exogenous changes in factors influencing crashes and other dependent variables. Carriers are further differentiated by size of operation.

While the model is focused on enforcement interventions and their estimated effectiveness, it illustrates a new approach to the problem using crash data that includes a control group of carriers that did not receive interventions. Method is to be used on an annual basis.

The model does not focus on or identify large trucks or trucks by weight but shows an interest in more in-depth evaluation methods by FMCSA. The report uses a number of FMCSA data sources to derive a relationship between carrier interventions and changes in crashes. The crash frequency changes are in turn used to estimate injuries prevented and lives saved. The report mentions that the motivation is in response to internal U.S. government requirements for program evaluation, not necessarily improved road safety.

### **2.5.1 Vehicle Stability and Control Analysis**

*Elsasser, D., and F. S. Barickman, (2013), Tractor Semitrailer Stability Objective Performance Test Research - Yaw Stability, NHTSA, East Liberty Ohio*

A series of test track maneuvers were developed and implemented to represent lane-change, obstacle avoidance, and negotiating-a-curve crash scenarios. The goal was to use the tests to support a program of testing heavy-vehicle stability control systems. While not directly related to the use of vehicle simulation tests of particular heavy-vehicle configurations, the report provides additional background on USDOT programs in the area.

### **2.5.2 Analysis of Inspection and Violations**

*Hyeonshic S, S Bapna, R Buddharaju, (2014), Maryland Motor Carrier Program Performance Enhancement Research Report, Morgan State University, for Maryland State Highway Administration*

This report examines the effectiveness of the roadside inspection program in terms of the allocation of the limited resources using Research Reporting as a metric for the change in the number of truck violations over the years. The authors find that violations per inspection are dropping and conclude that the Maryland program is effective.

*Karim, M. R., A. S. Abdullah, H. Yamanaka, A. Sharizli, and R. Ramli, (2013), Degree of vehicle overloading and its implication on road safety in developing countries, Civil and Environmental Research, Vol.3, No.12*

The main purpose of this study is to understand and establish the extent to which vehicle overloading is happening in a developing country like Malaysia. This study used traffic data collected between Oct 2009 and Jan 2010 at a weigh station operated by the Malaysian Road Transport Department on Federal Route 54. Traffic data including the gross vehicle weight (GVW) were obtained. A series of summarized statistics, mainly focusing on 2-axle, 3-axle and 4-axle trucks, were presented in this paper.

This paper is included in the literature review of new material to illustrate the breadth of use of violations data in road safety.

## CHAPTER 3 – COMPARISON OF RESULTS BETWEEN 2014 CTSW STUDY AND PREVIOUSLY PUBLISHED TRUCK SIZE AND WEIGHT STUDIES

### 3.1 Purpose

The purpose of this report is to compare principal results of the Safety Comparative Analysis (Task V.A.) with other similar studies available in the literature. This involves two main objectives. First, those documents summarized in the revised desk scan that contain quantitative results pertaining directly to enforcement costs and effectiveness (*i.e.*, the main objectives of the current 2014 CTSW Study) are identified. Second, the results from each of the selected documents are reviewed and objectively compared with the results of the 2014 CTSW Study. Two types of comparisons are provided: (1) those pertaining to the scenario results; and (2) other CTSW Study results.

### 3.2 Comparison of Safety Study Findings

The Safety Comparative Analysis (Task V.A.) compares the results of the 2014 Comprehensive Truck Size and Weight Safety Study with estimates of the safety performance of several tractor - trailer combinations from the existing safety literature.

**Table 3-1** summarizes the findings of several key crash studies conducted over the last 20+ years. One can quickly see that there are no findings for LCVs, only for single and double combinations. This is because in all the studies there persisted this issue of a lack of sample size and data detail for LCV crashes. A few studies had results for triples or other double combinations, but review of the reports revealed that the sample size of annual crashes was 20 or less. The team also opted not to include the findings of the study by Dr. Sowers as Dr. Dan Blower profoundly critiqued this research.

A first comparison can be made of the internal consistency of the CTSW estimates for tractor semitrailers and double trailer combinations. While the rural and urban interstate rates vary from state to state, the rural interstate rates are around 0.5 or less for tractor semitrailers, close to the rate for double trailer combinations in Kansas. The 2014 study did not compute crash rates for double trailer combinations in Washington, Idaho and Michigan because it was not part of the scenario to do so. These results are similar to those of Abdel-Rahim using data from some of the same states, but in earlier years. The Western Uniformity Study has higher rates for both tractor semitrailers and double trailer combinations; it is difficult to say why, but that study drew crash data from many more states, so the many state-level differences (*e.g.*, reportability thresholds; data collection practices) may be at play. It is not possible to say much more.

It is more difficult to include the work by Campbell et al., in the comparison because the work involves fatal crashes only. The differences with respect to operating environment are generally the same with urban interstates have high rates then rural interstates. So, what can we conclude? We have some reasonably consistent crash rate estimates for double trailer combinations and single combinations, but there is virtually no information on LCVs. The table provides yet additional evidence of the need to enhance and fundamentally re-think how we address the safety implications of larger and heavier trucks. Previous studies did not conduct safety inspection and violations analyses as no studies of that type were found in the literature. As a consequence, a comparison could not be performed with regard to the current work.

**Table 3-1: Synthesis of Previous Studies**

| <b>Study</b>                 | <b>Crash Data Source</b>       | <b>Exposure Data Source</b>                                     | <b>Findings (Crashes per million vehicle miles)</b>                                      | <b>Comments</b>   |
|------------------------------|--------------------------------|---|--|---|
| Jovanis, et al., 1989        | Fleet records; all crashes     | Fleet dispatches for routes with both twins and 3-S2 operations | 3S2*: 3.83<br>Twin*: 3.52  | Data from one carrier; all crashes  |
| Campbell et al., 1988        | TIFA (1980-84)                 | NTTIS (1985)  | Single*: Rural 4.50<br>Urban 5.80<br>Double* Rural 4.06<br>Urban 4.30                    | From Western Uniformity Study Table VII – 7, Page VII – 17  |
| 2014 CTSW                    | Washington (2008-2011)         | WIM and FHWA VMT  | Single: Rural 0.27<br>Urban 0.35<br>Combined: 0.31                                       | Crash frequencies per year range from 85-100 in Idaho, to 270 in Michigan<br>Double trailer combinations sample sizes small in Washington, Idaho and Michigan |
|                              | Idaho (2008-2010)              | WIM and FHWA VMT  | Single: Rural 0.47<br>Urban 0.67<br>Combined: 0.51                                       |   |
|                              | Michigan (2008-2012)           | WIM and FHWA VMT  | Single: Rural 0.19<br>Urban 0.24<br>Combined 0.22  |   |
|                              | Kansas Turnpike (2008-2012)    | VMT (2008-2012)   | Single Rural 0.58<br>Urban 1.00<br>Double: Rural 0.46<br>Urban 0.53                      | Crash frequencies ranged from 50 to almost 80 per year  |
| Abdel-Rahim et al., 2013     | Utah (1999-2004)               | FHWA and WIM  | Tractor semitrailers: 0.48 to 0.81 per year<br>Twin: 0.48 to 1.06 per year               | Only computed crash rate per year all facilities; no route type breakdown   |
|                              | Idaho (2003-05)                |   | Single 0.78 to 0.92<br>Double 0.91 to 1.16   | Only computed crash rate per year all facilities; no route type breakdown   |
| Western Uniformity (1995-99) | Crash data from 13 WUSA States | VMT for study using FHWA VMT                                    | Rural Inter. – 1.50<br>single<br>1.83 multi<br>Urban Inter.<br>2.10 single<br>1.39 multi |   |

\* Include all crashes for firm, not just DOT reportable

\*\* These rates are fatal involvement rates per 100 million vehicle miles

\* Include all crashes for firm, not just DOT reportable

\*\* These rates are fatal involvement rates per 100 million vehicle miles

## CHAPTER 4 – TECHNICAL LINKAGE BETWEEN DESK SCAN AND PROJECT PLANS

### **4.1 Purpose**

The purpose of this report is to compare principal results of the Safety Comparative Analysis (Task V.A.) with other similar studies available in the literature. This involves two main objectives. First, those documents summarized in the revised desk scan that contain quantitative results pertaining directly to safety effectiveness (*i.e.*, the main objectives of the current 2014 CTSW Study) are identified. Second, the results from each of the selected documents are reviewed and objectively compared with the results of the 2014 CTSW Study. Two types of comparisons are provided: (1) those pertaining to the scenario results; and (2) other CTSW Study results.

### **4.2 Safety Analysis Linkages**

The safety team developed a unique approach to the safety assessment, especially in the critical crash analysis area. The team chose 3 alternative approaches to address the crash analysis and pursued them all. The state-level crash analysis is most similar to the Abdel-Rahim research. He developed his own algorithm for analysis of WIM data, while the safety team relied on the project lead on WIM analysis, Roger Mingo. The safety team used more current state crash data, but there was much similarity in the discussion of data difficulties. So, it seems clear that there is at least some connection between the analysis undertaken in the Abdel-Rahim study and the analyses completed in this 2014 CTSW study.

There was an added level of detail in the selection of states for participation in our efforts to adhere to scenarios guiding the analysis. Although there is a veneer of similarity in the two approaches, the effort we undertook was certainly guided by the need to estimate crash differences between the control and alternative vehicles in each scenario. As it turned out, we were only marginally successful in the state-level plan.

There were no references in the literature that were comparable to the route-level analysis or the proposed use of fleet data. The team understood the risks associated with both approaches but understood, from our knowledge of the literature, that some innovative ideas were needed. It was unfortunate that the WIM data were not more thorough across the network; that might have allowed us to develop a workable data set for the route analysis.

There were very strong connections between the desk scan material and the analysis of vehicle stability and control. The team was close to the 2000 CTSW Study efforts in this area and the methods were not dependent on data from the field. So, in the case of vehicle stability and control the linkage was very strong. Many of the same metrics were chosen, although the details of the simulation model likely changed substantially over the 15+ years that elapsed from the 2000 CTSW Study.

There was virtually no literature to guide the inspection and violation portion of the study. Again, we were guided by the scenario vehicles and most importantly, the congressional mandate to “. . . evaluate factors related to the accident risk of vehicles that operate with size and weight limits that are in excess of federal law and regulations in each State that allows vehicles

to operate with size and weight limits that are in excess of the Federal law and Regulations” . . . This led to the identification and comparison of vehicle that were operating legally but above 80,000 lb. We found no comparable research in the literature.

## CHAPTER 5 – REFERENCES

Aarts, L. and M. Honer (2010). Monitoring Traffic Safety Longer and Heavier Vehicles. The Netherlands, Directorate General for Public Works and Water Management.

AASHTO (2009). A Synthesis of Safety Implications of Oversize/Overweight Commercial Vehicles. Washington DC, American Association of State Highway and Transportation Officials.

Abdel-Rahim, A., S. G. Berrio-Gonzales, *et al.* (2006a). Classification of Longer Combination Vehicles Using Weigh-in-Motion Data. Final Report Part A. University of Idaho. National Institute for Advanced Transportation Technology.

Abdel-Rahim, A., S. G. Berrio-Gonzales, *et al.* (2006b). Longer Combinations Vehicles: A Comparative Crash Rate Analysis. Final Report Part B. University of Idaho. National Institute for Advanced Transportation Technology.

Alberta Transportation. Retrieved August 7, 2013, from <http://www.transportation.alberta.ca/Content/docType276/Production/lcv.pdf>.

Andersson, J. (2011). Trafi ksäkerhetspåverkan vid omkörning av 30-metersfordon, VTI, the Swedish National Road and Transport Research Institute.

Barton, R. and L.-P. Tardif (2003). Literature Review of the Safety of Long Combination Vehicles and their Operation in Canada: Final Report, Canada Safety Council.

Blower, D., K. L. Campbell, and P.E. Green (1993). “Accident Rates for Heavy Truck-Tractors in Michigan.” Accident Analysis and Prevention **25**(3): 307-321.

Blower, D. and L. C. Pettis (1988). National truck trip information survey (Version March 30, 1988). Ann Arbor, Mich., University of Michigan, Transportation Research Institute.

Braver, E. R., P. L. Zador, *et al.* (1997). “Tractor-trailer crashes in Indiana: A case-control study of the role of truck configuration.” Accident Analysis & Prevention **29**(1): 79-96.

Bureau of the Census. (2002). “Vehicle Inventory and Use Survey.” Retrieved August 7, 2013, from <http://www.census.gov/svsd/www/vius/2002.html>.

Cambridge Systematics, I. (2009). Wisconsin Truck Size and Weight Study. Madison, Wisconsin, Wisconsin Department of Transportation

Campbell, K. L.; Blower, D. F.; Gattis, R. G.; Wolfe, A. C. (1988). Analysis of accident rates of heavy-duty vehicles. Ann Arbor: University of Michigan Transportation Research Institute

Campbell, K. L., D. F. Blower, *et al.* (1996). Sources of exposure data for safety analysis. Ann Arbor, Mich., University of Michigan, Transportation Research Institute.

Carson, J. (2011). Directory of Significant Truck Size and Weight Research. Washington, DC.



Department of Transportation Idaho (2007). Three-year Report to the 59th Idaho Legislature on the 129,000 Pound Pilot Project, 2007 revised.

Department of Transportation Idaho (2013). 129,000 Pound Pilot Project, Report to the 62nd Idaho State Legislature.

Fancher, P. and K. Campbell (1995). Vehicle Characteristics Affecting Safety, Truck Size and Weight Study, Phase I: Working Papers 1 and 2 combined. Washington, DC. FHWA. Retrieved November 13, 2013 from <http://wwwcf.fhwa.dot.gov/reports/tswstudy/TSWwp1.pdf>

Fancher, P. S., D. F. Blower, *et al.* (1989). Turner truck handling and stability properties affecting safety. Volume I - technical report. Final report. Ann Arbor, Mich., University of Michigan, Transportation Research Institute.

FHWA (2000). Comprehensive Truck Size and Weight Study. Washington DC, US Department of Transportation.

FHWA (2012). Vermont Pilot Program Report. FHWA. Washington, DC. Retrieved November 13, 2013 from [http://www.ops.fhwa.dot.gov/freight/sw/reports/vt\\_pilot\\_2012/vt\\_pilot.pdf](http://www.ops.fhwa.dot.gov/freight/sw/reports/vt_pilot_2012/vt_pilot.pdf)

FHWA. (2013). "Highway Statistics." Retrieved July 20, 2013, from <http://www.fhwa.dot.gov/policyinformation/statistics.cfm>.

Forkenbrock, D. J. and P. F. Hanley (2003). "Fatal Crash Involvement by Multiple-Trailer Trucks." Transportation Research Part A **37**: 14.

Gross, Frank, Paul P. Jovanis, and Kimberly Eccles. "Safety effectiveness of lane and shoulder width combinations on rural, two-lane, undivided roads." *Transportation Research Record: Journal of the Transportation Research Board* **2103**.1 (2009): 42-49.

Hanley, P. F. and D. J. Forkenbrock (2005). "Safety of passing longer combination vehicles on two-lane highways." Transportation research. Part A, Policy and practice. **39A**(1): 15.

Harkey, D. L., F. M. Council, *et al.* (1996). "Operational Characteristics of Longer Combination Vehicles and Related Geometric Design Issues." Transportation Research Record **1523**: 22-28.

Hjort, M. and J. Sandin (2012). Trafiksäkerhetseffekter vid införande av längre och tyngre fordon, VTI, the Swedish National Road and Transport Research Institute.

Gabauer, D. J., (2012), Real-World Barrier Performance of Longitudinal Barriers Struck by Large Trucks, TRR 2309, Transportation Research Board, Washington D.C., p127-134.

Jarossi, L., D. Hershberger, *et al.* (2012). Trucks Involved in Fatal Accidents Codebook 2010. Ann Arbor, MI, UMTRI.

Jones, Ian S., and Howard S. Stein. "Defective equipment and tractor-trailer crash involvement." *Accident Analysis & Prevention* **21.5** (1989): 469-481.

- Jovanis, P., H.-L. Chang, *et al.* (1989). “Comparison of Accident Rates for Two Truck Configurations.” Transportation Research Record **1249**.
- Jovanis, Paul P., and Francis Gross. “Estimation of safety effectiveness of changes in shoulder width with case control and cohort methods.” *Transportation Research Record: Journal of the Transportation Research Board* 2019.1 (2007): 237-245.
- Knipling, RR, P Waller, RC Peck, R Pfefer, TR Neuman, KL Slack, and KK Hardy, (2004), NCHRP 500, volume 13, A Guide for Reducing Collisions Involving Heavy Trucks, Transportation research Board, Washington, D.C.,
- Knight, I., W. Newton, *et al.* (2008). Longer and/or Longer and Heavier Goods Vehicles (LHVs) – a Study of the Likely Effects if Permitted in the UK. Published Project Report PPR285, TRL.
- Lemp, J. D., K. M. Kockelman, *et al.* (2011). “Analysis of Large Truck Crash Severity Using Heteroskedastic Ordered Probit Models.” Accident Analysis and Prevention **43**(1): 11.
- Matteson, A., L. Pettis, *et al.* (2007). Trucks Involved in Fatal Accidents Codebook 2004. Ann Arbor, MI, UMTRI.
- Montufar, J., J. D. Regehr, *et al.* (2007). Long Combination Vehicle (LCV) Safety Performance in Alberta: 1999-2005. Alberta, CA, Alberta infrastructure and Transportation Policy and Corporate Services Division.
- NCSA (2011). Fatality Analysis Reporting System (FARS) Analytical Users Manual, 19752010. Washington, DC, USDOT NHTSA.
- NHTSA (2011). National Automotive Sampling System (NASS) General Estimates System (GES) 2010 Coding and Editing Manual. Washington, DC.
- NTC (2008). Performance Based Standards Scheme - The Standards and Vehicle Assessment Rules, National Road Transport Commission, Australia.
- Ontario Ministry of Transportation (2011). Long Combination Vehicle Program Review. Toronto, CA, Ontario Ministry of Transportation, Transportation Policy Branch.
- Organisation for Economic Co-operation and Development (2011). Moving Freight with Better Trucks: Improving Safety, Productivity and Sustainability, OECD Publishing.
- Prem, H., E. Ramsay, *et al.* (2001). Definition of Potential Performance Measures and Initial Standards, National Road Transport Commission, Australia.
- Regehr, J. D., J. Montufar, *et al.* (2009). “Safety performance of longer combination vehicles relative to other articulated trucks.” Canadian Journal of Civil Engineering **36**(1): 10.
- Rossetti, M and M. Johnsen, (2011). Weather and Climate Impacts on Commercial Motor Vehicle Safety, USDOT, RITA, FMCSA-RRA-11-013. 86p.

Scopatz, R. A. (2001). "Crashes Involving Long Combination Vehicles: Data Quality Problems and Recommendations for Improvement." Transportation Research Record **1779**.

*Sowards, K., E. Eastman, J. Matthews and E. Pennington, (2013), "An Analysis of Truck Size and Weight: Phase I – Safety," Multimodal Transportation & Infrastructure Consortium, Marshall University*

Stein, Howard S., and Ian Shore Jones. "Crash involvement of large trucks by configuration: a case-control study." *American Journal of Public Health* 78.5 (1988): 491-498.

TRB (1990a). Special Report 225: Truck Weight Limits, Issues and Options. Washington, DC, Transportation Research Board.

TRB (1990b). Special Report 227: New Trucks for Greater Productivity and Less Road Wear: An Evaluation of the Turner Proposal. Washington, DC, Transportation Research Board, National Research Council.

USDOT (2004). Western Uniformity Scenario Analysis, Washington, DC, US Department of Transportation.

Wilbur Smith Associates, Woodrooffe and Associates, *et al.* (2004). Study of Impacts Caused by Exempting the Maine Turnpike and the New Hampshire Turnpike From Federal Truck Weight Limits.

Woodrooffe, J. (2001). Long Combination Vehicle Safety Performance in Alberta 1995 to 1998, Woodrooffe & Associates.

Woodrooffe, J. (2013). Performance Based Standards and Indicators for Sustainable Commercial Vehicle Transport.

Woodrooffe, J., D. Anderson, *et al.* (2004). The Influence of Policy on Crash Rates of Long Combination Vehicles. 8th International Symposium on Heavy Vehicle Weights & Dimensions, Johannesburg, South Africa.

Woodrooffe, J., R. J. Billing, *et al.* (2010). Review of Canadian Experience with Regulation of Large Commercial Motor Vehicles. Washington, DC, TRB.

Woodrooffe, J., K. P. Glaeser, *et al.* (2010). Safety, Productivity, Infrastructure Wear, Fuel Use and Emissions Assessment of the International Truck Fleet-A Comparative Analysis. OECD International Transport Forum, Paris, France.

**APPENDIX A – SUMMARY OF ADDITIONAL RESPONSES TO  
NAS PEER REVIEW PANEL ISSUES**

This section summarizes our response to detailed comments concerning the safety desk scan that were contained on Pages 32-38 of the NAS Peer Review Panel Letter report. Our intention is to demonstrate that we carefully reviewed the panel suggestions, even though we were unable to expansively address all of them.

There were several comments in support of the route-based analysis described in the project plan. Unfortunately the WIM data would not support such an analysis, which was a broadly conceptual idea. The safety team knows of no studies that have conducted using such an analysis. This topic is mentioned in the discussion of future research methods in response to Task 2.1 c of the revised desk scan.

The NAS Peer Review Panel inquired about practice of coupling liberalization of limits with special mitigation requirements is common in the United States and other countries. Responding to this request would have required extensive review of additional material to make this connection. While an excellent idea, it was beyond the scope of conduct for new research. The safety team has retained the existing discussion concerning much of the non-U.S. experience with regulatory change and placed it in Appendix B.

An additional comment focused on the advantages of including driver attributes as part of the CTSW in the future. The team has included a discussion of the UMTRI TIFA/NTTIS approach that can include driver attributes. The panel letter mentions fleet data as a method to obtain driver attributes; our experience with fleets is that this will take substantial effort and is best implemented as part of a long-term data collection strategy such as is discussed in Task 2.3. Among the many challenges will be a need to obtain comparable driver detail for non-crash-involved drivers as a means of exposure. This would be difficult unless some type of case-control formulation is used.

It is recognized that there is a gap in the desk scans concerning studies of the safety and environmental costs of increasing the extent or duration of work zones. We have included a discussion of how the safety implications of work zones might be included in future CTSW studies. This would be a particularly challenging undertaking as most work zone safety literature involves trials of a particular device within or before a work zone.

## APPENDIX B – OBSERVATIONAL AND PILOT STUDIES OF LONGER/HEAVIER TRUCKS

Woodrooffe reviewed the safety performance of LCVs in Alberta, Canada between 1995 and 1998 (Woodrooffe, 2001). LCVs include double trailer combinations and triples longer than 25 m, including Rocky Mountain double trailer combinations, turnpike double trailer combinations, and triples. LCVs are restricted to certain routes (highway types), certain times of day in holiday periods (when there might be more congestion from holiday travelers), specific driver training and experience requirements, minimum required power-to-weight ratios, and the use of certain hitch types. In addition, LCVs are restricted from operating in adverse weather conditions, and at certain times of day in and around specified cities. Finally, there were time-of-day restrictions on two-lane highways. While the study found that LCV had generally lower crash rates than other configurations, the conditions in Canada are sufficiently different than in the U.S. to preclude any more detailed comparison.

Montufar *et al.* (2007) extended and expanded the Woodrooffe work in Alberta in 2007. The study developed exposure measures using vehicle count data on roadway segments, distributions of gross weight from WIM stations, a survey of vehicle length on one stretch of highway for one year, vehicle classification counts at selected stations, and a roadside survey of fleet mix data. These data were used to develop estimates of VKT (vehicle kilometers of travel) for routes on which LCVs were permitted to operate. Configurations considered in the analysis include straight trucks, tractor-semitrailers, “legal-length” double trailer combinations (STAA double trailer combinations), Rocky Mountain double trailer combinations, turnpike double trailer combinations, and triples. Alberta has among the most stringent driver, carrier, and vehicle regulations on LCVs in the CANAMEX corridor (Canada, US and Mexico). Once again, LCVs had lower crash rates than other trucks, but this finding cannot be extrapolated to U.S. conditions.

This work was also summarized in Regehr *et al.*, which concluded, “The relatively superior safety performance of LCVs in Alberta may result in part from the stringent conditions placed on their operations through the design and enforcement of special permits. Principal along these is the requirement for experienced, specially-qualified driver for LCV movements” (Regehr, Montufar *et al.* 2009).

Abdel-Rahim *et al.* performed a similar study of LCVs in several western states, which includes some of the states on the CANAMEX corridor referred to above. A goal of the study is to calculate crash rates for the different LCV configurations. A survey of existing crash and VMT data showed that despite the fact that different types of LCVs are allowed to operate on the highways in several Western states, only Utah can identify in its crash data standard double trailer combinations as well as RMD, TPD and triples. The authors developed a method to estimate LCV travel using WIM-station data and vehicle classification counts. (The method is documented in a companion report (Abdel-Rahim, Berrio-Gonzales *et al.* 2006a).) Crash rates were calculated for Utah and Idaho. Because of limitations in the Idaho crash data, crash rates could only be calculated by truck configuration, distinguishing tractor semitrailers, double trailer combinations and triples. Specific LCV types such as turnpike double trailer combinations and Rocky Mountain double trailer combinations cannot be identified in the crash data.

In terms of severity, tractor semitrailers and double trailer combinations had similar distributions of crash severity in the states examined. For example, in Idaho, about 3% of crash involvements for each involved a fatality, about 30-33% included an injury, and the remainder involved only property damage (PDO). Among crashes involving triples, only about 2% were fatal crashes and only 13% involved an injury. However, there were only 14 triples crashes over the entire period covered by the data (1999-2005), limiting the usefulness of this finding. Utah crash data can identify RMD, TPD and triples, as well as tractor semitrailers and standard double trailer combinations. In the Utah crash data, the proportion of fatal crashes was about the same for each of these truck types.

In Idaho, crash rates were calculated by year for tractor semitrailers, double trailer combinations, and triples, on state roads and on interstate highways. On state roads, double trailer combinations and triples consistently had higher crash rates than tractor semitrailers, ranging from about 25% to about 50% higher. Triples had somewhat lower crash rates than double trailer combinations on state roads, though it should be noted that there were only six crashes involving triples combinations in three years on Idaho state highways. There were 469 tractor semitrailers and 85 double trailer combinations crashes. On Interstate highways, triples had lower crash rates than either tractor semitrailers or double trailer combinations – about 15% lower than tractor semitrailers and about 30% lower than double trailer combinations. There were 887 tractor semitrailers crashes, 109 double trailer combinations and 36 triples. Tests indicated that the differences between tractor semitrailers and double trailer combinations and between tractor semitrailers and triples were statistically significant.

For Utah, crash rates could be calculated for tractor semitrailers, standard double trailer combinations, RMD, TPD, and triples. The results showed tractor-semitrailers with the lowest overall crash rates, compared with standard double trailer combinations and each of the LCV types. On average, crash rates for RMD were about 60% higher, rates for TPD were over twice as high, and triples' crash rates were 38% higher. Statistical tests showed that each of the differences was statistically significant (Abdel-Rahim, Berrio-Gonzales *et al.* 2006b).

There has been a series of recent pilot studies within states or groups of states to test the effect of temporarily increasing weight limits on selected roads. In 2013, the State of Idaho issued a final report on the ten-year project to determine the effect of increasing weight limits on state highways (Department of Transportation Idaho, 2013). Despite this extensive effort, most carriers were not willing or able to change equipment or operations to take advantage of the higher permitted weights. No statistically significant effect was observed. There was a 4.1% increase in truck crash rates on pilot routes in comparison with non-pilot routes. Pilot routes with the greatest utilization by the 129,000 lb. trucks also experienced a slight increase, but again, it was not statistically significant. The study was unable to control for any potentially confounding factors, such as changes in the operating environment.

Vermont also implemented a pilot project to assess the effect of increasing weight limits on interstate highways. The pilot allowed 6-axle, 99,000 lb. GVW tractor-semitrailers on interstate highways. In addition, restrictions were dropped on several other configurations that had been allowed on state roads, but would be allowed on Interstates under the pilot. These trucks include 3-axle 55,000 lb. GVW, 4-axle 69,000 lb. GVW, 5-axle 90,000 lb. GVW, and 6-axle 99,000 lb. GVW. The project was a one-year study that assessed effects on truck volumes, the vehicle fleet,

damage to pavement and bridges, and fuel consumption, in addition to safety. Highway safety was measured in terms of the number of truck crashes on the interstate and state highways, and the number of fatal truck crashes (FHWA, 2012).

The results with respect to safety were inconclusive. The study reported that no changes in crash rates were statistically significant.

The State of Wisconsin commissioned a study to evaluate the consequences of increasing weight limits on Wisconsin roads (Cambridge Systematics, 2009). The study evaluated several specific configurations, which were not currently in use on any roads in the state, but which might be permitted in the future using assumptions from previous studies rather than crash data *per se*.

The subject of a Maine/New Hampshire study was the obverse of the other recent states studies: Instead of the consequences of raising allowable weights on interstate roads, the study addressed the consequences of reversing an exemption that allowed trucks over 80,000 lbs. on the Maine Turnpike. The basic study approach is to compare the safety of the exempt trucks on the Maine turnpike with their crash experience on the roads to which they would be diverted. Estimates of VMT were developed from commodity flow data and models, along with vehicle classification counts and weigh-in-motion data from roadway segments. Using this information, VMT was estimated for different truck types and routes, along with estimated changes to VMT if the exemption was removed. The study assumed that drivers would choose the most time-efficient route between origin and destination.

The results show that crash rates for 5- and 6-axle tractor semitrailers on the Maine Turnpike are 1/4th the rates on the diversion routes. Three years of crash data (2000-2002) were used in the calculation, amounting to a reported 1,000 crashes, so the result should be statistically robust, even though confidence intervals were not determined. The difference was consistent with the common finding that crash rates are lower on higher quality roads.

The study also considered the effect on crash severity. Off the Turnpike, crashes on the diversion routes include more intersection, head-on, opposite direction sideswipe, and rear-end/sideswipe (likely same-direction sideswipes). Most of the roads the exempt trucks would be diverted to are two-lane -way roads. Crash rates by severity are all higher on the lower-quality roads. Overall, the analysis found that removing the exemption from Federal weight limits would result in an increase of 1.2 crashes per year and increased crash costs (Wilbur Smith Associates, Woodrooffe and Associates *et al.* 2004).

## APPENDIX C – INTERNATIONAL EXPERIENCE

### **C.1 Alberta LCV**

Details on the Alberta LCV program were found on the Provincial website (Alberta Transportation). Long Combination Vehicles (LCVs)<sup>7</sup> are truck and trailer combinations, consisting of a tractor with two or three trailers or semitrailers, in which the number of trailers and/or the combined length of the combination exceed the regular limits of 25 meters (82 feet). These vehicles have been operating on Alberta highways since 1969, when triple trailer combinations were introduced. Currently in Alberta, the maximum gross vehicle weight applicable to LCVs is 62,500 kilograms while the maximum configuration length is 37 meters (121.4 feet). A description of the Alberta LCV configurations follows:

- **Rocky Mountain Double** – A combination vehicle consisting of a tractor, a 12.2 m (40 feet) to 15.2 m (53 feet) semitrailer, and a shorter 7.3 m (24 feet) to 5.5 m (28 feet) semitrailer. The total length does not exceed 31 m (102 feet). These vehicles are typically used when cargo considerations are governed by weight rather than the cubic capacity of the trailer.
- **Turnpike Double** – A tractor plus double trailers. Each trailer is between 12.2 m (40 feet) and 16.2 m (53 feet) long. The Turnpike Double is typically used for carrying cargo that benefits from the additional cubic capacity of the trailer arrangement.
- **Triple Trailer** – This combination consists of a tractor with three trailers of approximately the same length. The typical trailer length is approximately 7.3 m and 8.5 m (24 to 28 feet). The Triple Trailer is used for carrying cargo that benefits from the additional cubic capacity of the trailer arrangement or from the operational flexibility of having three smaller trailers that can be easily redistributed as separate vehicle units at the point of origin and destination.

The province of Alberta has had long standing policy governing LCV operations under a special permit system. The policy is structured to maximize safety by placing controls on the operation and driver qualifications. The policy can be found on the province of Alberta's website (<http://www.transportation.alberta.ca/Content/docType276/Production/lcv.pdf>).

#### ***C.1.1 General Provisions***

The following is an edited summary of the provisions that apply to the permit holders.

- The permit holder must formally agree to abide by the routes, vehicle dimensions, equipment and conditions specified and carry a copy of the appropriate permit in each power unit.
- The permit holder must provide any reasonable statistics related to LCV operations to the province.

---

<sup>7</sup> Also known as Energy Efficient Motor Vehicles (EEMVs).



- The permit holder must investigate and document the findings of every traffic accident involving a vehicle registered to the permit holder for more than 4,500 kilograms or a passenger vehicle originally designed to transport 11 or more persons, including the driver, that resulted in:
  - The death of a person;
  - An injury requiring treatment by a medical doctor;
  - A condition that causes an employee to lose consciousness; or
  - Damage to all property, including cargo, totaling \$2,000 or more.
- Collisions found to have occurred while operating under permit must be evaluated to determine if the collision was preventable on the part of the permit holder and/or their driver(s). Each evaluation must use the criteria established by the National Safety Council ([www.nsc.org](http://www.nsc.org)). Verified non-preventable collisions are not used when evaluating the carrier's risk associated with operation under the permit.
- The permit holder must ensure, and be able to provide proof, that their drivers and driver trainers meet and maintain the requirements specified by the program.
- Prior to issuing an LCV Driver's Certificate, the carrier must ensure the driver meets the following qualifications:
  - Holds a valid Class 1 driver's license or equivalent;
  - Has a minimum of 24 months or 150,000 km of driving experience with articulated vehicles;
  - Has passed a Professional Driver Improvement Course within the past 48 months;
  - Has passed the Alberta Motor Transport Association's "Longer Combination Vehicles Driver Training Course";
  - The driver's abstract, dated not more than one month prior to the issue date of the Drivers Certificate, must show no driving-related criminal code convictions in the prior 36 months; no more than 2 moving violations in the prior 12 months; and no more than 3 moving violations in the prior 36 months; and
  - In the past 12 months the driver has reviewed all current regulations, permit conditions and issues covering the operation of LCV's.
- A driver-in-training may operate a long combination vehicle, while accompanied by a driver who holds a valid LCV Driver's Certificate

### ***C.1.2 Equipment Requirements***

- All tractors must feature a maximum gross weight to power ratio of no more than 160 kg per horsepower (120 kg/kW).
- Tractor air supply – compressors must be capable of raising the air pressure from 50 PSI to 90 PSI with the engine idling at 1,250 RPM in two minutes or less with the tractor alone and four minutes or less with the trailers hooked up and the complete air system energized.

- Air reservoirs – tractors must be equipped with at least two air reservoirs. Each reservoir must have at least 41,000 cm<sup>3</sup> (2,500 in<sup>3</sup>) of capacity. The two tanks must have a combined capacity of 82,000 cm<sup>3</sup> (5,000 in<sup>3</sup>).
- Brake relay valves – compatible relay valves are required to reduce the time lapse between treadle application and brake application at the rear most trailer.
- The rear axle group of the power unit and all axle groups of the trailers and converters must be equipped with mud flaps or splash guards that are constructed to ensure that they remain in a rigid downward position at all times. All mud flaps or splash guards shall be mounted behind the wheels at a distance not exceeding 25.0 cm (10 inches) to the rear of the wheels.
- The trailers of the combination shall be joined together by means of no-slack pintle hook(s), equipped with an air or hydraulic ram. The no-slack ram is to be incorporated in either the pintle hook or the pintle hook eye of the coupling apparatus.
- The allowable tire and axle weight limits are specified by the special permit program

### ***C.1.3 Operational Requirements***

- Any breakup or makeup of an LCV must be done off public roadways on private property or as directed by an authorized Alberta Transportation staff member or peace officer.
- The vehicles in a combination shall be so loaded and coupled together so as to ensure that any such combination travelling on a level, smooth, paved surface will follow in the path of the towing vehicle without shifting, swerving, or swaying from side to side over 10 cm to each side of the path of the towing vehicle when it is moving in a straight line.
- Drivers shall avoid crossing opposing lanes of traffic unless absolutely necessary.
- Maximum speed shall be the lesser of 100 km/h (62 mph) or the posted speed limit.
- The permit cannot be combined with any other permit for overwidth, overheight, overhang, or overweight.
- All provincial and municipal road bans shall be observed unless specified otherwise.

### ***C.1.4 Adverse Weather***

*For multi-lane highways:*

- LCV's shall not cross oncoming lanes where visibility does not allow it to be done safely.
- Where there is accumulated snow on the highway or when the highway is icy, LCV's shall not pass any other vehicle unless that vehicle is traveling at a speed of less than 70 km/hr. (45 mph).

- Where a highway becomes impassible due to icy or slippery conditions, LCV's will obey all advisories posted by the authority of Alberta Transportation.

*For two-lane highways:*

LCV's shall not operate during adverse weather or driving conditions (including but not limited to rain, snow, sleet, ice, smoke, fog or other conditions) which:

- Obscure or impede the driver's ability to drive in a safe manner; and
- Prevent the driver from driving with reasonable consideration for the safety of persons using the highway.
- The permit holder is required to make a reasonable effort to determine the driving conditions on the route. Vehicles must not be dispatched when adverse conditions are known to be present on the route. Drivers encountering unexpected adverse conditions must stop at the next safe location (or as directed by an authorized Alberta Transportation staff member or a peace officer) and wait for the adverse conditions to abate.

### ***C.1.5 Hours of Operation***

Operation will be allowed 24 hours per day except in the following cases:

On all Highways, movement will not be allowed after 4:00 pm on December 24 and December 31. On Two-lane Highways for weekends with no special holiday on the Friday or the Monday, movement will not be allowed from 4:00 pm to 8:00 pm on Friday and from 4:00 pm to 8:00 pm on Sunday. For a long weekend when a special holiday falls on a Friday, movement will not be allowed from 4:00 pm to 8:00 pm on the preceding Thursday and from 4:00 pm to 8:00 pm on Sunday. For a long weekend when a special holiday falls on a Monday, movement will not be allowed from 4:00 pm to 8:00 pm Friday and from 4:00 pm to 8:00 pm on the Monday.

In addition to the general hours of operation restrictions, there are workday and weekend time of day restrictions tied to specific road sections where congestion is problematic.

### ***C.1.6 Exemptions for Vehicle Length***

Aerodynamic devices are excluded from the measurement of overall length, provided that:

- Any portion of the device more than 1.9 meters (6 feet) above the ground does not protrude more than 0.61 meters (2 feet) beyond the rear of the vehicle; and
- Any portion of the device within 1.9 meters (6 feet) of the ground does not protrude more than 0.30 meters (1 foot) beyond the rear of the vehicle.

Heavy duty bumpers and devices designed to reduce the impacts of wildlife collisions are excluded from the measurement of overall length, provided that:

- Bumpers and devices do not extend more than 0.30 meters (1 foot) beyond the front of a truck tractor.

In addition to the requirements listed above, there are configuration specific requirements with respect to vehicle weight that are specified in the policy document for safety reasons.

For the Rocky Mountain Double configuration (see **Figure C-1**):

**Figure C-1: Rocky Mountain Double configuration**



- In all cases, the lead semitrailer of the configuration must be heavier than the second trailer or semitrailer; and
- An empty converter dolly may be towed behind the combination so long as the overall length does not exceed the limits stated on this page, and the dolly is equipped with all legally required lights and equipment.

For the Turnpike Double configuration (see **Figure C-2**):

**Figure C-2: Turnpike Double configuration**



- In all cases, the lead semitrailer of the configuration must be heavier than the second trailer or semitrailer;
- Turnpike double trailer combinations may include a tridem axle group on the second trailer; and
- An empty converter dolly may be towed behind the combination so long as the overall length does not exceed 41 meters (135 feet) and the dolly is equipped with all legally required lights and equipment.

For the Triple Trailer configuration (see **Figure C-3**):

**Figure C-3: Triple Trailer configuration**



- In all cases, the lead semitrailer of the configuration must be heavier than the second trailer or semitrailer and the third trailer or semitrailer is the lightest;
- An empty converter dolly may not be towed behind a triple trailer combination; and
- In order to qualify for the 38 m length (125 feet), both trailers two and three must be coupled by a B converter.

## **C.2 Ontario LCV Program**

Long Combination Vehicles began operating in Ontario in August 2009 under a program similar to the Alberta LCV program. However unlike Alberta, the Ontario program is seasonal in that LCVs are not permitted to operate during the winter months of December, January and February. The program is tightly focused on safety and has the following objectives taken from a program review published by Ontario Ministry of Transportation, Transportation Policy Branch (MTO) (Ontario Ministry of Transportation 2011):

1. Safety – Ontario’s top priority is to make Ontario’s roads the safest in North America.
2. Through strong program conditions, Ontario ensures LCV operations are safe.
3. Economy – LCVs have economic benefits for shippers and carriers with consolidated loads using fewer resources. LCV program is part of the harmonization efforts with Quebec to make it easier for shippers to move goods across provincial boundaries.
4. Environment – Greenhouse gas emissions are directly linked to the amount of fuel consumed.
5. LCVs use approximately 1/3 less fuel than two tractor-trailers.
6. Infrastructure Protection – LCV vehicle weights and dimensions standards minimize damage to roads and bridges.
7. Congestion Reduction – LCVs operate outside of rush hour periods in the Greater Toronto Area (GTA).

Limited capacity at rest stops for carriers to use in emergencies has been identified as a potential challenge with expanded LCV operations. Carriers are confident that their dispatching procedures will allow them to work their way through bad weather or traffic issues. MTO

continues to work with the industry to address the need for additional rest/emergency stops in key parts of the LCV network.

MTO maintains a careful approach to LCV program management and monitoring to ensure safe and efficient operations. Regular program management tasks include monitoring monthly carrier trip records, and continued random checks of specific trip details to ensure compliance with program conditions. With respect to broader aspects of the program, MTO continues to work with Ontario Trucking Association (OTA) to develop an improved Rest/Emergency Stop Network, as well as work with Quebec and other provinces to better harmonize LCV program conditions.

Several sources of data and information are used to monitor ongoing performance of LCVs, including information obtained from program participants.

1. All carriers participating in the program are required to maintain a record of each LCV trip. The recorded trip information includes the driver's name, the trip origin and destination, commodities carried and the trip distance. For each trip, carriers must also indicate the probable alternative mode of transport (truck, rail, other) had LCVs not been available. This information is submitted to MTO on a monthly basis and provides a basis for certain components of this review.
2. MTO also requests additional data related to driver qualifications, vehicle standards and speed recordings for selected trips from a random sampling of carriers on a regular basis. This is one of the methods used to verify compliance with program requirements.
3. Ontario LCVs are made up of a tractor pulling two full-length semitrailers up to 40 meters (131 feet) in overall length.
4. Participating carriers are responsible for verifying that drivers and instructors meet the specified qualifications, training and experience, and have obtained an OTA-issued certificate. This includes ensuring that:
  - LCV drivers are proven safe and reliable tractor-trailer operators with a minimum of 5 years of experience;
  - All LCV drivers successfully complete specified LCV driver training that includes classroom, yard and on-road training and evaluation, including at least 1,000 km of practical LCV experience;
  - LCV instructors have at least 10,000 km of LCV experience; and
  - Carriers are required to enter into a Memorandum of Understanding (MoU) with MTO signifying that the carrier accepts responsibilities as outlined in the program conditions. All approved carriers must maintain a satisfactory Carrier Safety Rating, not just in their LCV operations but in all their operations.

Strict guidelines detailing the vehicle configuration, dimensions and weight allowances are specified in the permit conditions. LCVs cannot be heavier than single tractor-trailers (i.e., 63,500 kg = 140K lb.). LCVs are required to have special equipment including horsepower

minimums, on-board speed recording devices, anti-lock braking systems (ABS), additional lighting, rear signage and electronic stability control (ESC).

LCV permits have specific and detailed operating restrictions that outline where and when participants may operate these vehicles. Permit conditions outline that LCVs may only operate on approved routes, must not detour off approved routes for any reason, including for road closures, and must not operate on any routes on the evening preceding and the last evening of long weekends.

LCVs must not exceed a speed of 90 km/h, and must not travel in the Greater Toronto Area during morning and afternoon rush hours. They are not permitted to carry livestock or dangerous goods requiring a placard. LCVs must not operate during the winter months of December, January and February and must not operate during inclement weather, poor visibility or poor road conditions.

### ***C.2.1 Carrier Qualifications***

In Ontario, carriers must have at least five years trucking experience, maintain a ‘satisfactory’ Carrier Safety Rating and have at least \$5 million liability insurance. Participating carriers are expected to enter into a Memorandum of Understanding (MOU) with MTO signifying that the carrier accepts all responsibilities as outlined in the program conditions document. As well, the carrier must have resources to acquire specialized equipment, train instructors and drivers and engage engineering consultants to assess proposed routes.

If the carrier fails to meet or maintain the high standards set out in the program conditions, they are denied entry into the program or, if they have already been issued permits, those permits are automatically revoked. The potential loss of LCV permits provides a significant incentive for these carriers to ensure all of their operations meet high safety standards.

### ***C.2.2 Driver Qualifications***

Drivers must have an OTA-issued LCV Driver Certificate based on a valid Class A driver’s license with Z (air brake) endorsement, or equivalent from another jurisdiction, and a minimum of five years provable tractor-trailer driving experience. Drivers must not have had more than two moving violations within the past year, or more than three moving violations in the past two years, and no driving-related criminal code convictions within the past three years.

Each driver must successfully complete the OTA LCV Driver Training Program. This program includes classroom, yard and on-road training and evaluation, including at least 1,000 km of practical LCV experience with a trainer. Alternatively, the driver may have successfully completed an approved Canadian Trucking Alliance (CTA) LCV driver training program in another province or have a Quebec “T” license endorsement issued prior to June 1, 2009, including at least 1,000 km of LCV experience.

LCV instructors may be employed by carriers as ‘in-house’ driver-trainers or may be attached to an appropriate training organization. The instructors must be qualified LCV drivers themselves and possess an up-to-date OTA-issued LCV Instructor Certificate, which allows them to train Ontario LCV drivers. In addition, LCV instructors must have at least 10,000 kilometers of LCV

driving experience. Instruction may only be given to drivers of carriers possessing valid LCV operating permits on approved routes and equipment.

### ***C.2.3 Route Conditions***

LCVs are only allowed to operate on designated, approved routes in Ontario. This consists of the primary highway network, rest/emergency stops and origin/destination locations.

The primary LCV highway network consists of 400-series (and similar) highways individually authorized for general LCV travel. Highways must be multilane with controlled access. MTO required the OTA to undertake a full assessment of the highway network to ensure the highways could accommodate LCVs. This included engineering assessments for all the highway-to-highway ramps to identify those ramps that could accommodate LCVs. Some ramps were found to be unacceptable for LCV operations. These are excluded from the primary LCV highway network.

Origin/Destination locations must generally be within km of a primary highway. All off-highway travel to or from any LCV origin or destination location requires a full engineering assessment of the route prior to approval. Carriers are responsible for conducting an engineering assessment of the access route and obtaining any municipal approvals for travel on municipal roads.

## **C.3 OECD Moving Freight in Better Trucks**

The International Transport Forum at the OECD produced two reports (Woodrooffe, Glaeser *et al.* 2010; Organisation for Economic Co-operation and Development 2011) dealing with the analysis of more productive vehicles. The purpose of the reports was to “identify potential improvements in terms of more effective safety and environmental regulation for trucks, backed by better systems of enforcement, and to identify opportunities for greater efficiency and higher productivity.” The two topic areas most relevant to this desk scan are heavy truck safety and the evaluation of truck performance.

First, the studies noted that there was a need for additional research in several safety areas. These areas include the potential aggravation of the consequences of accidents when higher capacity vehicles are involved and possible countermeasures to mitigate these consequences, and the effect of vehicle length on the risk of overtaking and on visibility reduction for other road users.

The studies also commented that government intervention in trucking and associated activities is extensive. It includes regulation of vehicle weights and dimensions, technical characteristics of vehicles, vehicle access to the road network, driver licensing and behavior and the practices of transport operators. In some instances, trucking regulation is fragmented (between jurisdictions), prescriptive, and possibly slow to respond to changing technology, industry needs and community expectations. The study concludes that these issues undermine regulatory effectiveness.

The studies found that in Canada and Australia in particular, the current trends in trucking enforcement include:

- Electronic detection of non-compliance;



- Use of information technology to gather and apply information on patterns of behavior, to enable the focusing of enforcement resources on high-risk drivers and operators;
- Use of accreditation and safety ratings schemes to encourage the application of safety
- Management systems; and
- Imposition of legal requirements on off-road parties with control over truck operations.

It was concluded that, in general, regulatory enforcement can benefit from the same advances in technology and management as general transport operations, using vehicle positioning systems, weigh-in-motion systems, on-board monitoring systems and detection and measurement equipment at the roadside and embedded in the roadway, *e.g.*, advanced weigh-in-motion systems. The safety benefits of many of these regulatory approaches have yet to be quantified.

Most requirements relating to vehicle weights and dimensions are prescriptive. They have evolved over a long period and with significant regional differences, including within federal jurisdictions. Canada pioneered the use of performance standards for trucks in the 1980s. The current CTSW Study safety team believes that there is some evidence that this approach has benefitted Canada, but it yet to be proven that a similar approach would be workable in the U.S.

The study notes that lack of detailed data makes it difficult to assess crash risk on an individual truck basis. A study by TRL in the U.K. (Knight, Newton *et al.* 2008) assessed the various consequences of allowing different types of larger trucks than the current limits; the authors found likely increases in crash risks per vehicle km, but decreased crash risks per unit of goods moved.

Studies of experiences in Canada (Barton and Tardif 2003; Woodrooffe, Anderson *et al.* 2004; Montufar, Regehr *et al.* 2007; Regehr, Montufar *et al.* 2009) found that accident involvement of higher productivity vehicles per kilometer are significantly less than those of single trailer trucks in general operations. The 2009 study found, however, that the relatively superior safety performance of LCVs in Alberta might result in part from the stringent conditions placed on LCV operation through the design and enforcement of special permits. Principal among these is the requirement for experienced, specially qualified drivers for LCV movements. The CTSW Study safety team believes that these studies support the *potential* for LCVs to be able to retain or enhance safety, but more definitive experience and analysis is needed.

The OECD study further concludes that computer simulations show major variations in truck performance, with some Higher Capacity Vehicles (HCVs) performing better than today's workhorse trucks. A comparative analysis of the dynamic stability, geometric performance, payload efficiency and infrastructure impact of 39 workhorse and higher capacity vehicles, using computer simulation, revealed major differences between these vehicles. The analysis indicates that, on key performance measures, higher capacity vehicles perform often better than the workhorse vehicles used to transport the majority of road freight around the world today. The data obtained from the vehicle simulations and the comparison of vehicle performance against the selected measures highlighted areas for improvement as well as good practice

#### **C.4 Netherlands**

This report documents the safety outcome of a pilot study of longer and heavier vehicles (Aarts and Honer 2010). The Netherlands introduced an initial trial of LHVs between 2001 and 2004. The authorization of LHVs was extended in a second trial period between 2004 and 2006. After a transitional period a large-scale trial was commenced on 1 November 2007. This was the first time that LHVs were introduced on such a large scale. Approximately 118 LHV companies participated during the course of this study and the trial period lasted until November 2012.

LHVs operating in the Netherlands must not transport livestock or hazardous materials and are equipped with the following extra hardware:

- A mirror kit in accordance with the latest European regulations;
- Advanced braking systems;
- An axle load measuring system;
- Side protection between the wheels;
- Side markings to ensure better visibility in the dark; and
- A sign on the back showing the contour of the combination and stating the length in meters.

The handling of the combination and the detailed operation of the vehicles are also subject to further requirements.

In addition to equipment requirements, with regard to road safety, in order to drive an LHV the driver must comply with the following three conditions;

- The driver must have at least five years of experience driving an articulated vehicle;
- The driver must possess a specific LHV certificate; and
- In the three years prior to participation in the trial, the driver may not have been disqualified from driving, have had his/her driving license revoked or been required to surrender his/her license due to an offence or crime.

The objective of this research was to make clear whether the current deployment of LHVs causes any issues in relation to road traffic safety, traffic flow and road design. The intent of the safety analysis is to gain preliminary insight into possible issues concerning LHVs in relation to traffic safety, road design and traffic flow. This insight was obtained through technical analysis of LHV accident records.

The following steps were used in the safety analysis.

1. Ascertaining accidents involving LHVs.
2. Individual (case-by-case) analysis of the crash.
3. Comparison of crash characteristics.

Each identified incident was thoroughly examined on a case-by-case basis addressing the following categories:

- Description of location;
- Description of circumstances;
- Description of accident;
- Significance of LHV characteristics; and
- Accident proneness of location.

With respect to safety the study produced the following conclusions.

Between 2007 and mid 2009 eleven accidents involving LHVs were recorded. All eleven accidents had resulted in material damage only (MDO).

Not all accidents that happen are recorded by police. Considering the high registration level of accidents involving fatalities and casualties requiring hospital treatment, there is little chance for any LHV accident involving casualties to have occurred.

Based on the accident analyses it cannot be concluded that LHVs are at a higher risk of accidents than regular trucks.

One matter of interest is the side visibility and perception of the vehicle combination. LHV drivers have the impression that other road users, upon passing or overtaking, discover too late that they are driving next to a longer vehicle. This poses a heightened safety risk in the following situations:

1. Short slip roads and slip roads that do not continue into a hard shoulder; and
2. Busy motorways with a high concentration of entry and exit lanes.

Poor weather conditions (wind and slippery roads) in combinations with limited axle pressure because of a light or small vehicle load may also bring about increased traffic safety risks for LHVs.

It is suspected that LHVs at threat of overturning are more difficult to correct than regular trucks.

Interactions with slow traffic will always bring about an increased risk to traffic safety; this is no different for LHVs than it is for regular trucks. The vast majority of potentially treacherous situations that were reported happened on the strategic road network, however. Moreover, drivers indicated they encountered little slow traffic on their routes. The designation of LHV routes may as such be deemed successful.

Current vehicle requirements appear to work well in practice, too:

- At regular police checks LHVs distinguish themselves in a positive sense; vehicle equipment is generally in good order;
- Brake power and visibility from within the an LHV (blind spot issue) is no different from regular goods vehicles or, according to drivers and experts, sometimes even better; and
- Splash guards and anti-spray mud flaps appear to work well in practice.

LHV drivers tend to cherish a great sense of responsibility and anticipate other traffic with great awareness. Separate LHV training and driver requirements contribute greatly to this. LHVs appear to adhere to the routes designated for use by these vehicles.

#### ***C.4.1 European Modular System***

In the European Union, political initiatives regarding road transport are proposed by the European Commission and decided upon by the Council of Ministers in agreement with the European Parliament. Current policies build on the White Paper “European transport policy for 2010: Time to Decide” and a mid-term review of this White Paper “Keep Europe Moving – Sustainable Mobility for our Continent”. The 27 nations of the Union are responsible for domestic policies related to truck regulation but are required to allow trucks that meet European Union standards access to their road networks.

European Modular System is a concept of allowing combinations of existing loading units (modules) into longer and sometimes heavier vehicle combinations to be used on some parts of the road network. The typical modules are 20 and 40 foot cargo containers making this vehicle highly compatible with intermodal freight movement. Because of transport challenges facing Sweden and Finland, vehicle weights were significantly higher than those in most European countries. Therefore it was impractical for Sweden and Finland to apply the EU rules on weights and dimensions as they would have reduced vehicle productivity. In order to find a solution that would enable foreign transporters to compete on equal terms in Sweden and Finland, a compromise was reached to allow increased vehicle length and weight all over the EU on the condition that the existing standardized EU modules were used. This is the so-called European Modular System.

Legislation that limits the maximum size and weight of trucks (Directive 96/53/EC) together with provisions for Combined Transport operations (Directive 92/106/EEC) were re-evaluated with the view to making more efficient use of infrastructure capacity and distribution logistics. This includes potential wider use of European Modular System vehicle combinations 25.25 meters long. These vehicles are in regular use in Sweden and Finland, with trials underway in some other member states (Netherlands, Denmark and some northern German States). In April 2013, Directive 96/53/EC was amended and provided a mechanism to facilitate wider use of EMS vehicles among cooperating countries.

Key elements of the policy on which regulatory decisions are based in the EU are:

- The principle of co-modality (the efficient use of different modes on their own and in combination) has been adopted as the approach to achieve optimal and sustainable utilization of resources;
- European-wide standardization of various conditions of road freight transport, such as driving licensing, working conditions and easing of administrative burdens;
- Establishment of national electronic registers for infringements of Community legislation for road freight transport and interconnection of these registers so as to obtain harmonization of sanctions for such infringements;

- A directive on road charging for heavy vehicles that seeks to prevent discrimination, or charging monopoly rents, by requiring charges to be based on road expenditure but which allows nations to charge some of the external costs associated with road transport in congested and polluted areas; and
- A target to produce 20% less CO<sub>2</sub> by 2020 for the EU as a whole, across all sectors of the economy, compared to a 1990 baseline.

### **C.5 Sweden**

The following is a reproduction of the summary of research focusing on the operations and safety of long combinations vehicles published by VTI, the Swedish National Road and Transport Research Institute (Hjort and Sandin 2012).

Longer and heavier vehicles on the roads could result in large transport and economic benefits. In an on-going VTI project, denoted Sammodalitetsprojektet, an economic estimate is made of the effects of allowing longer and heavier trucks in Sweden. A central part of that project is traffic safety analysis and risk assessment of longer and heavier vehicles. This review concerns potential traffic safety effects from the introduction of longer and heavier trucks than those currently allowed in Sweden.

For this purpose, a summary of results from accident studies, literature summaries and in-depth studies of fatal accidents involving heavy trucks done in the past few years was made. In addition, a focus group study with truck drivers was conducted to pick up the traffic safety problems with road transports involving the heavy trucks available today. Results from a parallel VTI study concerning overtaking of longer trucks have also been included in order to give an overall picture of the possible traffic safety effects associated with the introduction of longer and heavier trucks in Sweden.

In summary, the literature shows that it is very complex to estimate how the traffic safety in general would be affected by the introduction of longer and heavier vehicles. Some studies indicate a slightly increased risk of accidents per vehicle mile, and that the increase depends on the vehicle combination in nature. Other studies show that the difference in accident rates in comparison to conventional vehicles is small, at least for larger and safer roads. Several studies make the case that if the number of accidents per unit of transported goods is counted, there is an expected crash risk reduction with longer and heavier vehicles. Potential adverse traffic safety effects per vehicle kilometer could thus be offset by the fact that fewer vehicles are needed to transport a given amount of goods. Some studies conclude that the longer and heavier vehicles may even have a positive net effect on traffic safety. In order to estimate the overall impact on traffic safety of an introduction of longer and heavier vehicles, it is important to take into account whether the traffic volume of heavy transport will change due to the new conditions. Will, for example, the amount of transported goods increase as a direct consequence of the introduction of these vehicles? On which roads will the transports take place? How will the freight be divided across different transport modes if longer and heavier vehicles are introduced on a larger scale? These are matters outside the scope of this report. But in any case, for maintaining or achieving a net positive effect on road safety, it is essential that the longer and heavier vehicles do not significantly increase the risk of any aspect of traffic safety. Based on the aspects that have been addressed in this report, we recommend the following.

- Longer and heavier vehicles should mainly operate on main roads where it is possible to overtake heavy vehicles without fear of oncoming traffic. Longer and heavier vehicles should operate as little as possible in urban areas.
- Longer and heavier vehicles shall be constructed for good stability, and be equipped with Electronic Brake Systems (EBS), which apply different amount of brake force between the wheels to avoid wheel lock.
- Longer and heavier vehicles put greater demand on tires, brakes and especially maintenance and inspection. In that statistics from Svensk Bilprovning show deficiencies in the brake system of heavy trucks (29%) and heavy trailers (45%), it is of the utmost importance that the braking system on conventional as well as longer and heavier vehicles is checked regularly. In general, the legislation should be reviewed to see if an increased responsibility could be put on vehicle owners regarding control of brakes for all heavy vehicles.
- Driver fatigue is a significant causal factor in single-vehicle accidents involving heavy vehicles. Drive and rest times may be harder to keep with the extra-long vehicles if rest areas, which are already today overcrowded along certain roads, are not extended.
- The signs of the transition distance on 2+1 roads should be reviewed to possibly reduce the risk of dangerous situations and emergencies caused by overtaking of heavy vehicles, regardless of length. (Note: A “2+1” road is a three lane road consisting of two lanes in one direction and one lane in the other, alternating every few kilometers, and separated usually with a steel cable barrier.)
- The design or the visibility of the sign that warns of “long load” could possibly be improved in order to reduce the risk of critical situations when overtaking of heavier and longer vehicles on both 2 +1 roads and two-lane roads.
- In the literature, accident risk is usually estimated as an average over all accident categories. In order to identify in better detail which traffic situations may be affected by longer and heavier vehicles, additional studies should be carried out to estimate the risk of accidents per accident category.
- In the literature it is often mentioned that longer and heavier vehicles are likely to have a negative impact at intersections caused by the length of the vehicle and/or slower acceleration. Studies need to be conducted to determine whether this is the case.
- Frontal Collisions with oncoming vehicles when overtaking on two-lane roads results in fatal and serious injuries with significant social costs. Additional field studies on two-lane roads are therefore necessary to determine whether there is a higher risk to overtake a 30 m-long vehicle compared to overtaking a conventional heavy truck.

The following is a reproduction of the summary of research focusing on overtaking safety of long combinations vehicles published by VTI, the Swedish National Road and Transport Research Institute Summary of report (Andersson 2011).

The purpose of this report is to investigate if the introduction of extra-long and heavy vehicles has an effect on traffic safety on Swedish roads, especially in relation to overtaking. Traffic safety effects will be measured by road user behaviors in terms of speed and accelerations and

time slots. Road user experiences and heavy truck drivers' experiences will also be studied. The traffic conflict technique (Almqvist, 2006; Ekman, 1996; Hydén, 1987; Svensson, 1998) presents how time-to-collision and speed are related to accidents and near accidents. The traffic conflict technique will be used as a starting point for the discussion on how the introduction of extra-long trucks might affect traffic safety.

The report presents four empirical studies: a focus group interview study with heavy truck drivers, an interview study with extra-long truck drivers, a simulator study and a field study. The simulator study and the field study focuses on overtaking.

The purpose of the focus group interview is to investigate if the heavy truck drivers (that do not drive the extra-long trucks) might have an opinion on how extra-long vehicles could have an impact on traffic safety. The purpose of the interview of extra-long truck drivers is to grasp the experiences they have of the extra-long trucks. Truck drivers that do not drive the extra-long trucks believe that the introduction of extra-long trucks will create a number of traffic safety problems especially in terms of conflict with ordinary road users. The drivers of extra-long trucks do not experience the problems that ordinary truck drivers predict. The problems they experience can be taken care of with more planning (thinking ahead). They also believe that the traffic sign on the back of the extra-long vehicle has a positive effect. The truck company, working environment and truck equipment are other important aspects mentioned by the extra-long truck drivers [sic].

The simulator study investigates over taking situations on a 2+1-road, with extra-long trucks (30 m) and an ordinary truck (18.75 m). The results reveal that the distance from the back of the truck to the point where only one lane exists affects car drivers' decision to overtake, independently of truck length. If the back of the truck is in the same position, the time slot for a safe overtaking was reduced significantly for extra-long trucks compared to ordinary trucks. Overtaking speed was, however, the same (approximately 117 km/h).

The field study also assesses overtaking situations with an extra-long vehicle (30 m) (with a license to drive on a specific road) and a reference vehicle (24 m), on a 2+1 road and an ordinary two-lane road. Overtaking vehicles were filmed with the purpose to measure overtaking behavior but also in order to be able to contact the road users by telephone. The overtaking personal car drivers did not experience a traffic safety conflict on the road at hand. They did not even remember overtaking an extra-long vehicle. The number of data points was relatively few, especially for the reference vehicle. No significant differences were obtained for overtaking speed or time slots. The overtaking speed was, however, relatively high for both trucks. On the other hand, video analyses revealed a small overrepresentation of critical time slots for critical overtaking of the extra-long trucks on a normal road, but not for the 2+1 road.

### **A.7 Addendum to the Desk Scan – Truck Crashes Involving Barriers**

Following the submission of the draft desk scan, the FHWA subject matter experts asked the study team to review two references related to heavy truck crashes and barriers. Provided in this addendum are those reviews. The safety team is aware of the consequences of a heavy truck crash that penetrates a barrier, especially a median barrier, in which the crash results in a collision with an oncoming vehicle. As part of the proposed crash analysis, we will explore differences in the frequencies and rates of multiple collision types, including barrier-related collisions. We will document any differences in these measures between proposed truck configurations and the baseline configurations. The limitation on any collision-type analysis will likely be sample size, e.g., there may be too few truck-involved barrier-related crashes to develop definitive results. More extensive analyses may be conducted with a diagnostic review of crash reports or through the use of finite element analysis. However, pursuit of such options need to be discussed with FHWA in terms of specific objectives, likelihood of success in accomplishing those objectives, cost, and schedule.

#### ***Reference Review 1***

Gabauer, D. J., (2012), Real-World Barrier Performance of Longitudinal Barriers Struck by Large Trucks, TRR 2309, Transportation Research Board, Washington D.C., p127-134.

The authors seek to identify the performance of barriers when impacted by large trucks as measured by various crash databases including the Large Truck Crash Causation Study (LTCCS), Fatality Analysis System (FARS 2000 through 2009) and the General Estimates System (GES for years 2000 through 2009). Among the metrics used are: barrier crash and fatal crash involvement rates and the impact performance of barriers specifically designed for large trucks and those not designed for large trucks. Different search criteria are used in each database to identify the relevant crashes to be used for analysis. The criteria used to identify barrier crashes may be of interest to the team in identifying the sample size of barrier-related events in our data sets. Exposure data were drawn from annual summaries provided by FHWA.

The databases used were adequate for the analyses undertaken by Dr. Gabauer, but contain insufficient detail for use in the current CTSWL study to assess the crash experience of specific vehicle configurations at different weights. The crash data used in this study (with the exception of LTCCS) does not contain vehicle configuration or weight data.

The focus is on barrier performance but vehicle weight and length are not explicitly included in the analysis. Barrier penetration was assessed using a dichotomous variable: 1 if penetrated and 0 if not. LTCCS analyses aggregated vehicle type in two classes: single unit and tractor-trailer. A logistic regression was used with LTCCS data to estimate the proportion of barriers penetrated. Barrier type was the only predictor of stated significance (see **Table 6** in reference). This modeling is described in a summary manner and important measures of model performance such as the receiver operating characteristic curve are not included.

Crash and fatality rates were computed per year for single-unit trucks and tractor semitrailers and compared with light trucks and vans and cars (and motorcycles). The use of crash rates measured



over time, while interesting, does not provide keen insights concerning *vehicle* performance differences, which are of relevance to the CTSW team.

For the purposes of the CTSWL study, the results of this paper are of limited use. The truck descriptions are at a level of aggregation that does not permit identification of even baseline vehicles, let alone future configurations. So the study is useful in general, but does not provide the specificity needed to contribute quantitatively to the CTSWL study.

### ***Reference Review 2***

Knipling, RR, P Waller, RC Peck, R Pfefer, TR Neuman, KL Slack, and KK Hardy, (2004), NCHRP 500, volume 13, A Guide for Reducing Collisions Involving Heavy Trucks, Transportation research Board, Washington, D.C.,

The goal of the NCHRP 500 series is to reduce highway deaths. Volume 13 of the series focuses on countermeasures to reduce large truck involvement in these fatalities. To reduce the number of heavy-truck fatality crashes, the study recommends actions including the following:

- Reduce truck driver fatigue
- Strengthen commercial driver's license (CDL) requirements and enforcement
- Increase public knowledge about sharing the road
- Improve maintenance of heavy trucks
- Identify and correct unsafe roadway and operational characteristics
- Improve and enhance truck safety data
- Promote industry safety initiatives

The focus of the volume is clearly on countermeasures and particularly on countermeasures that have already been implemented. As such, it is not directly related to the safety of larger and heavier vehicles. In a detailed description of the problem, however, truck weight is specifically mentioned in terms of the disparity between the weight of trucks involved in fatal crashes (from one study over half weighed in excess of 60,000lb) and the weight of passenger vehicles (given as typically less than 5,000lb).

A set of strategies (**Objective 12.1E** in the reference) are proposed that seek to identify and correct unsafe roadway infrastructure and operational characteristics. These roadway strategies are stated as being focused on impacting the speed of trucks or overcome loss of control due to excessive speed (Page V-38 of report). Barriers, particularly those designed for heavy trucks are specifically mentioned as a countermeasure to reduce heavy vehicle road departures, particularly to the left of the road.

## APPENDIX B. SAFETY PROJECT PLAN AND SCHEDULE

### **B.1 General Approach**

This document presents the safety comparative analysis final draft project plan for the Safety Work Area of the *Comprehensive Truck Size & Weight Limits Study (CTS&WLS)*. The Final Draft Project Plan/Schedule presents the methodology for the completing the safety analysis area of the Study.

The overall approach to the analysis includes four components:

- Desk Scan
- Analysis of Truck Crash Data
- Analysis of Vehicle Stability and Control
- Analysis of Safety Inspections and Violations

The specifics for each of these components are described in the remainder of this plan.

### **B.2 Desk Scan**

A comprehensive investigation was conducted on studies and research in the area of truck safety related to truck size and weight policy. It included relevant truck size and weight reports, safety technologies that may improve heavy truck safety performance, notable international activities and an investigation of the availability and potential usefulness of trucking industry fleet data to support a fleet level analysis focusing on the influence of increased gross vehicle weight (GVW) and configuration variation on safety performance. The latest version of the Draft Desk Scan was made available to the public on the Project Website in November, 2013.

### **B.3 Analysis of Truck Crash Data**

The goal of the crash data analysis is to predict the level of safety for *alternative truck configurations* and compare that level of safety to *baseline (reference) truck configurations*.

Recall that the two baseline vehicles and six future configurations to be studied are:

- Five Axle, Tractor-Semitrailer Combination (3-S2), 80,000 pounds (Reference configuration) – The “standard” configuration of a three-axle tractor with a 53-ft., two-axle semitrailer and a GVW of 80,000 pounds.
- 3-S2, 88,000 pounds – The same tractor-semitrailer configuration, but with a GVW of 88,000 pounds.
- Six axle, Tractor-Semi-trailer Combination (3-S3), 97,000 pounds– A tractor-semitrailer configuration with a three-axle tractor and a three-axle semitrailer and a GVW of 97,000 pounds.
- Six axle, Tractor-Semi-trailer Combination (3-S3), 91,000 pounds – A tractor-semitrailer configuration that meets the Federal Bridge Formula with a three-axle tractor and a three-axle semitrailer and a GVW of 91,000 pounds.

- Twin 28.5 foot, 80,000 pounds (Reference configuration) – The current “standard” configuration of a tractor and two “twin” trailers, each 28.5 ft. long, and a GVW of 80,000 pounds.
- Twin 33 foot, 80,000 pounds – A twin configuration with two twin trailers, each 33 foot long and a GVW of 80,000 pounds
- Triple 28.5 foot, 105,000 pounds – A triple-trailer configuration with three 28.5 foot trailers and a GVW of 105,000 pounds.
- Triple 28.5 foot, 129,000 pounds – The triple-trailer configuration with three 28.5 foot trailers and a GVW of 129,000 pounds.

The level of safety is to be measured by crash rates for the different configurations. Obviously, such comparisons can only be made with data from trucks that are currently legally operating over the limit. Hence, the twin 33-ft. vehicles cannot be evaluated using crash data since they are not currently on the road.

Three possible methods for doing these comparisons will be conducted. One approach, by itself, will not provide the insights and answers that we are seeking regarding the safety of alternative configurations. A preliminary examination of the extent of the data available has been completed, including State crash data, traffic volumes, and fleet data. Once data has been compiled from the carriers and the States, the method(s) that offers the best chance of meeting the study objectives will be identified and developed. Other methods will be considered as offered through stakeholder outreach; such methods are not discussed in this document. As documented in the method descriptions that follow, the challenge for any method to be successful is the availability of crash data and exposure data for the target (future) and baseline (reference) truck configurations.

The first method is called as the route-based method: this route-based method compares the safety of routes that operate future configuration trucks and routes that operate baseline (reference) configurations. The second method is called as the fleet-based method, where the goal is to compare the crash history of baseline configuration trucks and future configuration trucks that are operated by the same carrier – the crash and exposure data from the carriers along with traffic volume (AADT) will be used for this analysis. The third method is the analysis of crash rates using State-based crash data. Following is further discussion about our thinking on the three methods.

### **Method 1: Route-Based Method**

In order to do the comparison of crash rates, data is needed for crashes involving trucks and exposure by truck configuration (*i.e.*, vehicle miles by truck configuration). Since the configurations involve differences in weight (either actual or registered gross weight), number of trailers (singles, doubles, triples), and length of individual trailers, ideally, both the crash and exposure data should include this information. Crash report forms from all 50 States have been

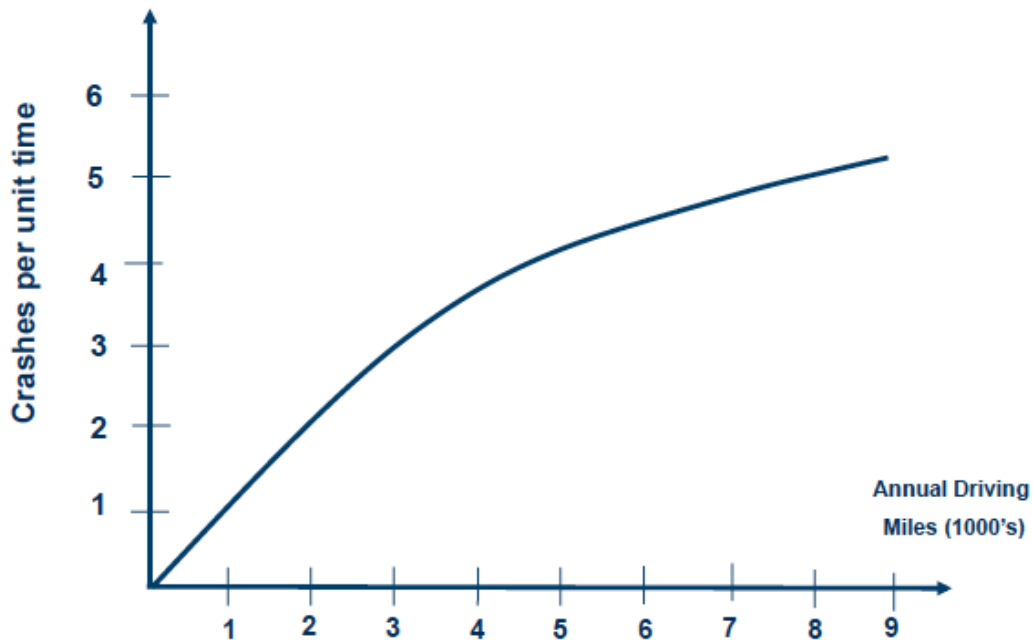
reviewed. The goal of the review was to determine the availability of data from truck-related elements needed for our analysis – configuration, axles, length, and weight. Number of trailers and axles are available in the crash reports in many of the States. Length of trailers is available in a few States. For exposure, data from Weigh-in-Motion (WIM) stations and classification counts from permanent count stations can be used – these data sets have been used in previous studies to estimate the exposure of longer combination vehicles (*e.g.*, Abdel-Rahim *et al.*, 2006a; 2006b). Since the WIM stations are located predominantly on freeways and interstates, the main focus will be on these types of roadways.

The proposed analysis approach will involve the comparison of the safety performance of roadway segments and routes that operate trucks with the baseline configuration and those that operate trucks that belong to the future configurations (*e.g.*, triples, heavier semitrailers and doubles). It should be emphasized that this procedure compares *routes*, not specific truck types. This is a less than desirable comparison but one that we feel will contribute knowledge to the results obtained from the other methods. The analysis will involve the following steps:

- Identify States with that allow future configuration trucks on certain routes, but do not allow future configuration trucks on other similar routes.
- Identify the specific routes and/or segments that operate future configuration trucks. The data from the WIM stations along with information from the States will be used to identify these routes and segments.
- Identify similar routes and/or segments that do not allow future configuration trucks. For each route and/or segment identified that allows future configuration trucks, we will seek to identify similar routes and segments that do not allow future configuration trucks (*i.e.*, baseline routes). Again the data from the WIM stations will be used for this purpose. Factors such as traffic volume (AADT), area type (rural versus urban), overall truck percentage, number of lanes, and terrain, will be used to determine which segments are similar (most of this data about the routes and segments can be obtained from State Departments of Transportation (DOT); for Highway Safety Information System (HSIS) States. In some States, it may be difficult to identify a sufficient number of such segments. For example, all or most of the freeway/interstate routes may allow future configuration trucks. In that case, the routes and segments will be divided based on the proportion of future configuration trucks, (*e.g.*, <5 percent, 5-10 percent, and more than 10 percent), and the routes and segments with lowest proportion of future configuration trucks will be considered as the baseline routes/segments.
- Estimate Safety Performance Functions (SPFs) using data from baseline routes and segments. SPFs are *functions* that relate the expected number of crashes to a measure of exposure (*e.g.*, driving miles). SPFs explicitly recognize the fact that the relationship between crash frequency and exposure may not always be linear. Typically when SPFs are a *function* that relates the expected number of crashes to a measure of exposure (*e.g.*, driving miles). **Figure 1** is an example of the type of relationship often found between crash frequency and exposure. The SPF replaces, in a general way, the concept of the

crash rate. If needed, the crash rate can be derived directly from the SPF as the slope of the line from the origin to the point of interest on the curve. The literature (Hauer, 1995) presents a description of the advantages of this approach and it is widely accepted by the road safety community.

**Figure 1. Example Safety Performance Function**



- The current state of the art is to use negative binomial regression to estimate the SPFs. The dependent variable will be the expected number of truck involvements in crashes in a particular segment. SPFs will be estimated for total truck crashes, and fatal and injury truck crashes; separate SPFs may be needed by time of day as well. The independent variables for this SPF will include traffic volume, overall truck percentage, area type (rural versus urban), number of lanes, terrain, whether a particular segment is within the influence of an interchange, and/or the number of interchanges within a section.
- Estimate the expected number of truck crashes in routes that allow future configuration trucks. Using the SPFs that are estimated in Step 4, and the characteristics of the routes that allow future configuration trucks, predict the number of the truck crashes in the routes that allow future configuration trucks. Estimate the expected number of crashes on these routes using the Empirical Bayes (EB) method (AASHTO, 2010). (This is the expected number of crashes on the routes that allow future configurations had these routes not allowed the future configuration trucks.)
- Compare the actual number of total truck crashes on the routes with future configuration trucks with the expected number of total truck crashes. The goal of this comparison is to determine if the reported number of truck crashes in the routes with future configuration

trucks is significantly different from the expected number of truck crashes. This comparison will provide insight into whether the routes that allow future configuration trucks are associated with a higher/lower rate of crashes compared to routes that operate within the baseline.

It is important to note that the EB method has traditionally been used for before-after studies to determine the safety of engineering treatments (AASHTO, 2010). However, it is not within the scope of this Study to conduct a before-after study. As discussed above, this method will be adapted to obtain insight into whether routes that allow future configuration trucks are associated with a higher/lower rate of crashes compared to routes that allow only the baseline configurations. Further details about this approach are available from Bonneson and Pratt (2008).

An alternative approach is to combine the data from the baseline and routes with future configurations and estimate SPFs by including the percentage of alternative truck configurations trucks (based on the WIM data) as an independent variable (in addition to the other independent variables mentioned earlier). If the percentage of future configuration trucks is statistically significant, then findings can be identified as to whether the alternative truck configurations are associated with a higher/lower rate of crashes compared to trucks that operate within the baseline. If data are available, the possibility of categorizing the future configuration trucks into a range of weights can be explored and an assessment of the individual safety performance of the different weight categories may be possible.

An initial review has identified Ohio, Indiana, Maine, and Louisiana as possible candidates for this method. In Ohio and Indiana, triples are allowed on interstate toll roads, but not on other Interstates. So, in these two States, non-toll Interstate routes will be the 'baseline.' In Maine, heavier semitrailer trucks (more than 80,000 pounds) have been allowed on the Maine interstate turnpikes since 2008, but not on other interstates until 2013. So, similar to Ohio and Indiana, in Maine, the 'baseline' can include non-turnpike interstates. In Louisiana, heavier semitrailer trucks are allowed on interstates during the 100-day harvest season to accommodate the transport of sugarcane. Hence, for this State, the 'baseline' will be the Interstate roads during the non-harvest months. To the extent possible, the analysis will account for the differences between the summer and non-summer months by including traffic volume data (by month) from permanent count stations in the State and the WIM data, and by examining wet weather and dry weather crashes separately, and day and night crashes separately.

Efforts will continue to identify States that could be possible candidates for this method. Permitting offices in many States have been contacted and will efforts in reaching out will continue to help identify potential routes. Enforcement agencies in the States will be contacted as well; it is expected that enforcement agencies have insights on where various configurations are traveling. Finally, an evaluation of the availability and coverage of roadway segments where WIM data is being or has been collected is underway to determine the level of exposure data that

are available for this area of the analysis, including the location of specific WIM stations on routes of interest. As part of the decision-making process, the extent of the mileage available in each State where reference trucks are traveling will be taken into account. It is recognized that the mileage available in some States is limited, and that care must be taken when attempting to extrapolate the results from these locations to a more extensive network of roadways. At the same time, selections will be limited by the locations where the reference configurations are presently operating.

### **Method 2: Fleet-Based Method**

The availability of fleet data is being explored for use in the safety analysis in the CTS&WLS. Discussions have been conducted with the American Trucking Associations (ATA) and the American Transportation Research Institute (ATRI) in order to explore the possibility of accessing and using trucking company based information to supplement truck crash information and data available through public sector sources. For example, carrier contacts were established and are being pursued for crash and operations data reflecting triples operations and legal divisible heavy trucks (*i.e.*, those regularly operating over 80,000 pounds). Two types of analyses are proposed: 1) a comparison of triples safety (*i.e.*, three 28.5 foot trailers) compared to doubles (two 28.5 foot trailers) and 2) a comparison of the heavy legal vehicles compared to a 3-S2 80,000 pounds configuration. Additional private sector based truck crash data and operations may be pursued where critical gaps are noted in building the data sets required to complete the work in the area of the Project.

There are important commonalities in these analyses. Crash data will consist of USDOT-reportable crashes as these are most consistently reported and known to USDOT regulators; discussions with all trucking industry representatives indicate that this is a reasonable request. Exposure to risk data will be needed for all routes in question; this will be either number of dispatches or vehicle miles traveled. It is important that we obtain data on road segments with operations that result in zero crashes in a year as well as those with crash events. The preferred analysis approach is to use the SPF-based methods as described in method one. Where data are not available to use the Highway Safety Manual (HSM) methods, a comparison of mean crash rates will be undertaken.

In the Study application Method 2, the SPF will be developed from the crash and exposure data for baseline vehicles provided by carriers. It is likely that exposure from general traffic level as a covariate will need to be added. The effect of future vehicles will be estimated by comparing the crashes experienced with the future vehicles compared to the SPF developed from baseline vehicles using negative binomial regression. This is the basic formulation to be pursued; other options will be explored within the limitations of available data.

### Data Request and Data Custody

The data requests for legal divisible heavy trucks and triples analysis have been developed. The basic data elements requested from both groups of carriers include:

- Date of crash – would prefer historical data back to 2006 if possible.
- Time of Day
- Location of crash (street address; interstate highway; State route number and milepost or other location reference).
- State
- Gross Vehicle Weight
- Axle based weight
- Number of axles
- Axle spacings
- Number injured in truck
- Number injured in other involved vehicle
- Number killed in truck
- Number killed in other involved vehicle
- Truck driver age
- Truck driver experience with firm
- Type of collision
  - Truck rear-ending passenger vehicle
  - Passenger vehicle rear ending truck
  - Truck crossing center median (head on)
  - Passenger vehicle crossing center median (head on)
  - Truck striking passenger vehicle (other)
  - Passenger vehicle striking truck (other)
  - Truck single-vehicle crash
- Driver-related factors in crash
- Vehicle-related factors in crash
- Roadway/weather related factors in crash
- Seat belt use
  - Truck driver
  - Passenger vehicle driver and passengers
- Driver and vehicle violations - truck
- Driver-related factors - passenger car

Requests for these data have been transmitted directly to carriers. Responses from the carriers are currently pending at this time. A data use agreement and data custody policy has been crafted. Both are aimed at protecting the confidentiality of the carrier and their data, by assuring that access to and use of the raw data will be restricted. **Figure 2** shows the data custody guideline



proposed for use with carrier data. Note that the carrier data (item 2 in Data/Model Access section) will be subject to limited access and availability. In addition, the identity of participating carriers will be shielded using several methods: aggregating analysis results; using letters or other acronyms for locations (if potentially revealing); or, other techniques as required.

Analysis of vehicle crash experience for over-80,000 pounds trucks

Obtaining fleet data for heavy truck operations has proven more challenging than for triples. Additional discussions with the ATA and ATRI have led to the need to approach industry through the State-level ATA's. Both industry organizations agree that the users of these heavier legal trucks are dispersed across the industry as well as geographically. A project description was prepared for communication with the industry and was delivered to ATRI. Current indications are that 10-12 carriers are considering participation in the analysis of heavy divisible load vehicles. More definitive commitments are expected very soon.

One aspect of the comparison is that there is a range of these legal heavy vehicles operating in different States: 85,000 pounds, 88,000 pounds, and 90,000 pounds. Separate comparisons for each of these three weights will be conducted. It is likely that the data will need to be pooled together as there may not be a sufficient sample size of each weight class to conduct separate analyses.

**Figure 2. CTS&WLS Data/Model Accessibility and Data Custody Guidelines**

|  |   |
|--|---|
| <b>Data/Model Accessibility Guidelines</b> | <ol style="list-style-type: none"> <li>1) <b>In Summary</b> - The CTS&amp;WLS data/models used to conduct analysis will be available to USDOT and third parties by following the requirement “can the data/model be made available”. The availability of some data/models may have specific requirements: usage agreement specific to the Study only, usage fee to vendor, and compliance with a Non-Disclosure Agreement (NDA) or Data Agreement (DA).</li> <li>2) <b>Safety Carrier Data</b> - Proprietary individual carrier safety data will be available to the Study under a NDA/DA and will not be available to other third parties. Individual carrier data will be blended for use in the safety analysis. This blended database will be available to other third parties, per the NDAs/DAs’ requirements enabling independent verification of the analysis by interested third parties.</li> <li>3) <b>Truck Flow Data</b> - The truck flow data used in the Study will be a county-to-county disaggregation of the Freight Analysis Framework database; disaggregation methods will be shared with third parties so that the data set can be recreated.</li> <li>4) <b>Vehicle Stability and Control Model</b> - The vehicle stability and control (VSC) analysis will use the commercially available TruckSIM<sup>®</sup> model. The TruckSIM model is available to third parties for a fee with a NDA/DA. A second VSC model, NTRCI Triple Trailer, will be used in VSC analysis. This NTRCI model is a proprietary model and can be made available to third parties for a usage fee with a NDA/DA.</li> <li>5) <b>Pavement Analysis Model</b> – The pavement cost analysis task will use the</li> </ol> |
|--|---|

|                                       |   |
|---------------------------------------|---|
|                                       | <p><i>AASHTOWare Pavement ME Design</i><sup>®</sup> model, which is commercially available for an annual license fee.</p> <p>6) <b>Confidential Waybill Sample</b> – If rail flow data from the Surface Transportation Board’s (STB) confidential waybill sample is used for the rail traffic impact analysis, STB’s standard NDA governing the restricted use of the data will apply. This data will be acquired with USDOT FRA’s cooperation. Third parties will have to request data from the STB.</p> <p>7) <b>Truck Cost Data</b> – The truck cost data used in the Study will be made available to interested third parties via a NDA/DA. This proprietary data base will include access by third party via the NDA/DA.</p> |
| <p><b>Data Custody Guidelines</b></p> | <p>1) <b>Safety Carrier Data</b> – Proprietary individual carrier safety data will have an established and documented path of communication and control between the carrier and personnel engaged in this part of the Study. Custody of the carrier data will be managed per a NDA/DA. Direct transfer of the individual carrier data between the carrier and the personnel involved in this part of the Study will be enabled.</p> <p>2) <b>Truck Cost Data</b> – The NDA/DA and contract will limit the usage of the data for Study purposes only.</p>  |

The purpose of this portion of the fleet-level analysis is to evaluate the relative safety of heavy divisible load vehicles in practice. The fleet-level analysis will be a comparison within carriers that operate more than one of the alternative configurations. The analysis approach uses a paired comparison method in which route-specific crash frequencies and rates are compared for the same firm operating on different routes. The number of dispatches of each vehicle type along each specific route in a year is used to estimate vehicle miles traveled, and a matched-pair comparison of means is used to compare rate differences for the baseline and comparison vehicles operated by the same company on the each route. This approach indicates the risk to all travelers of having each vehicle operate. The travel will be checked to see if it is occurring at similar times, months, etc.; the preliminary finding is that this seems like a feasible approach. If the heavy vehicles are limited to truckload operations, then we need to look for “lanes” commonly used to route the vehicles to customers.

Specific steps in the analysis include:

1. Obtain agreement with 3-4 truck fleets that operate both legal divisible heavy vehicles and 80,000 pounds comparable vehicles (3-S2). Carriers with geographically distributed operations and a range of sizes are ideally suited for this having this data.
2. Identify and obtain crash and exposure data from the fleets that operate both baseline and alternative configurations.
3. Process data to determine the types of analyses that can be performed, including related factors that affect safety outcomes, such as driver tenure, crash avoidance and other vehicle-based technologies.
4. Perform appropriate paired-comparison statistical analysis (Jovanis, *et al.*, 1990).

5. Compare crash frequency and severity distributions within each fleet for the crashes of trucks that operate within the 80,000 pounds limit and trucks that operate legally over the 80,000 pounds limit.

An alternative method to the matched-pair approach is to use the HSM formulation in which the road baseline vehicle AADT is used as the basic measure of exposure and then the company's divisible heavy vehicle crash experience and AADT are added as "after treatment" observations. This formulation will indicate if the divisible load heavy vehicles have a higher expected number of crashes than the 80,000 pounds AADT. When permitted by the data, level of severity and crashes by type will also be analyzed by building SPF using crashes of different types.

*Status of legal divisible heavy truck data analysis with fleet data.* Some commitments from carriers have been received; it is expected that additional commitments will be made during the next few weeks. The data use agreement and data requirements have already been sent to carriers. Once contact is established with an individual firm, access to crash and operations data will be pursued; it is expected that this will occur during the months of November and December, 2013. To the extent possible, crash information will be verified by secondary sources. To date, two firms have indicated a willingness to provide data for this portion of the Study and one has returned a signed data sharing agreement.

### Approach to triples safety analysis using fleet data

Contact has been established with four carriers. Early discussions with these carriers gave the consistent message that carriers using triples operate an overwhelming proportion of triples on routes where they are allowed (because of the operational efficiencies), so twin trailer mileage on these routes is very low, and consequently crashes are few. As a result, the paired-comparison method is not feasible for triples analysis. An alternative plan to work around the problem has been discussed with the fleets. This approach is to obtain doubles crash and operations data for other routes in each carrier's operating environment nationwide. Care would be taken to obtain match routes for doubles operations that are comparable to those of triples. Crash data as well as miles traveled (or number of dispatches) is being pursued for each route traveled by the triples. It is important to obtain data on as many routes as possible, including those with zero crashes. The triples crash experience would be compared to those of doubles on these "comparable routes." The technique is similar to the approach discussed for comparing routes with and without the heavy divisible load trucks) using the HSM approach. The comparison sites (*i.e.*, the routes with the doubles) would be used to build SPFs; the actual experience of the triples operations would be compared to these sites. This comparison takes advantage of the fact that the range of error about the SPF is known and can be compared to the data for the triples as one would do in a comparison of differences between means.

Specific steps in the analysis include:

1. Seek agreements with 2-4 carriers operating triples that are willing to share their crash and operations data. The operations data, specific routes and times of day of triples dispatch, will be used to identify comparable doubles road segments.
2. Use carrier-supplied data to match routes of operation for triples with comparable routes for doubles. State-level data will be used to identify road segments used by twin trailer combinations across the country that are reasonably comparable to those used for the triples. The crash experience for double trailer combinations of the fleets will be obtained for these additional national-scale road segments.
3. Particular attention will be paid to traffic levels of personal vehicles (those other than trucks) so that appropriate comparisons can be made of crash risk. If possible, two - three road segments used by double trailer combinations will be used for comparison with each segment used by triple-trailer combinations in order to develop satisfactory precision for the analysis. It is possible that some carriers may be operating triples over the same Interstate routes in the west; these overlapping operations will be considered in the analysis.
4. Identify and obtain crash and exposure data from the fleets that operate both triple trailer and baseline twin-trailer configurations and build the needed SPFs from the double trailer combination's operations.
5. Perform appropriate statistical analysis, depending on the type and detail of crash and exposure data available. If the SPF comparison is not possible, then crash rates will be used.
6. To the extent possible with the obtained fleet doubles records, compare crash severity distributions for triples and doubles.

*Status of triples data analysis with fleet data.* Direct communications with carrier safety personnel has been established to describe the details of the Study data needs. One carrier has supplied some crash data and is assembling additional data consistent with a signed data sharing agreement. Clarification of the status of the other three that were already contacted is being pursued and steps have been taken to reach out to an additional two carriers.

### **Method 3: State Crash Rate Analysis**

Both the fleet-based and the route-based methods are aimed at comparing the crash-based level of safety for future truck configurations with current baseline trucks. Depending on the level of detail and amount of data available for both these methods, difficulties may be encountered in developing estimates of crash increases or decreases for each individual future truck configuration of interest. In an attempt to develop specific safety estimates for each future configuration, attempts will be made to conduct analyses based on crash and exposure data from individual States.

The basic method here will be to:

- Identify States in which individual future configurations can be identified through the use of variables in the existing crash data;
- Identify the subset of these States where information is available from State DOT staff and/or trucking fleets concerning which individual future configurations have accumulated adequate annual VMT to result in a reasonable sample size of crashes (*i.e.*, which future configurations have accumulated significant exposure in which State);
- Work with those State DOTs to identify specific routes or route sections on which large numbers of *both* the alternative truck configurations and current baseline trucks (*i.e.*, 53-ft., 80,000-lb. semitrailers and twin 28-ft. trailers) operate;
- Obtain total AADT for each route study section;
- Obtain WIM data for those routes and combine with the AADTs to develop VMT estimates for each baseline and alternative truck configuration, and
- Estimate safety performance functions (discussed in Method 1 section) to compare the safety of baseline trucks and alternative truck configurations.

The remainder of this section concerns the first step above – the identification of States with sufficient VMT for the truck configurations to be studied in which adequately detailed truck descriptors are included on their crash report forms. Recall that the two reference (baseline) vehicles and six alternative truck configurations to be studied are:

- 3-S2, 80,000 pounds (Reference configuration) – The “standard” configuration of a three-axle tractor with a 53 ft two-axle semitrailer and a GVW of 80,000 pounds.
- 3-S2, 88,000 pounds – The same tractor-semitrailer configuration, but with a GVW of 88,000 pounds.
- 3-S3, 97,000 pounds – A tractor-semitrailer configuration with a three-axle tractor and a three axle semitrailer and a GVW of 97,000 pounds.
- 3-S3, 91,000 pounds – A tractor-semitrailer configuration with a three-axle tractor and a three axle semitrailer and a GVW of 91,000 pounds that complies with the Federal Bridge Formula.
- Twin 28.5 ft, 80,000 pounds (Reference configuration) – The current “standard” configuration of a tractor and two “twin” trailers, each 28.5 ft long, and a GVW of 80,000 pounds.
- Twin 33 ft, 80,000 pounds – A twin configuration with two twin trailers, each 33 ft long and a GVW of 80,000 pounds.
- Triple 28.5 ft, 105,000 pounds – A triple-trailer configuration with three 28.5 ft trailers and a GVW of 105,000 pounds.
- Triple 28.5 ft, 129,000 pounds – The triple-trailer configuration with three 28.5 ft trailers and a GVW of 129,000 pounds.

In order to conduct the Method 3 crash analysis, States must be identified in which the following are true:

- There is significant VMT for both one or more alternative truck configurations and the pertinent reference vehicle – *e.g.*, sufficient triples VMT and sufficient twin 28.5 ft, 80,000 pounds VMT. (Note that there will be adequate exposure data for the reference vehicles in all States.)
- In the crash data, the reference vehicle can be distinguished from each of the alternative truck configurations and the alternative truck configurations can be distinguished from each other (*e.g.*, if both 105,000 pounds and 129,000 pounds triples are operating in the same State). This separation has to be done using only number of trailers and number of total axles, since none of the States has “actual” weight information on the crash report forms. Many of the States have fields for reporting the GVWR, but we have not discovered any States of interest to date that are actually recording the actual loaded weight of the truck.

The 3-S2, 88,000 pounds configuration will be examined by looking at States which allow 90,000 pound intermodal container chassis combinations. These intermodal container chassis combinations may be easily discernible by looking at accident records and FMCSA database coding schemes allow easy analysis of roadside vehicle inspection data for intermodal container chassis.

It may not be possible to conduct an empirical analysis the two twin 33 ft configurations. The twin 33 foot configurations have never been operated in the United States; discussion continues as to whether the twin trailer STAA control vehicle can be used as a suitable surrogate.

Maintenance and inspection records and information on the twin 28 foot trailer combination may be useful in the comparative assessment of the twin 33 trailer combination for example. Thus, the following discussion will only concern identifying States where analyses for the tractor-semitrailer configuration or the two triple configurations can be conducted (*i.e.*, (1) the 3-S2, 80,000 pounds reference vehicle can be compared to the 3-S3, 97,000 pounds future vehicle, and/or (2) the twin 28.5 ft, 80,000 pounds reference vehicle can be compared to the triple 28.5 ft, 105,000 pounds vehicle and to the triple 28.5 ft, 129,000 pounds vehicle). The decisions are based on different data inputs for the two different future vehicle types. The following text provides details for each.

#### Analysis of Triples

The inputs to the decision concerning which States will be used to compare the reference twin to the two triple configurations were from the following sources:

- A table listing States allowing triples under the ISTEAFreeze is based on data extracted from the Title 23 Code of Federal Regulations, Part 658, Appendix C. For each of the 17 States allowing triples, the table provided information on “Allowable Length - Cargo Carrying Units (feet)” and “Gross Vehicle Weight Limit (pounds)”.

- 2008 VMT data for each of 25 vehicle configurations for each of 14 functional classes within each State has been developed.
- Presence of “number of trailers” and “number of total axles” variables on State crash report forms. This information was compiled through searches for crash report forms from internet sources.

The results of this combination of data are shown in **Table 1**. Each item is explained below.

Since significant VMT of triples is critical to this analysis, the 2008 VMT data were searched to identify triples States with VMT for either or both seven axle triple-trailer combinations (TS7) and eight or more axle triple-trailer combinations (TS8+) configurations. The triples VMT levels for each State was then categorized as either very low, low, medium or high by functional class (mainly rural and urban interstates, as expected). In addition, for these same triples States, similar VMT information was extracted for each doubles category (*i.e.*, VMT for double trailer combinations with five axles (DS5), double trailer combinations with six axles (DS6), double trailer combinations with seven axles (DS7), and double trailer combinations with eight axles (DS8) since the first two are potential reference vehicles. Note that the use of 2008 VMT is suitable since the analysis will include crash data from 2008 – 2012, and a verification of triples use was needed for the full period.

Finally, information on the presence of crash form variables related to number of trailers and number of axles were added to the table for each triples State. Again, the axle count information is critical in the separation of data for the 28.5 ft, 80,000 pounds twin configuration from data for the heavier doubles configuration. Initially, it was hoped that the axles count could also separate the triples into the two weight categories – *i.e.*, that the 7-axle triples would be more likely to have 105,500 pounds GVW and the 8+ axle triples would be more likely to have 129,000 pounds GVW. However, after further discussions, it was indicated that this was not likely to be the case – that the number of axles on triples is not a good indicator of maximum GVW. For that reason, the attempt to analyze the crash experience of the two target GVW classes will be accomplished by using States with different GVW limits. That is, the sample of States to be studied will include both ones with a 105,500 pounds GVW limit and ones with a 129,000 pounds GVW limit.

Conclusions concerning the suitability for use in the analysis for each of the triples States are shown in the final column. In summary, as noted above, the primary three criteria a State should meet in order to allow a sound analysis of triples are:

- High VMT for triples
- Ability to limit the reference group to 28.5 ft, 80,000 pounds twin-trailer configuration. This can be done by using an axle count variable on the crash form or if the VMTs for DS5 and DS6 or much higher than the VMTs for DS7, DS8 and DS9.
- A GVW limit that matches the two possible future configurations -- 105,500 pounds and 129,000 pounds triples.

While none of the States allowing triples fit all three criteria, at this point it appears that the best States are as follows:

- 105,500 pounds triples
  - Idaho – Even though the triples VMT is not high, the reference group will be sound. Crash data for 2010 and earlier will be used.
  - Oregon – Less acceptable than Idaho. Even though matching the 105,000 pounds GVW limit and having very high triples VMT, the reference group cannot be limited to the target DS5 and DS6 configurations.
  
- 129,000 pounds triples
  - Kansas – Even though the 120,000 pounds GVW limit is less than the 129,000 pounds target, it is acceptable due to the higher triples VMT and the ability to develop a sound reference group.
  - Nevada – Less acceptable than Kansas. While the GVW limit matches the target 129,000 pounds and there appears to be adequate triples VMT, the reference group cannot be limited to the target DS5 and DS6 configurations.
  - Utah – Less acceptable than Kansas. Like Nevada, while the GVW limit matches the target 129,000 pounds and there appears to be adequate triples VMT, the reference group cannot be limited to the target DS5 and DS6 configurations.



**Table 1. VMT, axle data availability, gross vehicle weight (GVW) limit and conclusions concerning analysis suitability for 17 States allowing triples use.**

| State | 2008 VMT estimates                |  |                                | Crash Report Axle Data? | GVW Limit (from FHWA list)              | Conclusions  |
|-------|-----------------------------------|--|--------------------------------|-------------------------|---|--|
|       | TS7                               | TS8+                                   | Reference group                |                         |   |  |
| AK    | No VMT                            | No VMT                                 | Very low DS6 only              | No                      | Unlimited                               | No – No triples VMT, low reference group VMT, and unlimited GVW limit doesn't match future configurations.   |
| AZ    | No VMT                            | Very low VMT only on rural interstates | Med DS5 and DS6. No DS7, DS8   | No                      | 123,500 pounds (129,000 pounds on I-29) | No – No triples VMT.   |
| CO    | Low – urban and rural interstates | Low – urban and rural interstates      | High DS5 and DS6. Few DS7, DS8 | Yes                     | 110,000 pounds                          | Low-Medium priority – Low triples VMTs. Good reference group. GVW doesn't match future configurations, but 110,000 pounds is close to 105,500 pounds           |
| IA    | No VMT                            | No VMT                                 | High DS5, DS6. Very low DS7    | Yes                     | 129,000 pounds                          | No – No triples VMT shown  |
| ID    | Low – urban and rural interstates | Low – urban and rural interstates      | Low DS5, DS6, DS8. Med DS7     | Yes through 2010        | 105,500 pounds                          | Medium High priority – Medium-low triples VMT. Good reference group through 2010. Matches 105,000 pounds GVW.  |
| IN    | No VMT                            | No VMT                                 | High DS5, no DS6, DS7, DS8     | Yes                     | 127,400 pounds                          | No – No triples VMT shown.   |
| KS    | Med – mainly rural interstates    | Low – mainly rural interstates         | High DS5, DS6. Low DS7, DS8    | Yes                     | 120,000 pounds                          | Low-Medium priority – Med triples VMT and sound reference group. GVW limit doesn't match future configurations, but 120,000 pounds is close to 129,000 pounds. |

Highway Safety and Truck Crash Comparative Analysis Technical Report

| State | 2008 VMT estimates                   |                                      |   | Crash Report Axle Data? | GVW Limit (from FHWA list)       | Conclusions   |
|-------|--------------------------------------|--------------------------------------|---|-------------------------|----------------------------------|---|
|       | TS7                                  | TS8+                                 | Reference group                             |                         |                                  |   |
| MO    | No VMT                               | No VMT                               | High DS5, DS6.<br>Low DS7, DS8              | No                      | 90,000 pounds/<br>120,000 pounds | No –No triples VMT shown  |
| MT    | Very low – mainly rural interstates  | Very low – mainly rural interstates  | Low DS5, DS6, DS8. Med DS7                  | No                      | 131K                             | No – Very low triples VMT, poor reference group and GVW limit doesn't match future configurations.  |
| NE    | No VMT                               | No VMT                               | Low DS5, DS6.<br>Very low DS7.              | No                      | Have to be empty                 | No – Triples have to be empty.  |
| NV    | Med – mainly RI, but also RuralMaj A | Med – Mainly RI, but also RuralMaj A | Med DS5, DS6.<br>Low DS7, DS8.<br>High DS9. | No                      | 129,000 pounds                   | Low priority – Medium triples VMT. Problems with reference group – while DS7 and DS8 are lower than DS5 and DS6, DS9 is higher than DS5 or DS6. Matches 129,000 pounds GVW limit. |
| ND    | Very low                             | Very low                             | Very low DS5, DS6, DS8. Low DS7             | Yes                     | 105,500 pounds                   | Low priority – Very low triples VMT. Remainder of factors good for 105,000 pounds analysis.   |
| OH    | No VMT                               | Very low                             | Very high DS5, DS6. Low DS7, DS8.           | No                      | 115,000 pounds                   | No – Very low triples VMT and GVW doesn't match future configurations.  |
| OK    | Low                                  | Very low                             | High DS5, DS6.<br>Very low DS7, DS8         | Yes                     | 90,000 pounds                    | Low priority – Low triples VMT. Good reference group. GVW doesn't match future configurations.  |

Highway Safety and Truck Crash Comparative Analysis Technical Report

| State | 2008 VMT estimates               |  |                                      | Crash Report Axle Data? | GVW Limit (from FHWA list) | Conclusions   |
|-------|----------------------------------|--|--------------------------------------|-------------------------|----------------------------|---|
|       | TS7                              | TS8+                                     | Reference group                      |                         |                            |   |
| OR    | High RI, High UI. Low RuralMaj A | Low RI, Very Low UI, Very low RuralMaj A | High DS5,DS6,DS7,D S8                | No                      | 105,500 pounds             | Low-Medium priority – Very high triples MVT. But major problems with reference group – can’t separate the DS5/6 from the DS7/8, and all have same VMT. Matches the 105,500 pounds GVW limit.  |
| SD    | Very low                         | Very low                                 | Very low DS5, DS6, DS7, DS8          | No                      | 129,000 pounds             | Low priority – very low triples VMT and reference VMT. Problems with reference group in that doubles cannot be separated by axle count and DS7, DS8 and DS9 have higher VMT than DS5 and DS6. |
| UT    | Med RI, Low UI and RuralMaj A    | Very low                                 | Med DS5, DS6, DS7. Low DS8, High DS9 | No                      | 129,000 pounds             | Low-Medium Priority – Medium triples VMT. Major problems with reference group – can’t separate the DS5/6 from the DS7 or DS9, and all have same VMT.  |

The final choice of States for use in this triples analysis (and indeed the viability of the entire methodology) will depend to a great extent on the adequacy of the WIM data. The WIM stations in any State are somewhat limited. For the analysis to be successful, these “spot counts” must be extrapolated to a large sample of similar roadway sections in the same State. During the Desk Scan phase, no description of such a methodology being used before was identified. An acceptable one will have to be developed.

#### Analysis of Heavy Tractor-Semitrailer Configuration

This second analysis involves comparison of crash experience for two types of tractor-semitrailer configurations. The target future configuration has three axles on the tractor, three on the trailer, and a GVW limit of 97,000 pounds. (These will be referred to as “heavy semitrailers” in the following discussion.) The reference vehicle is the standard tractor-semitrailer combination with the three axles on the tractor, two on the trailer and an 80,000 pounds GVW limit. As in the triples analysis, the primary criteria for including a State in the analysis are:

- There is significant VMT for both the heavy semitrailers and the reference vehicle. (Note that there will be adequate VMT for the reference vehicles in all States.)
- In the crash data, the heavy semitrailers can be distinguished from the reference vehicle using only number of trailers and number of total axles. It is noted that the assumption here is that a six-axle semitrailer is indeed a “heavy” semitrailer. Since VMT for six-axle trucks was found on Interstates in States with a GVW limit of 80,000 pounds, this assumption is not completely true. As noted below, to better identify States in which a six-axle configuration is more likely to be a heavy semitrailer, only States where the six-axle configuration can be identified and which have a GVW limit higher than 80,000 pounds are being considered for this analysis.

The inputs to the decision concerning which States will be used in this analysis were from the following sources:

- A table of “Grandfathered Weights Allowed by States”. This table was prepared by the Truck Size and Weight Program Office within the FHWA Office of Freight Management and Operations. The data are based on U.S. Code Title 23 Section 127.
- A table of “State Weight Exemptions (As of March 2008)”. This table was prepared by the Truck Size and Weight Program Office within FHWA Office of Freight Management and Operations. The data are based on US Code Title 23 Section 127.
- A table of “CTS&WLS Heavies” (grandfathered over 80,000 pounds) allowed on Interstate System. Updated 11-14-13.” This table listing States was developed for use in the *Volume II: Compliance Comparative Assessment* work area of the Study with input provided by CVSA.
- 2008 VMT data for each of 25 vehicle configurations for each of 14 functional classes within each State. The classes of interest in this analysis are target configuration CS6 (conventional tractor-semitrailer with six axles) and reference configuration 3-S2

(conventional tractor-semitrailer with three axles on the tractor and two axles on the semitrailer).

- Presence of “number of trailers” and “number of total axles” variables on State crash report forms. This information was compiled through searches for crash report forms from internet sources.

The results of this combination of data are shown in **Table 2**. The columns are explained in the following text.

Note that the following discussion will concern choosing States for analyses of the heavy semitrailers on Interstates even though information is also desired about the safety of these vehicles on non-Interstate routes. The rationale used is that if a State allows these heavy semitrailers on Interstate routes, they are also very likely to allow them on non-Interstate routes. Then the same State’s data can (and will) be used to analyze safety on both roadway types.

The first two documents were reviewed and compared to identify States that have allowed heavy semitrailers on Interstate highways since at least 2008. Differences between the sources are indicated by a question mark in the GVW Limit column. States with these differences are lower priority than States without. The 13 States allowing use of these heavy semitrailers are listed in the first column of the table. As with the triples analysis, the crash sample size will be maximized by using States with the highest VMT for heavies. The 2008 VMT data for the heavies on rural Interstates, rural major arterials, and urban Interstate/other-expressways were extracted for these 13 States. Finally, information on the presence of crash form variables related to number of axles was added to the table for each heavy semitrailers State. (Note that all of the States have a “number of trailers” variable. Again, the axle count information is critical in the separation of data for the six-axle heavies from the five-axle semitrailers in the reference group.)

Conclusions that were developed concerning the suitability for use in the analysis are shown for each of the heavy semitrailers States in the final column. Recall that the primary three criteria a State should meet in order to allow a sound analysis of heavy semitrailers are:

- High VMT for the heavy semitrailers.
- Ability to separate the six-axle heavy configuration from the five-axle reference configuration in the crash data.
- A GVW limit that matches the 97,000 pounds target limit as closely as possible.

**Table 2. VMT, axle data availability, gross vehicle weight (GVW) limit and conclusions concerning analysis suitability for 13 States allowing six-axle semitrailer-tractor trailers with over 80,000 pounds GVW on Interstates.**

| State | 2008 VMT (000)                           |  |   | No. of axles?   | Interstate GVW Limit                 | Conclusions   |
|-------|--|--|---|-----------------|--------------------------------------|---|
|       | Rural Interstate                         | Rural Maj Art                          | Urban Interstate and Other Expressway   |                 |                                      |   |
| AK    | 2,553                                    | 783                                    | 767                                     | No              | Bridge Form.                         | No – Very low heavies VMT on rural major arterials and urban interstate/expressway. Cannot separate heavies from reference group semitrailers, and no GVW limit.  |
| ID    | 3,977                                    | 2,344                                  | 849                                     | Yes (thru 2010) | 89,500 pounds                        | Medium priority – Medium heavies VMT on rural Interstate and RMA. Can separate heavies from reference group. GVW limit is not 97,000 pounds but close.  |
| KY    | 84,394<br>(6-axle)<br>34,363<br>(7-axle) | 5,046<br>(6-axle)<br>2,054<br>(7-axle) | 29,635<br>(6-axle)<br>1,772<br>(7-axle) | Yes             |                                      | Medium priority – High VMT on Interstate and RMA. Can separate heavies from reference group. May have to use 7-axle to isolate higher weights better. GVW limit is unknown at this time.  |
| ME    | 804                                      | 12,718                                 | 1,751                                   | Yes             | 100,000 pounds (Maine Turnpike only) | Low-medium priority – Low heavies VMT on rural Interstates (Turnpike only). Can separate heavies from reference group. GVW limit is the target limit. (ME could be used for the non-Interstate analyses since detailed AADT data is available through the Highway Safety Information System). |
| MI    | 5,587                                    | 5,793                                  | 12,237                                  | Yes             | 104,000 pounds                       | Medium-high priority – Medium-high heavies VMT on all three classes. Can separate heavies from reference group. GVW limit is not 97,000 pounds but close.   |
| ND    | 1,058                                    | 6,409                                  | 148                                     | Yes             | 105,500 pounds                       | Low priority – Low-medium heavies VMT on rural Interstate and RMA. Can separate heavies from reference group. GVW limit is not 97,000 pounds but is close   |
| NH    | 583                                      | 604                                    | 346                                     | No              | 99,000 pounds or 103,000 pounds      | No – While GVW limit is close to target, very low heavies VMT and cannot separate heavies from reference group vehicles.  |

Highway Safety and Truck Crash Comparative Analysis Technical Report

| State | 2008 VMT (000)    |                   |                                       | No. of axles? | Interstate GVW Limit  | Conclusions  |
|-------|-------------------|-------------------|---------------------------------------|---------------|---|--|
|       | Rural Interstate  | Rural Maj Art     | Urban Interstate and Other Expressway |               |   |  |
| NV    | 355               | 328               | 705                                   | No            | 129,000 pounds  | No – Very low VMT. Cannot separate heavies from reference group semitrailers, and GVW limit is much higher than the 97,000 pounds target.  |
| NY    | 1,670             | 1,498             | 1,439                                 | Yes           | 107,000 pounds  | Low priority – Low-medium heavies VMT on all three classes. Can separate heavies from reference group. GVW limit is not 97,000 pounds but is close   |
| OH    | 16,821            | 1,862             | 10,180                                | No            | 120,000 pounds  | No – Even though high VMT, cannot separate heavies from reference group vehicles and GVW limit is much higher than the target GVW.   |
| OR    | -                 | -                 | -                                     | No            | 100,000 pounds  | No – No data on VMT due to data issues in earlier study and cannot separate heavies from reference group.  |
| UT    | 4,718             | 1,387             | 1,401                                 | No            | 94,000 pounds   | No – While medium heavies VMT and a GVW limit close to the target limit, cannot separate heavies from reference group vehicles.  |
| VT    | 286               | 243               | 83                                    | Yes           | 100,000 pounds for forest, milk, quarry haulers; 90,000 pounds for others | No – While GVW limit is close to target (for some trucks) and the heavies can be separated from the reference group, the heavies VMT is extremely low.   |
| WA    | 4,230<br>(7 axle) | 5,725<br>(7 axle) | 15,977<br>(7 axle)                    | Yes           | 105,500 pounds  | Medium priority – Medium heavies VMT but would have to use 7-axle configuration. Can separate heavies from reference group. GVW limit is not 97,000 pounds but is close. In addition, detailed AADT and roadway data are available through HSIS. |
| WY    | 1,639             | 2,049             | 58                                    | Yes           | 117,000 pounds  | Low priority – Low-medium heavies VMT. Can separate heavies from reference group. VGW limit is not as close to target limit as in other States.  |

While none of the States allowing heavies fit all three criteria, at this point it appears that the best States are as follows:

- Michigan – Medium-high VMT for heavy semitrailers on all three road classes, and the presence of the axle count variable on the crash form means that heavy semitrailers can be separated from the reference group. While the 104,000 pounds GVW limit is not 97,000 pounds, it is close.
- Idaho – Less acceptable than Michigan – Medium heavies VMT on rural Interstate and rural major arterials. The heavies can be separated from the reference group semitrailers. While the GVW limit of 105,500 pounds is not the target 97,000 pounds, it is close.
- Washington – Medium VMT for heavy semitrailers, but may have to use the 7-axle configuration rather than the target 6-axle configuration to better identify heavier GVWs. The presence of the axle count variable on the crash form means that heavy semitrailers can be separated from the reference group. While the 105,500 pounds GVW limit is not 97,000 pounds, it is close. In addition, crash data and detailed AADT and roadway data which will be needed in the analysis are available through FHWA's Highway Safety Information System (HSIS).
- Kentucky – Very high VMT for heavy semitrailers on Interstate and RMA. The presence of the axle count variable on the crash form means that heavy semitrailers can be separated from the reference group. May have to use 7-axle configuration to better isolate heavier GVWs. Unfortunately, the GVW limit is unknown at this time.
- Maine – Less acceptable than the other four due to low VMT for heavy semitrailers on rural Interstates. This is because heavies have traditionally been limited to the Maine Turnpike. However, Maine crash, AADT and other roadway data are available through HSIS. If examination of heavy semitrailers crashes on the Turnpike indicates a sufficient sample size, the priority will increase. The heavy semitrailers can be separated from the reference group semitrailers, and the GVW limit is equal to the target 97,000 pounds.

As with the triples analyses, the final choice of States for use in this heavy semitrailers analysis will depend to a great extent on the adequacy of the WIM data. There must be acceptable numbers of WIM stations within each State and an acceptable methodology will have to be developed to extrapolate the limited WIM station counts to a large sample of similar roadway sections in the same State.

It is important to note that roadway safety infrastructure like median barriers and guide rail systems must be considered as part of the evaluation of heavy commercial motor vehicle impacts. Currently, median barriers are tested using a 80,000 pound truck's impact. A weight increase causes a re-examination as to the durability and performance of median barriers as well as guide rail. Guidance and direction from FHWA's Office of Safety in performing an assessment on roadway safety infrastructure performance is being formulated so as to assess the impacts that heavier trucks may have in this area.



### Data Availability for Method 3 Analyses

As noted above, crash data, roadway inventory data and AADT data for 2008-2012 will have to be acquired for both the triples and heavies study for each State chosen. At this point there are eight candidate States – Oregon, Kansas, Nevada and Utah for the triples study, Washington, North Dakota and perhaps Maine for the heavy semitrailers study, and Idaho for both.

Washington and Maine crash, inventory and AADT data are available from HSIS. NHTSA's State Data System (SDS) has captured multiple years of crash data from certain States. Some States will allow non-NHTSA access to their data with prior permission. If SDS crash data are not available, a request for the data will be made to the State. Current SDS information indicates the following:

- Triples study
  - Idaho – No SDS data. Will have to obtain from Idaho.
  - Oregon – No SDS data. Will have to obtain from Oregon.
  - Kansas – 2008 data available with permission in SDS. 2009 -2012 data will have to be obtained from Kansas.
  - Nevada – No SDS data. Will have to obtain from Nevada.
  - Utah – No SDS data. Will have to obtain from Utah.
- Heavies study
  - Michigan – 2008-2009 data available with permission in SDS. 2010-2012 data will have to be obtained from Michigan.
  - Idaho – No SDS data. Will have to obtain from Idaho.
  - Washington – Available in HSIS.
  - Kentucky – 2008-2010 data available with permission in SDS. 2011 -2012 data will have to be obtained from Kentucky.
  - Maine – Available in HSIS.

In general, SDS will not be a useful source of crash data for this study. All years of crash data for the chosen States will have to be collected from the States.

Except for Washington and Maine, roadway inventory and AADT data will have to be obtained directly from the chosen States. It is noted that States generally only retain current year inventory data, but usually do retain historical AADT data.

Except for Washington and Maine where customized analysis files can be obtained from HSIS, the development of State analysis files will require significant effort. Crashes involving the trucks to be analyzed will have to be linked with roadway segments in order to link with AADT data. WIM station data (perhaps with a different linear reference system than the crash and inventory/AADT data) will have to be linked to the roadway segments and extrapolated to longer study segments. Procedures will be formulated to link and merge State-based crash, inventory and AADT data to make this complex process as efficient as possible.

### Limitations of State Crash Rate Analyses

- A key assumption in the heavy semitrailer analysis is that a six-axle tractor-semitrailer combination is a “heavy” vehicle type in all cases. Since six-axle VMT was found on Interstates in States with a GVW limit of 80,000 pounds, this may not be completely true. State permit information is needed to determine if indeed these vehicles are operating at 80,000 pounds or less or operating under a State issued overweight permit at a weight greater than 80,000 pounds. In other cases, 6-axle trucks may be operating at or below current Federal weight limits. Further investigations will be conducted in this area.
- The current six-axle configurations may be carrying different commodities than will the CTS&WLS alternative six-axle configurations. Thus, the carriers may differ, which in turn may cause the “safety culture” to differ (*e.g.*, driver training, driver experience, truck maintenance procedures, equipment age, etc.) The study will identify any commodity specific qualifications for current six-axle data used from the States from which it is gathered.
- The drivers of the current six-axle configurations may differ from the future drivers in terms of training, experience, and abilities.

Unfortunately, none of these factors can be controlled for in data available for use in this Study. However, even if such data existed (*e.g.*, crash data concerning the driver’s years of experience driving triples), it is not possible at this time to accurately predict what the future fleet will be. While certainly not perfect, the goal of this crash analysis is to provide as much data-driven information as possible for use in decisions concerning that future fleet.

### **B.4 Analysis of Vehicle Stability and Control**

In brief, the work in this subtask is to develop computer models of a various vehicle configurations, simulate those configurations through a series of scenarios, and observe trends in objective performance parameters.

Consultation with personnel from USDOT’s FHWA, National Highway Traffic Safety Administration (NHTSA) and Federal Motor Carrier Safety Administration (FMCSA) will be conducted to investigate the differences in vehicle performance with regard to vehicle stability and vehicle control (VSC) for trucks that operate within Federal size and weight limits and actual or hypothetical trucks that might operate in excess of current Federal limits. An evaluation and assessment of the operational performance will be conducted with regard to stability and control, including vehicle braking, for the alternative configurations selected for this project. These alternative truck configurations will be evaluated with regard to their performance maneuvers or scenarios. The performance of the vehicles will be compared with two control vehicles that meet current Federal truck size and weight limits: a 5-axle tractor with a 53 ft semitrailer having a GVW of 80,000 pounds, and a tractor with twin 28 ft semitrailers, also with five axles and weighing 80,000 pounds.

**Figure 3** depicts the approach graphically. The alternative configurations to be assessed in the Study have been identified and the highway network scenarios are currently being developed. This broad guidance will be translated into specific vehicle models and maneuver paths. Finally, an examination of the results will be undertaken to identify trends and commonalities and assemble a set of technical findings.

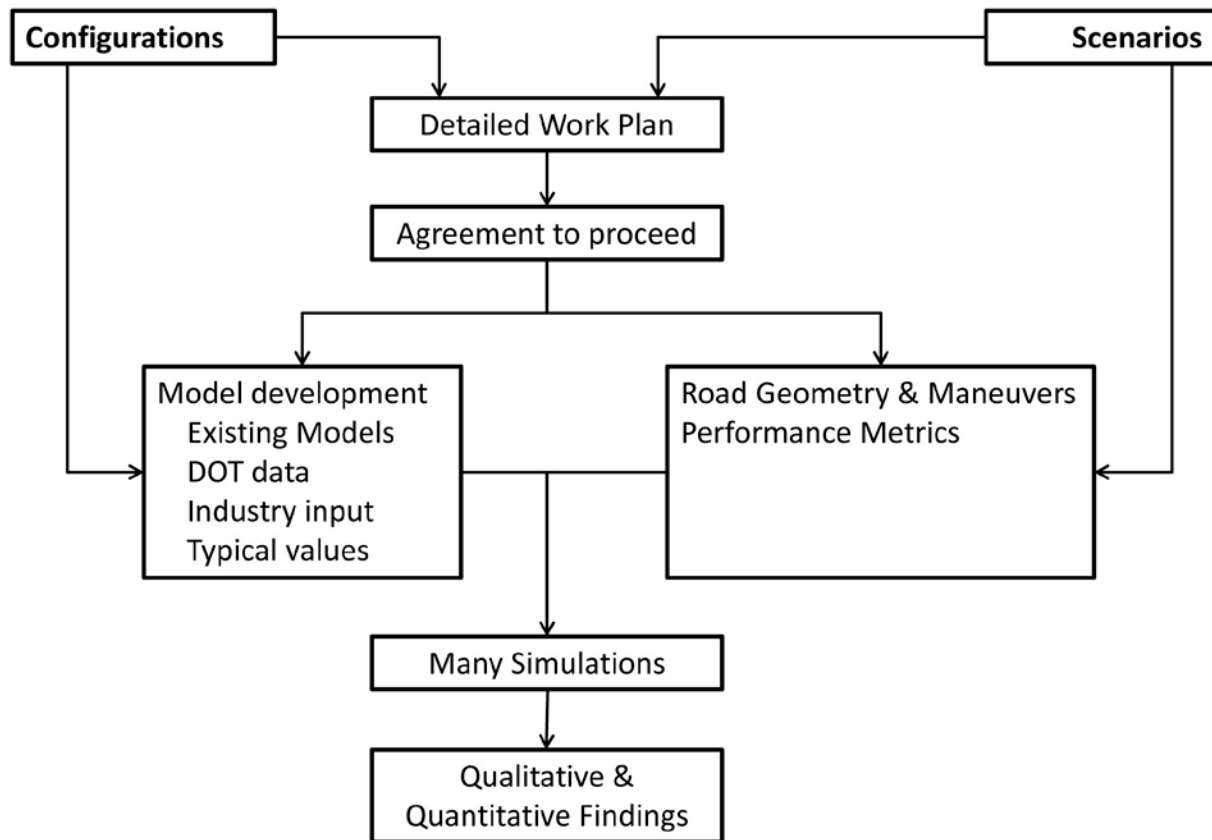
### **Data**

Data to support this effort will come from a number of sources. Consultation with personnel that have validated models of heavy vehicles in many configurations that approximate those being considered will be conducted. Inputs will also come from industry or inquiries program area experts within FHWA. Publications will be consulted as necessary, and other activities within this project are expected to produce relevant findings as well.

### **Model**

Models of proposed configurations of large vehicles will be developed in TruckSim, a commercially available and widely accepted software package. The configurations will be run through a series of scenarios.

**Figure 3. Vehicle Stability and Control Approach Workflow**



### Configurations

Six commercial motor vehicle configurations have been selected for the Study, as presented in **Figure 4**. One vehicle in each geometry will be modeled, and then the variations in loading and braking condition discussed below will be made. All are dry van trailers with rigid loads. Steer axles will have two tires, and all other axles will have duals on both ends. As indicated in the figure, most of the multi-trailer geometries will be modeled with two styles of couplings, “A-train” and “B-train.” All vehicles will be modeled with air ride suspension rather than leaf springs. Vehicle tare weights, dimensions, suspension behavior, and other properties will be typical of United States practice.

Within most of the geometries, at least two load distributions are planned. All loads will be fixed and will be centered longitudinally and laterally within the trailer. Inertias and vertical load locations will be representative of prior testing.

**Figure 4. Commercial Motor Vehicle Configurations Included in the Study**

| Configuration                                  | # Trailers or Semi-Trailers | # Axles | Gross Vehicle Weight (pounds) |
|--|-----------------------------|---------|-------------------------------|
| 1. 5-axle vehicle                              | 1                           | 5       | 80,000 [baseline]             |
|  | 1                           | 5       | 88,000                        |
| 2. 6-axle vehicle                              | 1                           | 6       | 91,000                        |
|  | 1                           | 6       | 97,000                        |
| 3. Tractor plus two 28 or 28 ½ foot trailers   | 2                           | 6       | 80,000 [baseline]             |
| 4. Tractor plus twin 33 foot trailers          | 2                           | 6       | 80,000                        |
| 5. Tractor plus three 28 or 28 ½ foot trailers | 3                           | 7       | 105,500                       |
| 6. Tractor plus three 28 or 28 ½ foot trailers | 3                           | 9 or 10 | 129,000                       |

In the two braking scenarios listed below, each of the above combinations will be tested in three braking conditions:

- Functioning Anti-lock braking system (ABS) on all axle ends. Normal TruckSim ABS model.
- ABS malfunctioning on one axle end. The wheels lock when brakes are applied.
- Brake malfunctioning on one axle end. Braking torque is zero.
- FMCSA brake testing data on 3S-2 Base Case 80K, and 88K will be reviewed and included in the study.
- FMCSA brake testing data on 3S-3 97K pound truck will be reviewed and included in the study.

Vehicle Stability and Control Scenarios

The vehicle configurations will be simulated in various VSC scenarios to evaluate their performance. To the extent possible, scenarios will be based on established test procedures so that the results will be comparable with those of other studies.

These maneuvers and associated metrics are based on prior studies of larger trucks. The crash data and fleet analyses may find other specific vulnerabilities of certain configurations of trucks.

**Figure 4** includes the listing of truck configurations being evaluated in the Study.

### Methodology

The steps are:

- Determine the vehicle dimensions, axle spacing, fifth wheel settings and hitch offsets that represent practical vehicle design characteristics. Determine other vehicle properties such as the cargo load characteristics and generalized tire and suspension properties. Consultation with industry will be required at this step.
- Assemble simulations models and compile each configuration.
- Define roadway models and simulated maneuvers to represent each of the VSC scenarios.
- Finalize the performance metrics. Some of the standards in **Table 3** are based on those in the 2000 Comprehensive Truck Size & Weight Study as well as the 2004 Western Governor’s Uniformity Scenario Analysis.
- Run the simulation models.
- Conduct the comparative analysis and codify the findings.

Certain quantities will be extracted from the results of each simulation to calculate performance-metrics, such as load transfer ratio, maximum lateral excursion, and rearward amplification. These metrics will be tabulated according to vehicle configuration so that the behavior of the respective configurations can be compared.

Trends and commonalities in the metrics will be noted and put in the draft report that documents the assumptions, approach, and results. The report will justify the assumptions. Example images to illustrate the scenarios will be included. Details of the models and raw data are expected to be in appendixes.

**Table 3. VSC Scenarios through which alternative truck configurations will be simulated**

| Name                      | Description                      | Comments  | Performance-based metrics        |
|---------------------------|----------------------------------|---|----------------------------------|
| 1. Low-speed offtracking  | 41 ft-radius curve at 3.1 mph    | as in Figure VI-1 of the WUSR                                 | Offtracking                      |
| 2. High-speed offtracking | 1289 ft-radius curve at 62 mph   | as in Figure VI-2 of the WUSR                                 | Offtracking, Load transfer ratio |
| 3. Straight-line braking  | procedure of the 60-mph stopping | load as specified in Figure 4 and Brakes on all axles, except | Stopping Distance,               |

| Name                  | Description  | Comments   | Performance-based metrics   |
|-----------------------|--|--|---|
|                       | distance test in S5.3.1.1 of FMVSS 121   | simulated malfunctions   | Maximum lane excursion  |
| 4. Brake in a curve   | Procedure of the brake-in-a-curve test in S5.3.6.1 of FMVSS 121. 30 mph.         | Load as specified in Figure 4 and brakes on all axles, except simulated malfunctions   | Stopping distance, Maximum lane excursion, Load transfer ratio      |
| 5. Avoidance maneuver | Single lane change similar to ISO 14791, Lateral stability test methods. 50 mph. | Transient off-tracking and rearward amplification are defined by ISO 14791 using a steering pulse that produces a path similar to a single lane change. Because the steering mechanism is not a focus of this study, Battelle may choose instead to model a single lane change defined by road geometry. | Transient off-tracking, Rearward amplification, Load transfer ratio |

### Approach

The technical approach will be conducted by performing the following tasks.

#### Build Simulation Models

The models will be built in TruckSim. Models for some of the configurations are expected to be available from prior projects. Models for other configurations can be adapted from these models. The models will be developed primarily using vehicle and tire parametric data currently available in the public domain. As necessary, vehicle and tire data sets will be augmented to fit specific vehicle configurations and loading conditions. This project does not include making any laboratory measurements to obtain vehicle or tire parameters, or conducting dynamic field tests for the purpose of validating full vehicle models. Models will be built so they represent vehicles that meet the current stopping distance requirements of Federal Motor Vehicle Safety Standards (FMVSS) 121. Electronic Stability Control, as in the proposed new FMVSS 136, is not included. The selected configurations to be modeled are presented in **Figure 4** and serve as the basis for estimating the effort.

Roadway models will be developed to define the scenarios in **Table 3**. Simulated vehicle runs will be made to follow the desired path using open-loop control or the driver model in TruckSim, whichever achieves the best approximation in each scenario.

A means of efficiently will be developed executing the many simulations. This will allow key values to be extracted from the simulation results, so the performance-based metrics can be calculated from them.

Execute the Simulations

The six basic geometric truck configurations and their variants will be run through the VSC scenarios according to the project plan. As simulations are run, a check for unexpected results will be made and adjustments to the models may be needed or new cases may need to be run to answer questions that arise. A number of preliminary simulation runs will be necessary to develop the models. Some runs may be repeated under slightly varying conditions to isolate the worst case behavior. The number of simulation runs in the final set to calculate the performance metrics is estimated in the **Table 4**. The first row of numbers is for the VSC scenarios that do not require braking, and the second row of numbers is for the straight and curved braking scenarios.

Summarize Findings

Findings on the simulation results and their implications will be prepared for the stability and control of vehicles within and beyond current Federal truck size and weight limits. The trends and commonalities discovered in the simulations results will be provided. Tables and sketches will document the configurations and variations. Animation stills and graphs will depict the scenarios. Detailed descriptions of the models will also be provided.

**Table 4. Number of Required Simulation Runs.**

| Number of geometries and load distributions (Figure 2) |   | Number of braking conditions |   | Number of Scenarios (Table 1) |   | Subtotal number of simulation runs |
|--|---|------------------------------|---|-------------------------------|---|------------------------------------|
| 15   | X | 1                            | X | 3                             | X | 45                                 |

| Number of geometries and load distributions (Figure 2) |   | Number of braking conditions |   | Number of Scenarios (Table 1) |   | Subtotal number of simulation runs |
|--|---|------------------------------|---|-------------------------------|---|------------------------------------|
| 15   | X | 3                            | X | 2                             | X | 75                                 |

**B.5 Safety Inspections and Violations Analysis**

The goal of this subtask is to understand the implications of truck size and/or weight on the safe highway operations, on the rate of consumption of service life of roadway infrastructure (pavement and bridge service life) and on goods movements by other modes of transportation.



## **Approach**

### Identify Data Needs

The use of current, accurate data and up-to-date, effective modeling tools is critical to the success of this project. The USDOT is in possession of a number of national datasets related to commercial vehicle operations. For example, data from Commercial Driver's License Information System (CDLIS) can provide information on the type of licenses that exist among commercial drivers (number of Class A, B, and C, with special restrictions/exemptions to exceed Federal weight limits). Multi-year data from the Motor Carrier Management Information Systems (MCMIS) will be relevant for identifying crashes and inspection violations that may be associated with weight and size limits. The inspection file contains a field for GVW, which will be particularly useful for segmenting truck configurations (Subtask 2). This database also contains company safety profiles.

As part of this task, an additional search through the literature may be needed to identify factors associated with truck weight and size violations. Based on these past studies and discussions with experts in the field, a list of the variables needed to conduct the safety inspection and violations analysis will be prepared and national databases identified where data would be obtained the data.

### Finalize Technical Analysis Plan

The data identified in the prior task will be reviewed and efforts will be made to fill in gaps where there are missing data or if additional variables are needed. Once the data is prepared, work will begin on data segmentation/aggregating the data as appropriate for data analysis. The specific data segmentations will include (but not limited to):

- a) Classifying specific configurations for comparisons (*e.g.*, tractor-semitrailers) as 80,000 pounds or over 80,000 pounds using the GVW field in the inspection data.
- b) Aggregating inspections from States to sets with relatively similar size and weight regulations.
- c) Primarily, Level 1 Inspections will be analyzed. Level 2 and Level 3 Inspections will also be included where driver training requirements are relevant (for example, operating combinations that include double and triple-trailer combinations).
- d) Segmenting violation types based on driver, vehicle, or other (*e.g.*, paperwork).

### Data Analysis

In this task, an assessment of the impact that a truck's compliance with size and weight limits on safety will be conducted using the data procured and cleaned from work completed earlier in this area of the Study. The data analysis will include descriptive statistics, which will include

numerical (*e.g.*, mean, standard deviations, min, max) and graphical summaries (*e.g.*, boxplots, time-series plots and trends). The descriptive statistics will reveal if there are any patterns of violations for within 80,000 pounds and over 80,000 pounds configurations. The descriptive statistics will also show whether patterns of violations exist for States that follow the Federal 80,000 pounds weight limit and those that permit operations over 80,000 pounds. These patterns will be further examined using inferential statistics as appropriate.

The inferential statistics will be highly dependent on the quality of data received and will be regression based given the a priori hypothesis. The data is also multi-year and will most likely require a mixed linear model, random effects approach. A crucial component will relate to the sample size for specific events associated with weight and size limits. If the sample size is small, a reevaluation will be conducted as to whether rolling up the data to the carrier level would be more meaningful, or if a bootstrapping method (to resample based on the distribution of the existing sample) would be feasible. Incidence and rate of violations and out-of-service conditions for within 80,000 pounds and over 80,000 pounds configurations will be computed. Rates will be computed for weight-related, specific systems critical to safe operations for alternative truck configurations, drivers, and other violations as available from the data.

### Summarize Findings

A summary of the findings of the data analyses will be completed for the safety inspections and violations analysis and provide input to the final report.

### **B.6 Findings Summary and Final Report**

The results of all analysis efforts – truck crash, vehicle stability and control, and safety inspections, and violations – will be compiled into a findings summary and final report.

**B.7 Proposed Schedule for Completion**

Project work described in this plan will be completed according to the following schedule:

| Task/Deliverable  | Completion/Deliverable Date   |
|---|---|
| <i>Subtask 1.2 – Desk Scan</i><br>Draft Desk Scan<br>Final Desk Scan  | September, 2013<br>November, 2013   |
| <i>Subtask 1.3 – Analysis of Crash Data</i><br>Acquisition of State Crash Data<br>Acquisition of Fleet Crash Data<br>Acquisition of Exposure Data<br>Analysis of State Crash Data<br>Analysis of Fleet Crash Data<br>Draft Findings | December, 2013<br>December, 2013<br>December, 2013<br>March, 2014<br>March, 2014<br>April, 2014 |
| <i>Subtask 1.4 – Analysis of Vehicle Stability and Control</i><br>Build Simulation Models<br>Execute the Simulations<br>Draft Findings  | February, 2014<br>March, 2014<br>April, 2014  |
| <i>Subtask 1.5 – Safety Inspections and Violations Analysis</i><br>Identification of Data Needs<br>Data Acquisition<br>Data Analysis<br>Draft Findings  | December, 2013<br>January, 2014<br>March, 2014<br>April, 2014                                   |
| <i>Subtask 1.6 – Findings Summary and Final Report</i><br>Draft Findings<br>Draft Report<br>Final Report  | April, 2014<br>April, 2014<br>May, 2014   |

## References

Abdel-Rahim, A., S. G. Berrio-Gonzales, *et al.* (2006a). Classification of Longer Combination Vehicles Using Weigh-in-Motion Data. Final Report Part A. University of Idaho. , National Institute for Advanced Transportation Technology.

Abdel-Rahim, A., S. G. Berrio-Gonzales, *et al.* (2006b). Longer Combinations Vehicles: A Comparative Crash Rate Analysis. Final Report Part B. University of Idaho. , National Institute for Advanced Transportation Technology.


AASHTO (2010). Highway Safety Manual, AASHTO, Washington, D.C.

Bonneson, J.A. and M.P. Pratt (2008), Procedure for Developing Accident Modification Factors from Cross-Sectional Data. *Transportation Research Record: Journal of the Transportation Research Board*, No. 2083, Transportation Research Board of the National Academies, Washington, DC.

Hauer, E., "On exposure and accident rate," *Traffic engineering and control*", 36(3) (1995): 134-138

Jovanis, P.P., H. Chang and I. Zabaneh. "Comparison of Accident Rates for Two Truck Configurations," *Transportation Research Record*, 1249, Washington, D.C., pp. 18-29, 1990.

*Project Plan Appendix*

|   |  |
|---|--|
|  | <p><b>Data Use Agreement</b><br/> <b>Comprehensive Truck Size and Weight Limits Study</b></p>  |
| <p><b>Data Use Agreement Parties and Purpose</b></p>                              | <p>This Data Use Agreement (“Agreement”) is between the University of North Carolina, a North Carolina governmental entity, on behalf of its Highway Safety Research Center, with an address at 730 ML King Jr Blvd, Chapel Hill, NC, 27516 (“UNC”), and <u>COMPANY NAME</u>, a <u>[Insert State of Incorporation]</u> with an address of <u>[Insert Address]</u>(“Carrier”). The purpose of this agreement is to address the uses and security of the data acquired from the Carrier for the <i>Comprehensive Truck Size and Weights Limits Study</i>. UNC is a subcontractor to CDM Smith, whose prime contract (No. DTFH61-11-D-00017) (the “Study”) is with the U.S. Department of Transportation Federal Highway Administration (the “Sponsor”).</p>  |
| <p><b>Data Description</b></p>  | <p>The data requested from the Carrier that will be subject to the conditions, use restrictions and protections under this Agreement (“Data”), are included in <u>Attachment A</u>, which contains the detailed list of data elements (and their attributes) that the Carrier is being asked to provide to UNC for the research study.</p>   |
| <p><b>Uses and Restrictions</b></p>   | <p>The data acquired from the Carrier is subject to the following uses or restrictions:</p> <ol style="list-style-type: none"> <li>1) Access to the complete Data submission will only be granted to UNC staff working on the Study with a need to have such access and a duty to preserve its confidentiality. Limited data summary tables, extract files, and analysis results produced from the database will be provided to members of the project safety analysis team, including consultants working for CDM Smith and will be stripped of information that could reveal the Carrier’s identity (see “Protection of Data” below).</li> <li>2) The Data will only be used for the analysis conducted to meet the objectives of the Study and will be destroyed twelve (12) months after the Study’s submission to the Sponsor.</li> <li>3) Results from the analysis of the Data will be reported as anonymous with respect to the Carrier. Most analyses will be reported by aggregating results from several carriers, further shielding the identity of individual carriers.</li> <li>4) The data will not be used in a manner that is inconsistent with or would violate any applicable State or Federal law, including but not limited to the Federal Privacy Rule.</li> </ol> |

|                             |   |
|-----------------------------|---|
| <b>Protecting Data</b>      | The data from each Carrier will be assigned identifiers (the “Key”) allowing the data to be analyzed at the Carrier, State, region, and other levels as needed for analysis. Analysis results will not be released at any summary level that would allow the Carrier to be identified. The variables used to generate the Key will be removed from the data used by the team for analyses. The Key for each Carrier will not be shared with CDM Smith, the Sponsor, or the public under any public records law or freedom of information type law or regulation. The Key will be destroyed along with Data twelve (12) months after submission of Study to the Sponsor. |
| <b>Storing Data</b>         | The users of the database received from the Carrier will abide by all UNC policies pertaining to security of electronic data. The computer system(s) holding the data will be kept in full compliance with UNC policies. The system(s) used to store this data are subject to audit for compliance by UNC Information Security staff at any time.   |
| <b>Disclosure</b>           | The full extent of the database received from the Carrier will not be disclosed to external parties, including the prime contractor (CDMSmith) and the research sponsor (USDOT FHWA).   |
| <b>Reporting</b>            | Any unauthorized use or disclosure of the database received from the Carrier will immediately be reported to the UNC Chapel Hill Privacy Officer and the Carrier.   |
| <b>Term and Termination</b> | The term of this Agreement shall be effective as of the date written below and shall terminate 1 year after the end of the subcontract agreement between UNC and CDMSmith. All data received from the Carrier will be disposed of at that time in accordance with UNC policies. The termination date may be extended if both parties agree to an extension of this agreement.   |

Project Name: *Comprehensive Truck Size and Weight Limits Study*

\_\_\_\_\_  
 Authorized Agent  
 UNC HSRC

\_\_\_\_\_  
 Authorized Agent  
 Carrier

\_\_\_\_\_  
 Date

\_\_\_\_\_  
 Date

## APPENDIX C. MANEUVERS FOR THE VEHICLE STABILITY AND CONTROL ANALYSIS

This appendix documents the five maneuvers that were simulated in TruckSim<sup>®</sup> to evaluate the performance of the control and study vehicles. Each maneuver is described by a path and a speed. The avoidance maneuver required a family of similar paths. Each run of TruckSim<sup>®</sup> produced an output data file. These files were analyzed with Matlab<sup>®</sup> to calculate the desired performance parameters. **Table 24** of the main report lists the performance metrics that were extracted from each of the five maneuvers and the peril that each is intended to assess.

### **Maneuver 1. Low-Speed Off-tracking**

When a long vehicle makes a sharp turn at an urban intersection or at a right-angle intersection of two highways, the rear axles follow a path well to the inside of the steer axle path. Any instance of a trailing axle not exactly following the steer axle path is called off-tracking, and low-speed off-tracking can affect, for example, the placement of stop signs on reasonable access routes or the design of curbs on freeway entrance and exit ramps.

#### ***Path Description***

The path to assess low-speed off-tracking, illustrated in **Figure C1**, was the same as was used in prior work (USDOT 2000). The maneuver began with a straight path for 60 ft., long enough to establish stable motion. A curve to the right with a radius of 41 ft. began suddenly without an entry spiral. The path continued in the curve for 64.4 ft., which was a bend of 90 degrees. The path returned to a tangent, again without a spiral. The path continued for 105 ft., long enough for all vehicles to resume straight stable motion. The pavement was flat and dry with a coefficient of friction of 0.9.

#### ***Speed***

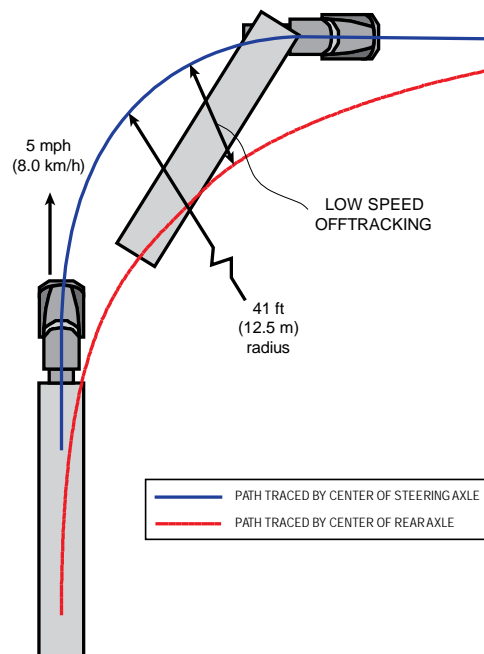
This maneuver was conducted at a constant speed of 5 mph.

#### ***Analysis***

The data extracted from the output file was the paths of the centerlines of each axle. TruckSim<sup>®</sup> reports the data as X-Y pairs of locations at each time step. These Cartesian coordinates were converted to polar coordinates where the origin was the center of the curve.

The analysis began at the moment the steer axle entered the curve, and it ended when the final axle passed the end of the curve.

**Figure C-1. The Low-speed Off-tracking Maneuver.**



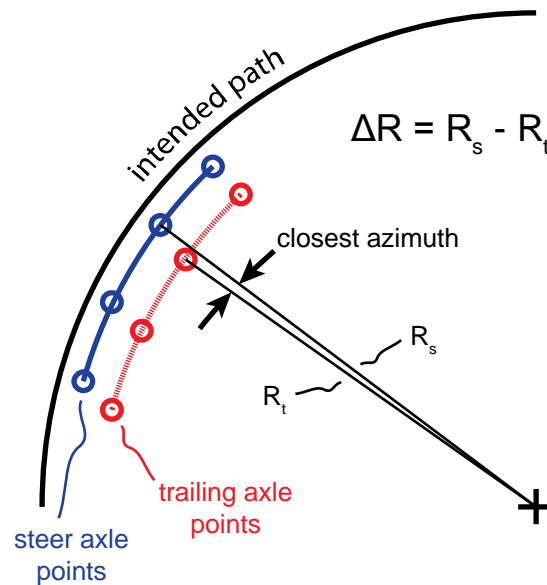
The analysis followed the path of the steer axle, which was the baseline from which deviations were measured. The analysis is illustrated in **Figure C2**. In outline form, the analysis steps were:

- For each point on the steer axle path, find the off-tracking of all the trailing axles.
- For each trailing axle, find the point whose azimuth is closest to the azimuth of the steer axle position. Compute the difference in radii of the trailing axle and the steer axle.
- The result is an array with one column for each trailing axle and one row for each azimuth considered. The highest value in the array is the worst off-tracking of the truck in this scenario.

If the steer axle perfectly followed the desired path, then the off-tracking of the subsequent axles would be the same as their displacement from the path. The steering model was not perfect, so the off-tracking values of drive and trailer axles were not identical to their absolute displacement values. The off-tracking was reported for the low- and high-speed off-tracking maneuvers and the transient maneuver because they are intended to measure off-tracking. The absolute displacement was reported for the two braking maneuvers because FMVSS No. 121 imposes a lane position requirement.



**Figure C2. The Low-speed Off-tracking Calculation Points.**



### **Maneuver 2. High-Speed Off-tracking**

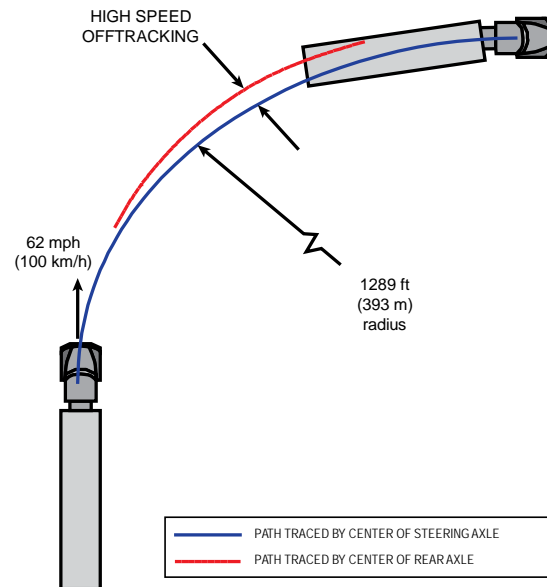
When a vehicle is on a curve on a highway, its trailing axles may follow a path identical to that of the steer axle. Or, depending on the speed, the placement of the load, the tire properties, and other factors, the trailing axles may track inside or outside of the steer axle.

The maneuver to assess the high-speed off-tracking characteristics of the vehicles was also drawn from prior work (USDOT 2000).

#### ***Path Description***

The path began with a straight segment for 2000 ft., long enough to establish stable motion. A curve to the right with a radius of 1,289 ft., as illustrated in **Figure C3**, began suddenly without an entry spiral. The path continued in the curve for 4,049.5 ft., which was a bend of 180 degrees. The pavement was flat and dry with a coefficient of friction of 0.9.

**Figure C3. The Simulated High-speed Off-tracking Maneuver.**



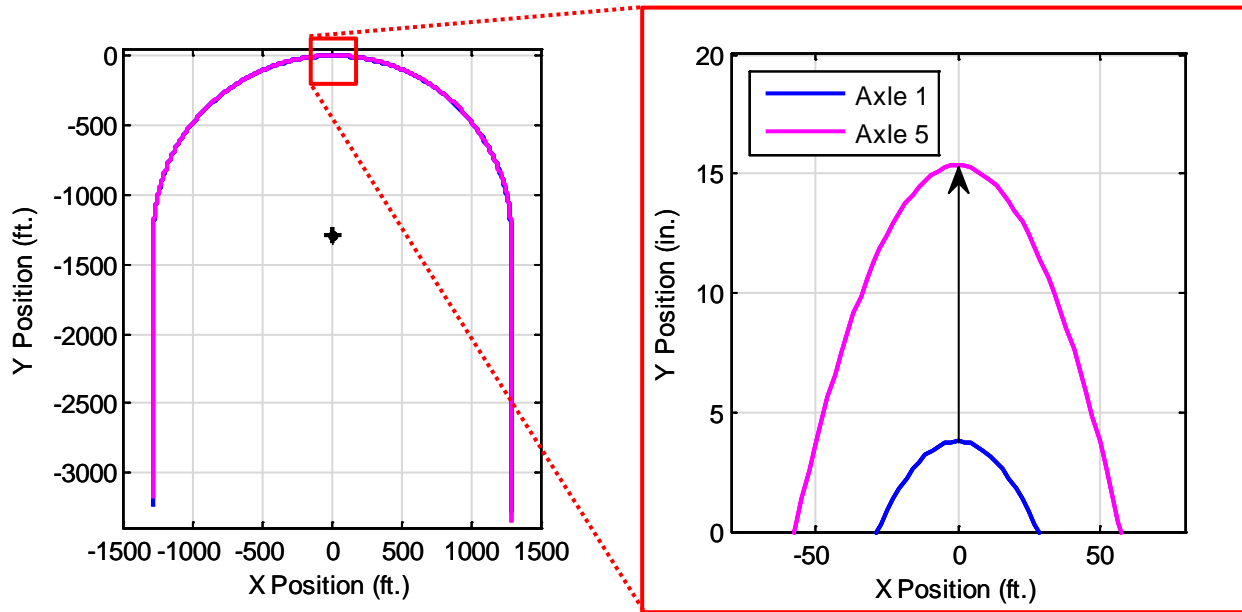
### *Speed*

This maneuver was conducted at a constant speed of 62 mph.

### *Analysis*

The data extracted from the output file were the paths of the centerlines of each axle. The data were Cartesian X-Y pairs of locations at each time step. The desired output was the steady-state off-tracking value. Steady state was reached after a few truck lengths. As each axle passed the 90-degree azimuth where the X coordinate was zero, its Y coordinate was noted as illustrated in **Figure C4**. The position of the steer axle was the reference. The differences of successive axle centers from the steer axle position were calculated. For all vehicle configurations, the rearmost axle demonstrated the worst off-tracking. This off-tracking value was reported in **Table 26** of the main text.

**Figure C4. High-speed Off-tracking Path Differences**



### **Maneuver 3. Straight-Line Braking**

FMVSS No. 121 provides a straight-line braking test in S5.3.1.1. The conditions of the test were simulated for this maneuver, but with two exceptions. First, the straight-line braking test in S5.3.1.1 applies to a tractor with an unbraked control trailer, but the simulated vehicles were loaded according to **Figure 4** of the main text, as they were for all maneuvers. In the first case for this maneuver, all axles were braked. The second exception is that two more cases were run with simulated malfunctions intended to destabilize the vehicle. One was a partial brake failure, where no braking torque was produced on the affected axle ends, and the other was an Antilock Braking System (ABS) malfunction, where tires on the affected axle ends could lock. Both failures were applied on an axle group on one side of the vehicle, to create a yaw moment. The failures were on the right side of both drive axles on the single-trailer combinations. They were on one end of the lead dolly in the multi-trailer combinations.

#### ***Path Description***

This scenario used a straight path. Quoting from FMVSS No. 121, “S5.3.1.1 Stop the vehicle from 60 mph on a surface with a peak friction coefficient of 0.9 . . .”

#### ***Speed***

The vehicle began at 60 mph. After the vehicle established stable motion, the service brakes were applied at 120 psi.

### *Analysis*

These runs were analyzed two ways.

#### Stopping Distance

S5.3.1 of FMVSS No. 121 specifies that the beginning of the stopping distance is the “point at which movement of the service brake control begins.” This was known from the TruckSim<sup>®</sup> brake control output variable, which yielded a Boolean value of 1 when brakes were applied and a Boolean value of 0 when brakes were not applied. The end of the stopping distance was the point where the speed reached 0, which was determined from the output.

#### Maximum Path Deviation

The lateral distance from the lane center to the center point of each axle was measured, and the peak absolute value was extracted for each vehicle simulation.

### **Maneuver 4. Brake in a Curve**

This scenario challenged the stability of the vehicles in hard braking on a curved, wet roadway. It was based on S5.3.6 of FMVSS No. 121, which is a stopping test on a curved roadway with a peak friction coefficient of 0.5. The effect of this provision of the air brake standard is to require ABS. As with the straight-line braking scenario, this scenario was run with normally functioning brakes on all axle ends and with brake failures and ABS malfunctions in the positions most likely to produce instability.

#### *Path Description*

The maneuver was conducted on a continuous curve with a radius of 500 ft.

#### *Speed*

The vehicle began at 30 mph. After the vehicle established stable motion, a full-treadle (120 psi) brake application began.

### *Analysis*

These runs were analyzed three ways.

#### Stopping distance

Although it is not a requirement of this test in FMVSS No. 121, the stopping distance for every vehicle was measured as it was in the straight-line braking test.

#### Maximum Path Deviation

This was calculated and reported as in the straight-line braking test. The Cartesian coordinates were converted to polar coordinates where the origin was the center of the curve. The path

deviation of each axle was calculated as the radius of the axle center minus the radius of the lane center.

### Lateral Load Transfer Ratio

This was a measure of the roll stability of the vehicle. It was the amount of vertical load that was transferred from the tires on the axle end on the inside of the curve to those on the outside. Mathematically, the formula for calculating the Lateral Load Transfer Ratio of an axle is shown in **Equation C1**.

$$\text{LTR} = \frac{|\text{FR}-\text{FL}|}{\text{FR}+\text{FL}} \quad (\text{C1})$$

where

FL is the force on the left side tires and

FR is the force on the right side tires.

When an evenly loaded vehicle is driving straight on level road, the ratio is 0. When the load on one end of the axle is completely removed, the ratio is 1. A ratio of 1 does not necessarily mean the vehicle rolled over. Whether a vehicle actually rolls over depends on its roll rate, how long the vehicle remains in the curve, and other factors.

The Lateral Load Transfer Ratio was calculated as a function of time for all axles. The peak value for each axle was extracted. The rearmost axle had the worst ratio in all cases.

The lateral load transfer has a steady-state value while the vehicle is at a steady speed in the curve, and the quantity begins to decrease when the brakes are applied. In nearly every case, the quantity reported was the steady-state value. The figures in Appendix F show a transient about 1 second after the brakes were applied. In only one case did the transient exceed the steady pre-braking value, but then only minimally.

### Maneuver 5. Avoidance Maneuver

The procedure to evaluate rearward amplification properties was based on the single lane change maneuver in ISO 14791 (ISO 2000).

#### *Path Description*

The path began with a straight segment for 350 ft., long enough to establish stable motion. The maneuvering section of the path is a single lane change. Section 7.5.2 of the standard calls for the steering input to be followed by 5 seconds of neutral steering.

The standard allows either an open-loop hand wheel input (7.5.2) or closed-loop path (7.5.3) to effect the lane change. Maneuvers were run with closed-loop path-following control. The TruckSim<sup>®</sup> driver model's preview time was set to 0.15 seconds, which was found to yield the best results. The expression for the closed-loop path is

$$y = \frac{a}{\omega^2} \cdot \left[ \omega \cdot \frac{x}{v} - \sin \left( \omega \cdot \frac{x}{v} \right) \right] \tag{C2}$$

where

y is the lateral position

a is the desired peak lateral acceleration

$\omega$  is the frequency of excitation

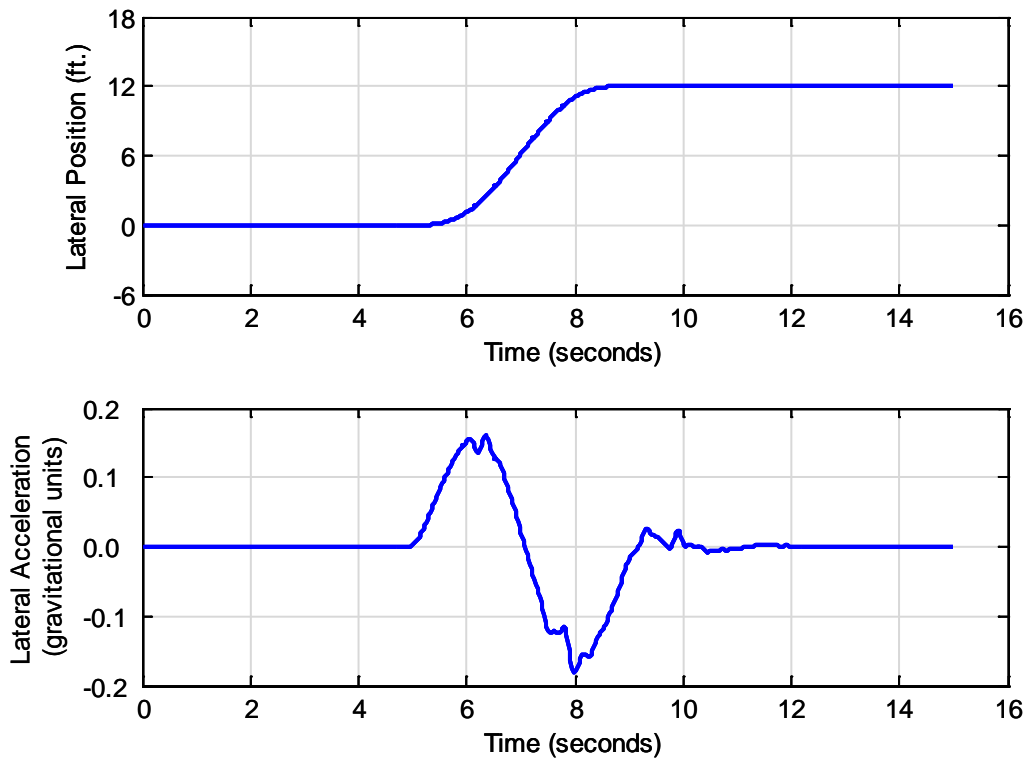
x is the distance traveled down range (“station”)

v is the forward speed of the vehicle.

The quantity  $\omega \cdot x/v$  ranges from 0 to  $2\pi$  to provide one cycle of lateral acceleration input.

**Figure C5** shows a typical path of a simulated tractor and the corresponding lateral acceleration.

**Figure C5. Control Double Vehicle Path While Executing the 12-ft. Lane Change Maneuver**



Section 7.3 recommends a peak lateral acceleration of 2 meters/second<sup>2</sup> (approximately 0.2 gravitational units) but permits a lower maximum when appropriate. A peak of 0.15 gravitational units was selected for this study.

The peak lateral acceleration and frequency of the maneuver vary slightly from the ideal quantities in **Equation C2** because the TruckSim<sup>®</sup> driver model does not perfectly follow the

intended path (although the greatest imperfection in any of the runs was 1.6 in.). The resulting spread of frequencies was sufficient to identify a peak response in the measured quantity in nearly every case. The actual peak acceleration amplitude ranged from 0.13 to 0.19 gravitational units, so the tests were satisfactory.

This is the only scenario that needed iteration: Section 7.5.1 of the standard calls for the test to be conducted for at least three frequencies to find the maximum rearward amplification. Runs were conducted at eight frequencies. With the peak acceleration fixed, then the frequency and lateral offset are inversely related:

$$\omega = \sqrt{\frac{a}{\Delta y}} \cdot 2\pi \quad (C3)$$

Eight paths were developed following **Equation C2**. The offset of the lane change (y at the end of the maneuver) ranged from 3 ft. to 24 ft. as listed in **Table C1**. The desired peak lateral acceleration (a) was 0.15 gravitational units and the forward speed (v) was 50 mph in all cases. The resulting frequency of excitation ( $\omega/(2\pi)$ ) of each path and the longitudinal distance required to complete the path ( $\Delta x$ ) are also listed in the table.

**C1. Parameters for the Paths to Simulate the Avoidance Maneuver.**

| Path Number | Lane Change Offset,<br>$\Delta y$ (ft.) | Excitation Frequency,<br>$\omega/(2\pi)$ (Hertz) | Longitudinal<br>Distance, $\Delta x$ (ft.) |
|-------------|---|--|--|
| 1           | 3                                       | 0.51   | 145  |
| 2           | 6                                       | 0.36   | 205  |
| 3           | 9                                       | 0.29   | 251  |
| 4           | 12                                      | 0.25   | 290  |
| 5           | 15                                      | 0.23   | 324  |
| 6           | 18                                      | 0.21   | 355  |
| 7           | 21                                      | 0.19   | 383  |
| 8           | 24                                      | 0.18   | 410  |

***Speed***

This maneuver was conducted at a constant speed of 50 mph.

***Analysis***

These runs were analyzed for three quantities—off-tracking, rearward amplification of lateral acceleration and lateral load transfer ratio. Every vehicle was run through the eight lane changes in **Table C1**. The three analysis quantities were calculated at each of the eight lane change distances, corresponding to eight excitation frequencies as in the table. The highest of these eight values was reported as the result in **Table 29** of the main text. Graphs of all quantities are in **Appendix E**.

### Off-tracking

Section 8.3 of the standard defines off-tracking for the maneuver. The analysis followed the path of the steer axle, which was the baseline from which deviations were measured. The analysis is illustrated in **Figure C6**. In text form, the analysis was as follows:

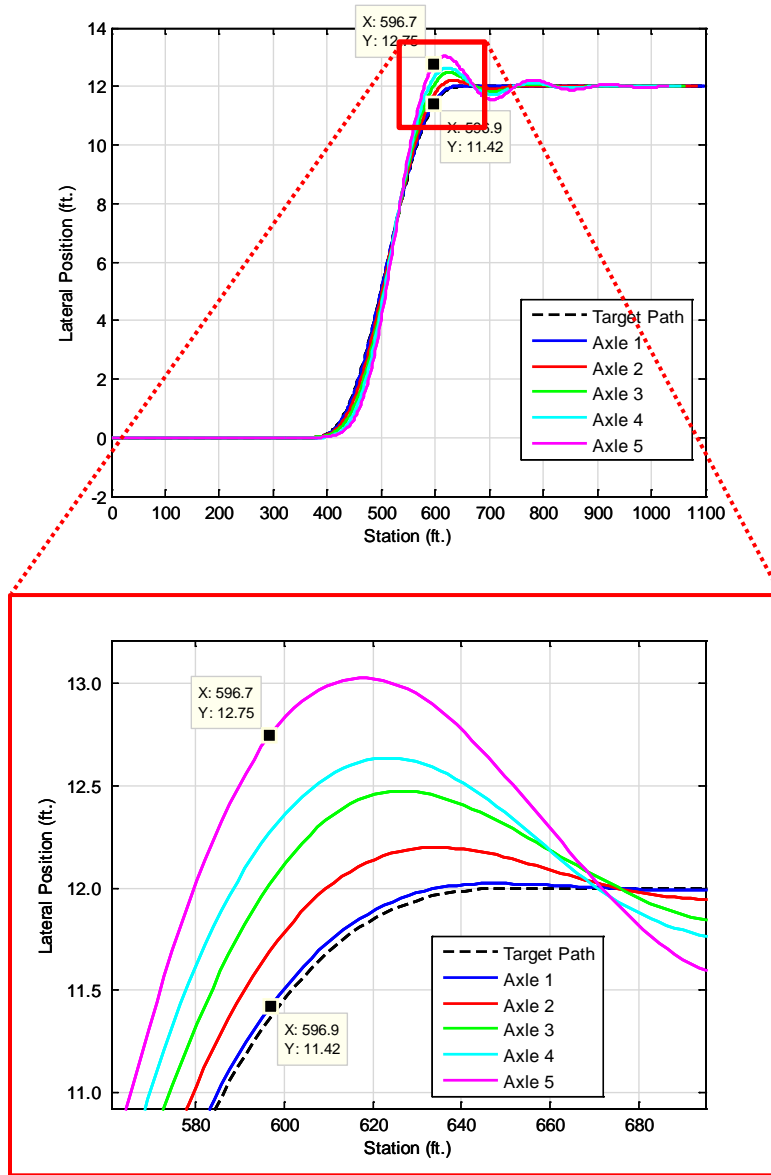
1. For each point on the steer axle path, find the off-tracking of all the trailing axles.
2. For each trailing axle, find the point whose X value (station) is closest to the X value of the steer axle position. Compute the difference in Y values (lane position) of the trailing axle and the steer axle.
3. The result is an array with one column for each trailing axle and one row for each station position considered. The highest value in the array is the worst off-tracking of the truck in this scenario.

**Figure C6** plots the path of each axle center for a 12-ft. lane change for the control double vehicle. Off-tracking was computed as the difference in Y values (lane position) of each trailing axle from the steer axle. The worst off-tracking of the truck at this excitation frequency was 12.75 - 11.42 or 1.33 ft., which was reported as 16 in. This process was repeated for the eight excitation frequencies in order to find the global highest absolute off-tracking value.

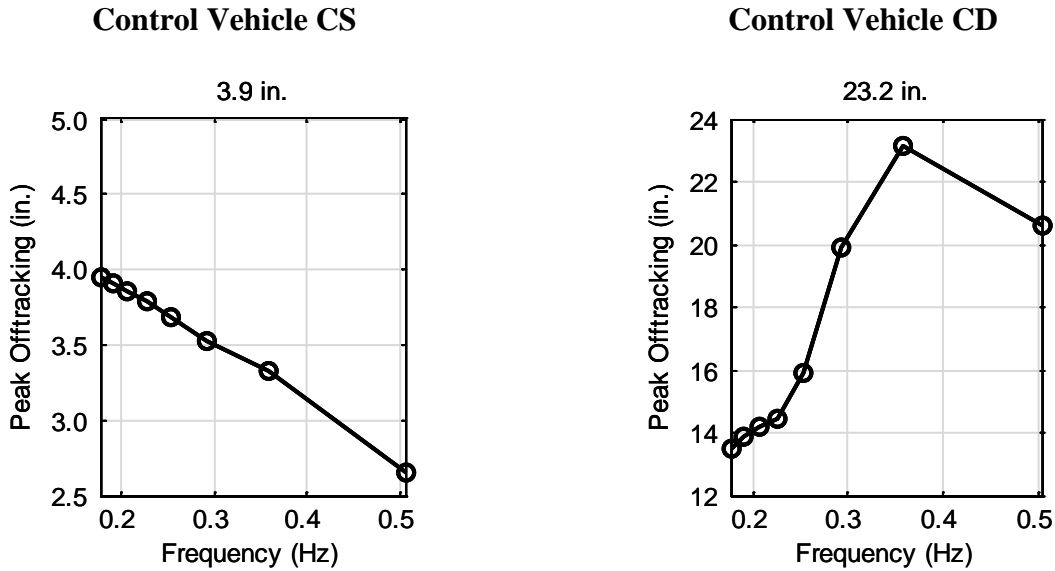
**Figure C7** plots peak off-tracking for the control single and control double vehicles for all eight excitation frequencies listed in **Table C1**. The graph shows that the control double vehicle demonstrated peak off-tracking of 23.2 in. at an excitation frequency of 0.36 Hz, which was the 6-ft. lane change.



Figure C6. Control Double Vehicle Off-tracking Calculation for the 12-ft. Lane Change



**Figure C-7. Maximum Off-tracking for All Excitation Frequencies**

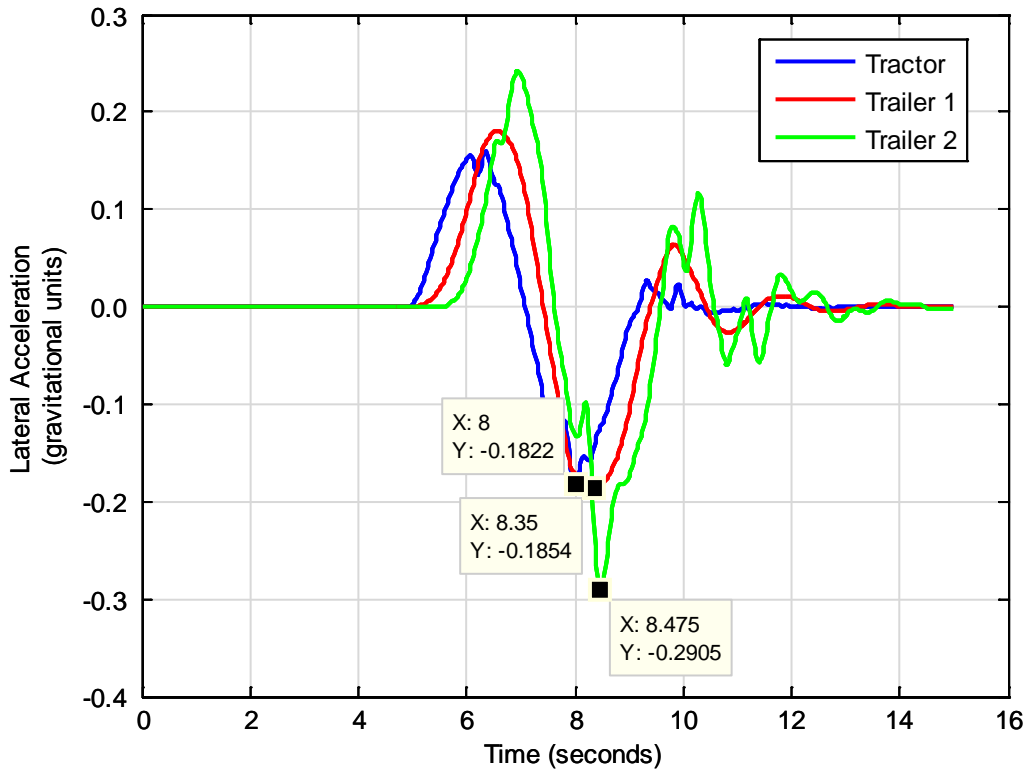


Rearward Amplification

**Figure C8** shows the lateral acceleration time histories of the tractor and two trailers of the control double vehicle in the 12-ft. lane change. Markers in the figure identify the maximum of each unit’s acceleration. The rearward amplification is the ratio of the peak lateral acceleration of the rear trailer to that of the tractor.

A low-pass digital Butterworth filter (fourth order filter, 5-Hz cutoff frequency) was applied to the TruckSim® lateral acceleration output data to attenuate high-frequency spikes in the data.

**Figure C8. Rearward Amplification Reflected by Peak Lateral Acceleration in Trailers**

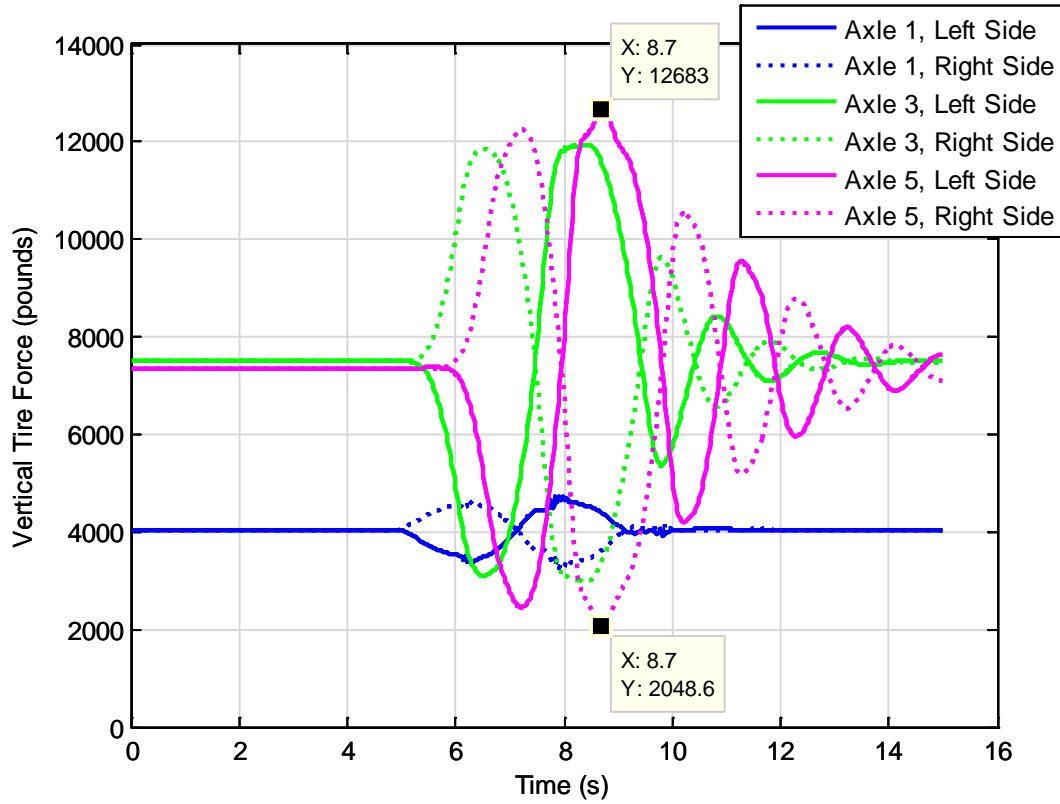


Lateral Load Transfer Ratio

Load transfer ratio was calculated in the same manner as it was for the brake-in-a-curve maneuver, using **Equation C1**.

**Figure C9** plots the vertical forces on the tires for a 12-ft. lane change for the control double vehicle. (These are forces on the axle end. The steer tires have the forces plotted; other axles have dual tires so the force on each tire is half of the value.) The peak Lateral Load Transfer Ratio occurred at a peak in the path, as shown in this figure.

**C9. Shifts in Vertical Tire Force Over Time Reflect Vehicle “Leaning” during the Modeled Avoidance Maneuver.**



## APPENDIX D. MODELS FOR THE VEHICLE STABILITY AND CONTROL ANALYSIS

The basic configurations of the control and study vehicles were selected by the U.S. Department of Transportation. The number and length of trailers, the number and position of axles, and the maximum allowable gross vehicle weight were decided for the contractor team and were common across all analysis tasks.

Within this guidance, the USDOT study team developed simulation models for evaluating vehicle performance. The models consist of a set of properties (dimensions, weights, compliances, and so forth) that are entered in TruckSim<sup>®</sup> as a set of parameters.

This appendix documents the sources of the data that were used to construct the models and the decision processes for applying them.

### **Basic Vehicle Model**

The model for the single-trailer control case was based on a model that was experimentally verified for a number of maneuvers in prior work. The other seven models were built by modifying this original model as necessary to, for example, add an axle or change the length of a trailer. Properties have been compared with industry values where possible, but the new models have not been separately verified.

### **Single-Trailer Models**

The tandem-axle tractor model was based on a 2006 Volvo 6x4 model VNL64T630, and the tandem-axle trailer on a 1992 Fruehauf box trailer. The parameters for this configuration were obtained from a model developed for the National Highway Traffic Safety Administration (Rao et al. 2013b). That reference describes the measurements of the vehicle's properties and documents how they were modeled in TruckSim<sup>®</sup>. For both the tractor and trailer, there were measurements of mass and inertia, suspension compliance and geometry, tires, and brakes.

Although the parameters were obtained from previously published work, simulations were performed to compare the results with previously published validation work (Rao et al. 2013a) to ensure the model was properly implemented. Two maneuvers were used to verify the model, slowly increasing steer at constant speed and ramp steer with drop-throttle. Steering angle, longitudinal speed, lateral acceleration, and yaw rate all were compared for both maneuvers.

### ***Payloads in the Single-Trailer Combinations***

The payload in each of the single-trailer combinations consisted of blocks of equal height. Both blocks had uniform density and together they filled the 53-ft. floor area of the semitrailer. The relative densities and lengths of the two blocks were chosen to achieve the target axle loads in **Table B3** of the Project Plan (**Appendix B**). The payloads in both the single- and multiple-trailer vehicles had a width of 99 in.

The starting point to determine the payload properties was the 97,000-lb., six-axle 3-S3 vehicle for Scenario 3. The relative densities of the two payload blocks and their relative sizes were chosen such that volume of the 53-ft trailer was completely filled. The densities of the two

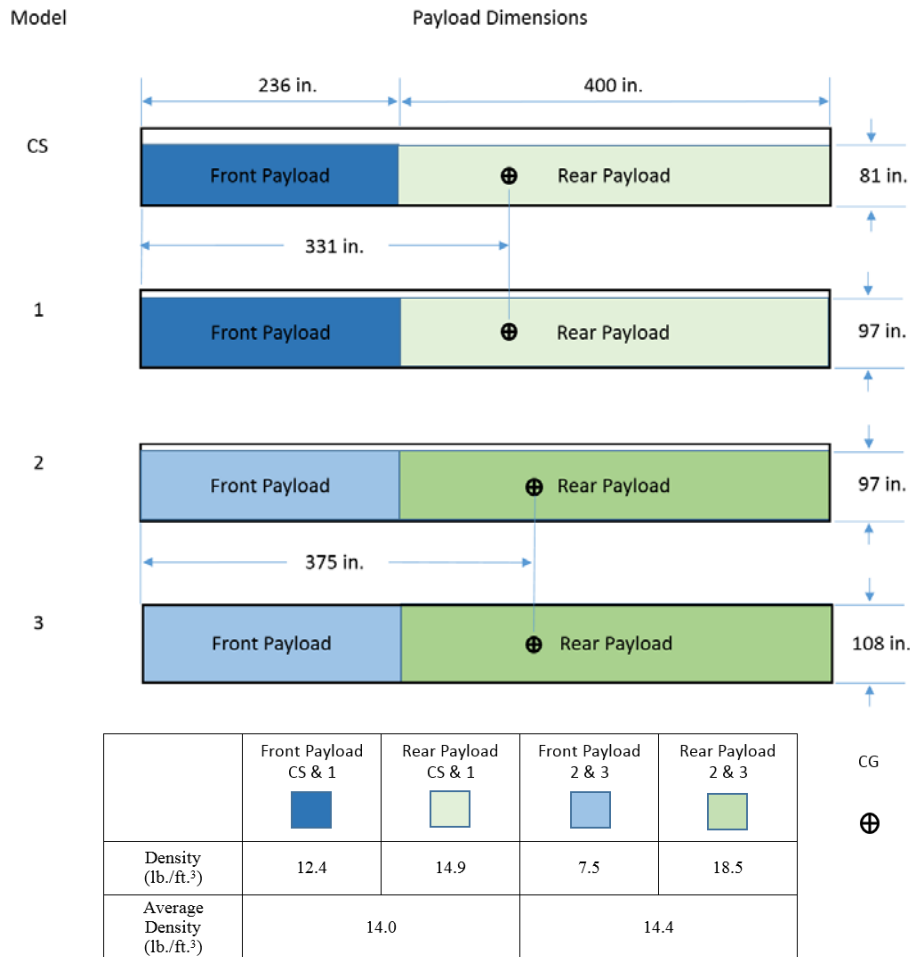
blocks were retained but their heights were reduced to produce the 91,000-lbs. gross vehicle weight of Scenario 2.

To maintain a reasonably uniform axle load on the five-axle combinations of the control single vehicle and Scenario 1, the densities of the two payload blocks were recalculated to move the center of gravity forward. Again, the payload height was reduced to decrease the gross vehicle weight from 88,000 lbs. to 80,000 lbs.

Axle weights in the empty and loaded conditions for all eight vehicles were measured by simulating a straight drive at 5 mph. The gross vehicle weights of the four single-trailer combinations were all within 0.5 percent of the target values.

**Figure D1** shows the payload properties for all the single-trailer combinations. The size of payloads, dimensions and CG locations are not to scale.

**Figure D1. Dimensions of Payloads on the Single-Trailer Combinations**



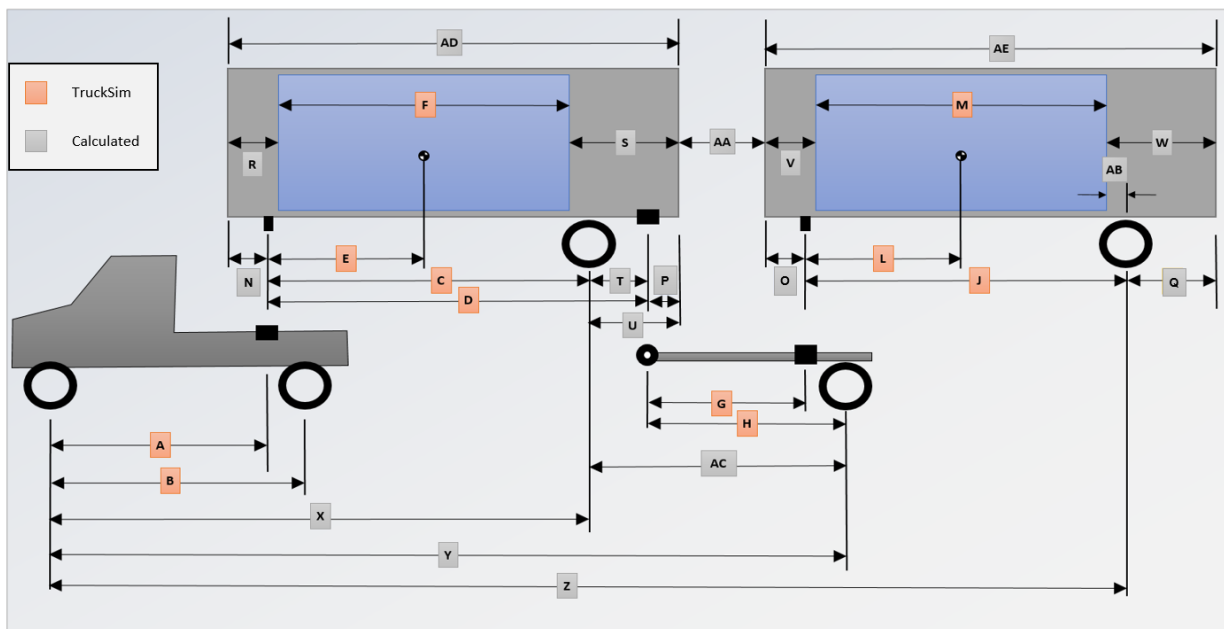
**Multi-Trailer Combination Models**

The multi-trailer combination models were developed with a combination of available published data and TruckSim<sup>®</sup> default parameters. Suspension and brake parameters for all axles were retained from the experimentally verified values used for the single-trailer combinations. The tandem-axle tractor was also the same as the tractor used in the single-trailer combinations. Any properties that were unique to multi-trailer combinations such as the sprung masses and moments of inertia for the single axle tractor, 28-ft. trailer and 33-ft. trailer were obtained from TruckSim<sup>®</sup> defaults.

**Trailer-to-Trailer Spacing for Multi-Trailer Combination**

**Figure D2** and **Table D2** present the longitudinal positions of the axles and other key components of the models. Dimensions of the pintle hitch and dolly for multi-trailer combinations were based on industry standards (SAE International 2013 and SAE International 2014).

**Figure D2. Trailer-to-Trailer Spacing Schematic**



**Table D2. Trailer-to-Trailer Spacing Key Dimensions**

| 28-ft.<br>trailers | A       | B       | C       | D       | E       | F       | G       | H       | J       | L       | M       | N       | O       | P       | Q  |
|--------------------|---------|---------|---------|---------|---------|---------|---------|---------|---------|---------|---------|---------|---------|---------|----|
|                    | 15<br>7 | 15<br>8 | 26<br>4 | 29<br>8 | 13<br>5 | 33<br>0 | 74      | 75      | 26<br>4 | 13<br>5 | 33<br>0 | 36      | 36      | 2       | 36 |
|                    | R       | S       | T       | U       | V       | W       | X       | Y       | Z       | AA      | AB      | AC      | AD      | AE      |    |
|                    | 6       | 0       | 34      | 36      | 6       | 0       | 42<br>1 | 53<br>0 | 79<br>3 | 36      | -36     | 10<br>9 | 33<br>6 | 33<br>6 |    |

| 33-ft.<br>trailers | A       | B       | C       | D       | E       | F       | G       | H       | J       | L       | M       | N       | O       | P       | Q  |
|--------------------|---------|---------|---------|---------|---------|---------|---------|---------|---------|---------|---------|---------|---------|---------|----|
|                    | 15<br>7 | 15<br>8 | 32<br>4 | 35<br>8 | 16<br>6 | 38<br>7 | 74      | 75      | 32<br>4 | 16<br>6 | 38<br>7 | 36      | 36      | 2       | 36 |
|                    | R       | S       | T       | U       | V       | W       | X       | Y       | Z       | AA      | AB      | AC      | AD      | AE      |    |
|                    | 9       | 0       | 34      | 36      | 9       | 0       | 48<br>1 | 59<br>0 | 91<br>3 | 36      | -36     | 10<br>9 | 39<br>6 | 39<br>6 |    |

All dimensions are in inches.

**Multi-Trailer Combination Payloads**

Given the tare weights of the unloaded vehicle, computing the necessary payload masses to achieve the target total axle loads is straightforward. Only a single payload was needed in each trailer.

The controlling case for determining the payload density was the 33-ft. trailers in Scenario 4. A payload of approximately 700 lbs. per longitudinal ft. in the trailer brought the gross vehicle weight up to the allowed 80,000 lbs. This same payload density was put in the two 28-ft. trailers of the control double vehicle and the three 28-ft. trailers of Scenario 5. Adjustment was made to the payload floor area by dimensions “R” and “V” in **Table D2** to achieve individual target axle loads as shown in **Figure 4** of the main text.

The 129,000-lb. loading and nine-axle configuration of the Scenario 6 were sufficiently different from the other vehicles that payloads were applied to bring all axle loads close to their targets and the gross vehicle weight to within 0.1 percent of the allowed maximum.

**References**

Rao, S.J. et al. (2013a). “Validation of Real Time Hardware in the Loop Simulation for ESC Testing with a 6×4 Tractor and Trailer Models.” SAE Paper 2013-01-0692.

Rao, S.J. et al. (2013b). “Modeling of a 6×4 Tractor and Trailers for Use in Real Time Hardware in the Loop Simulation for ESC Testing.” SAE Paper 2013-01-0693.

SAE International (2014). Truck Tractor Semitrailer Interchange Coupling Dimensions. Surface Vehicle Information Report. J701



SAE International (2013) Connection and Accessory Locations for Towing Multiple Trailers - Truck and Bus. Surface Vehicle Recommended Practice. J849

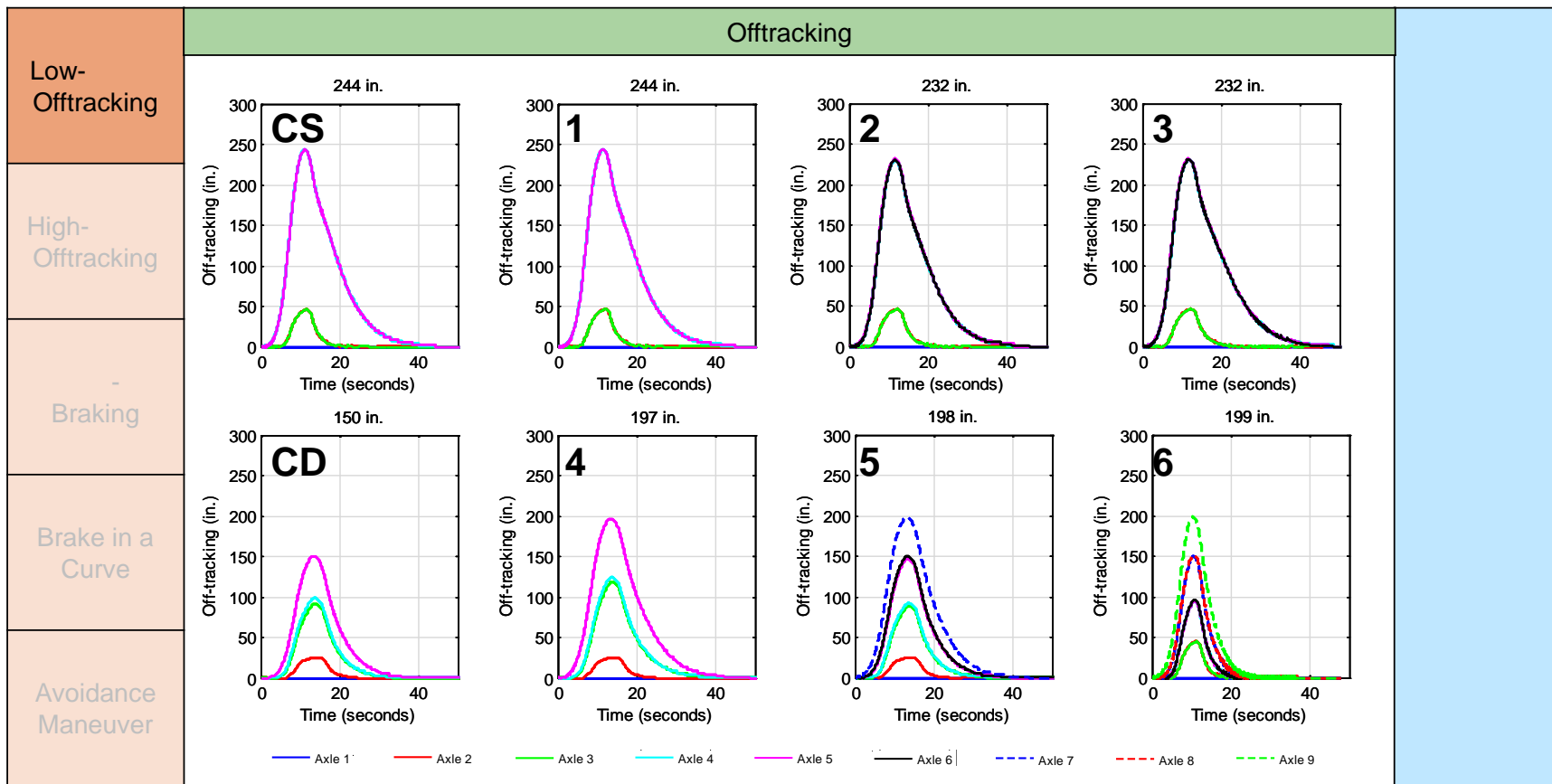
## APPENDIX E. RESULTS OF THE VEHICLE STABILITY AND CONTROL ANALYSIS

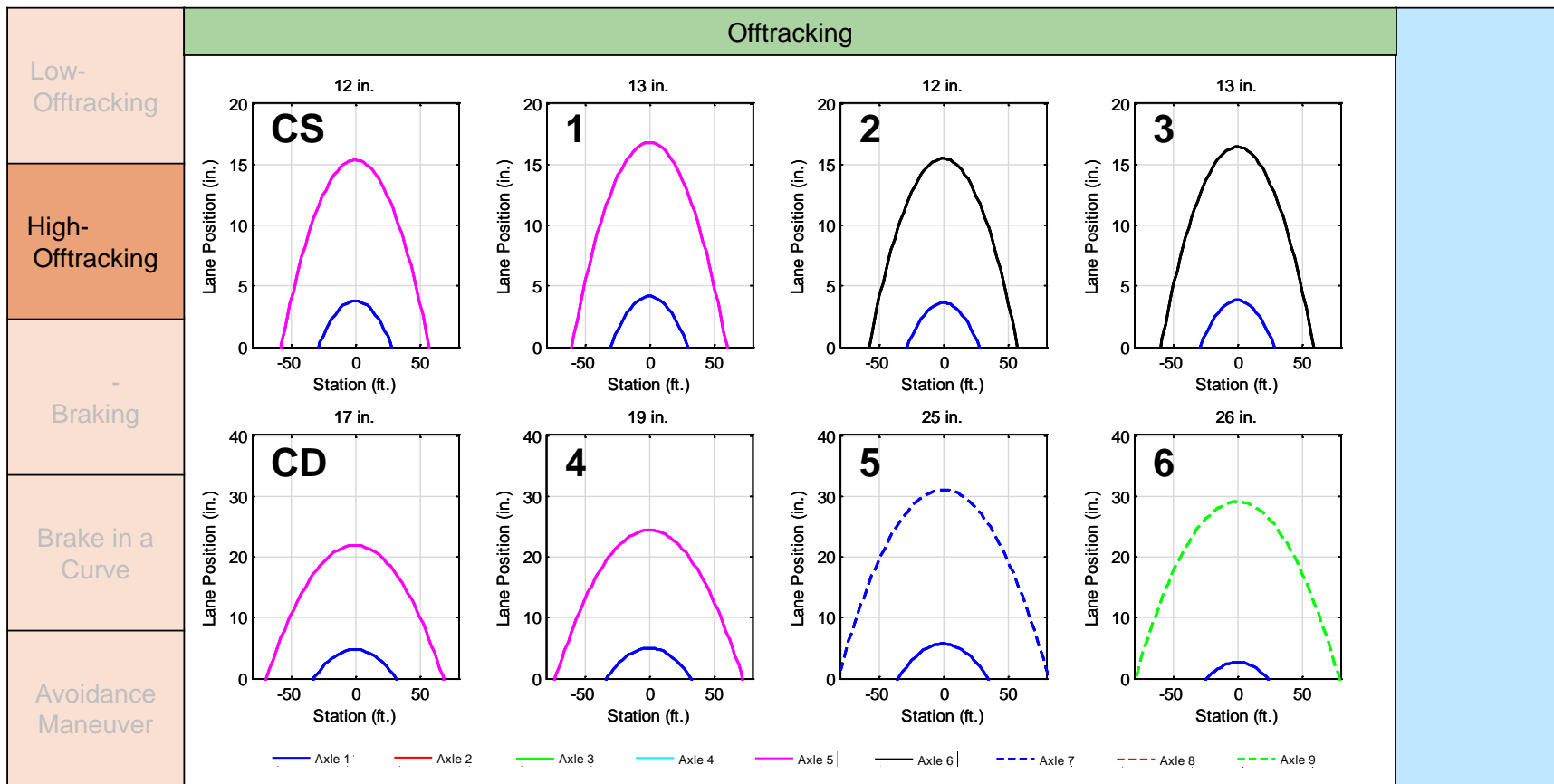
This appendix documents the performance metrics used to study vehicle stability and control for five maneuvers that were simulated in TruckSim<sup>®</sup>. Each run of TruckSim<sup>®</sup> produced an output data file. These files were analyzed with Matlab to calculate the desired performance parameters. **Table 24** in Section 3.2 of the main text lists the performance metrics that were extracted from each of the five maneuvers and the peril that each is intended to assess. **Appendix C** documents how these performance metrics were calculated.

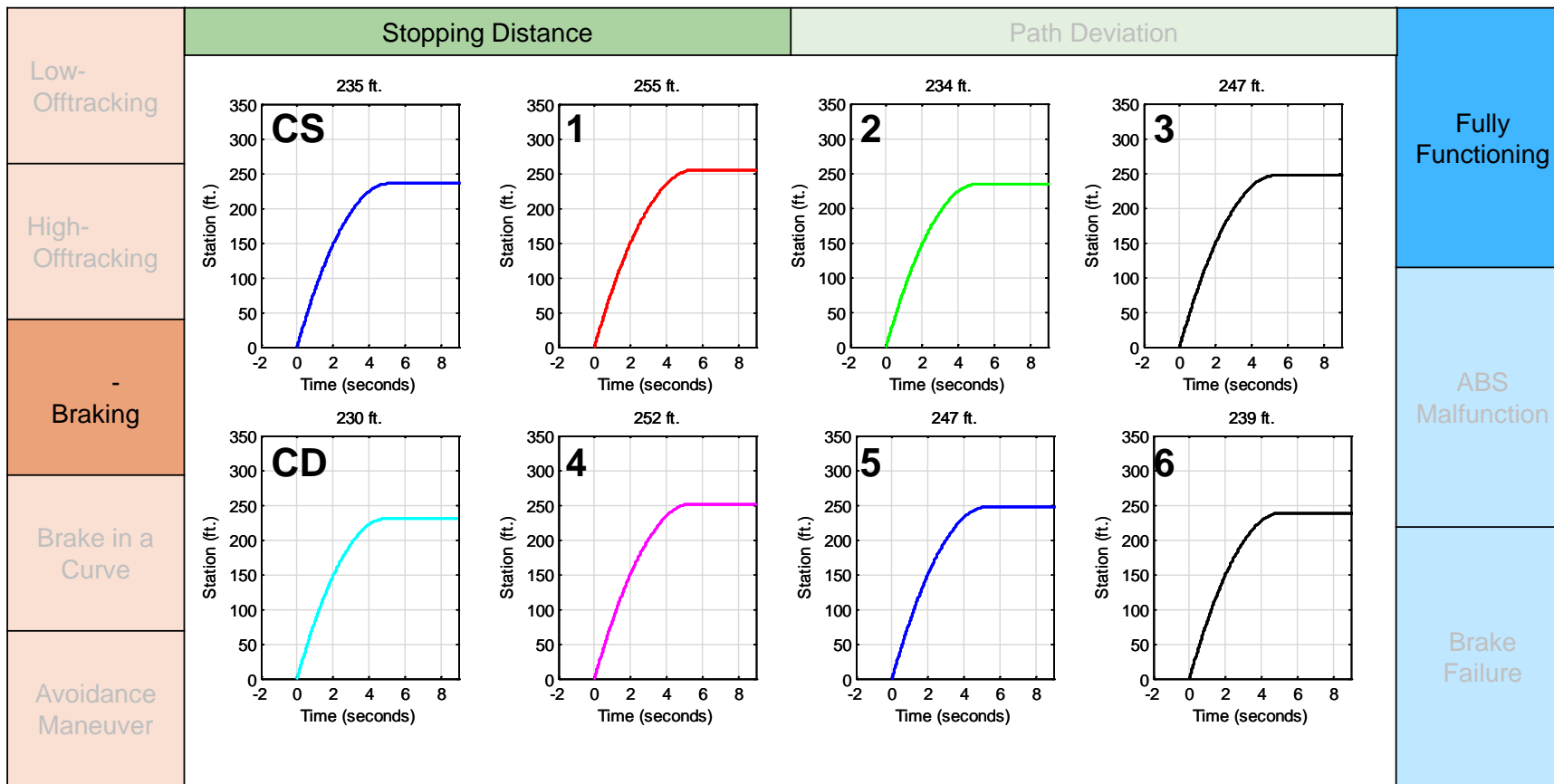
The following pages are graphs of various performance metrics for each simulated test maneuver. On each page, the test maneuver is indicated on the left, the performance metric is indicated on the top, and additional test parameters such as brake failure is indicated on the right. The eight plots on every page correspond to the eight vehicle configurations under investigation.

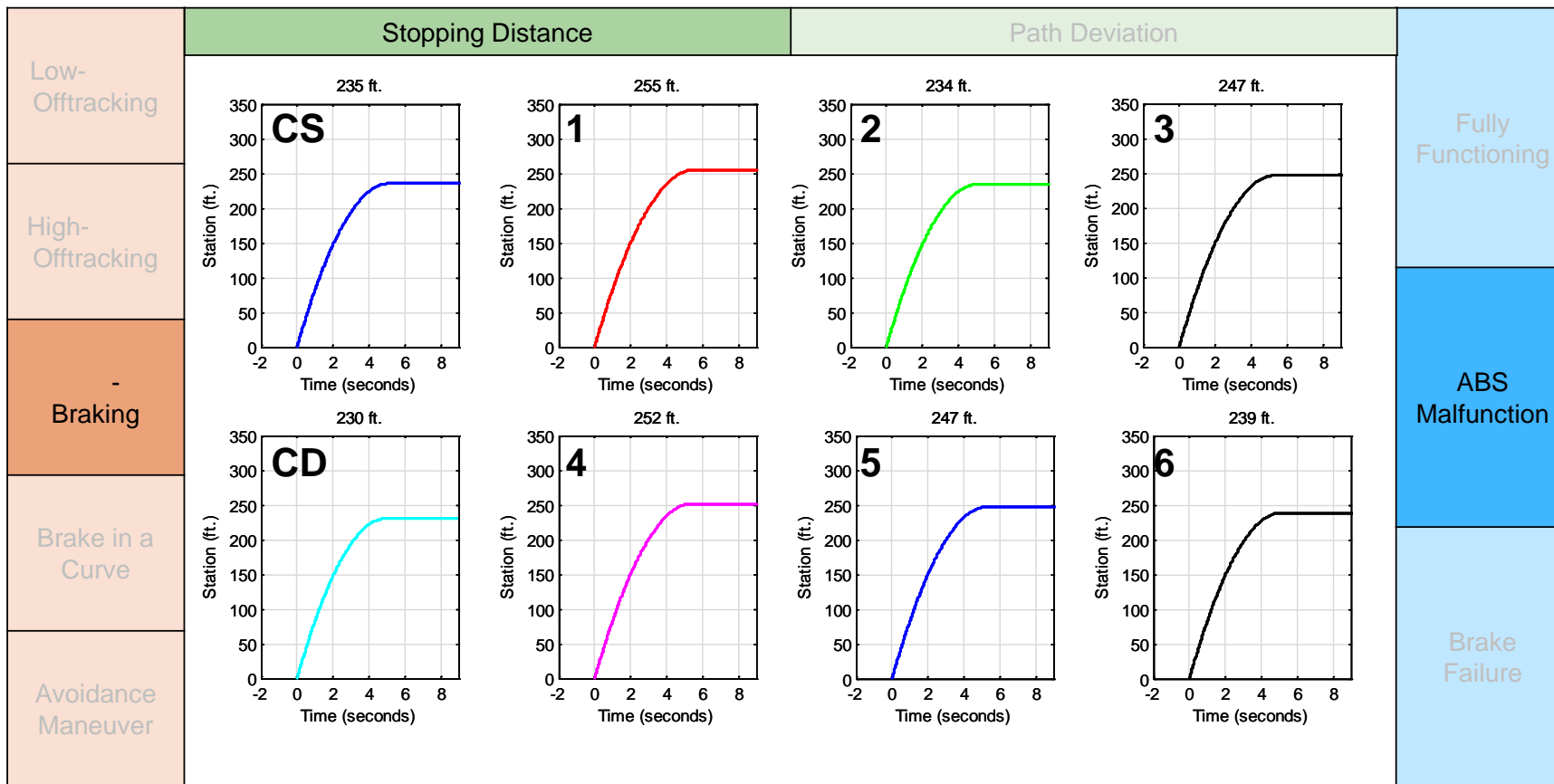
The value above the plot is the result of the simulation. It is the number in the corresponding table of results in Section 3.3 of the main text.

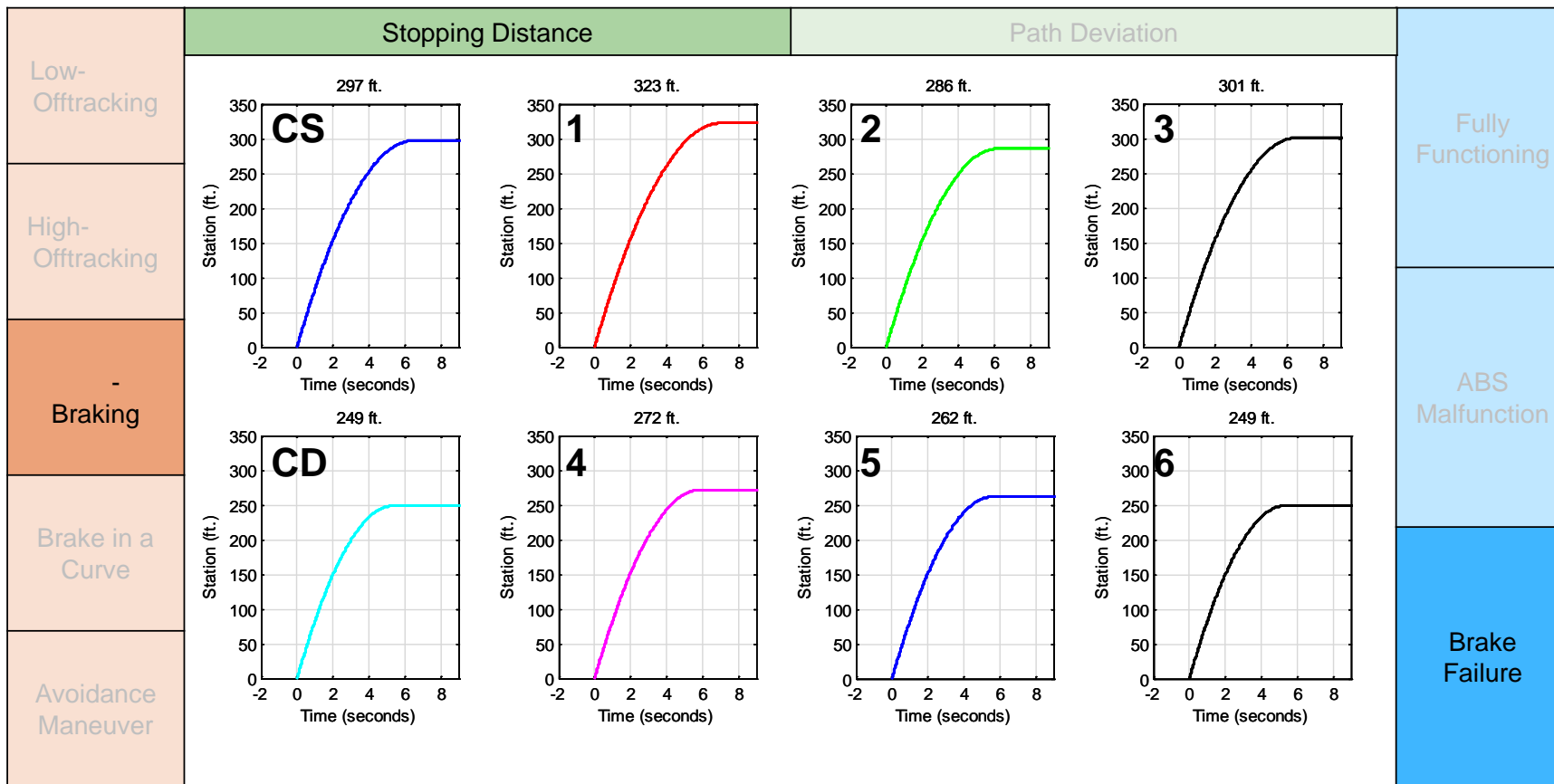
The avoidance maneuver required a family of similar paths. Specifically, eight lane change widths (3, 6, 9, 12, 15, 18, 21, and 24 ft.) were simulated. These eight lane changes correspond to eight excitation frequencies, as shown in **Table C1** in **Appendix C**. From these eight excitation frequencies, the highest responses (i.e. peak off-tracking, peak rearward amplification, and peak load transfer ratio) are reported in this appendix and in **Table 29** of the main text.

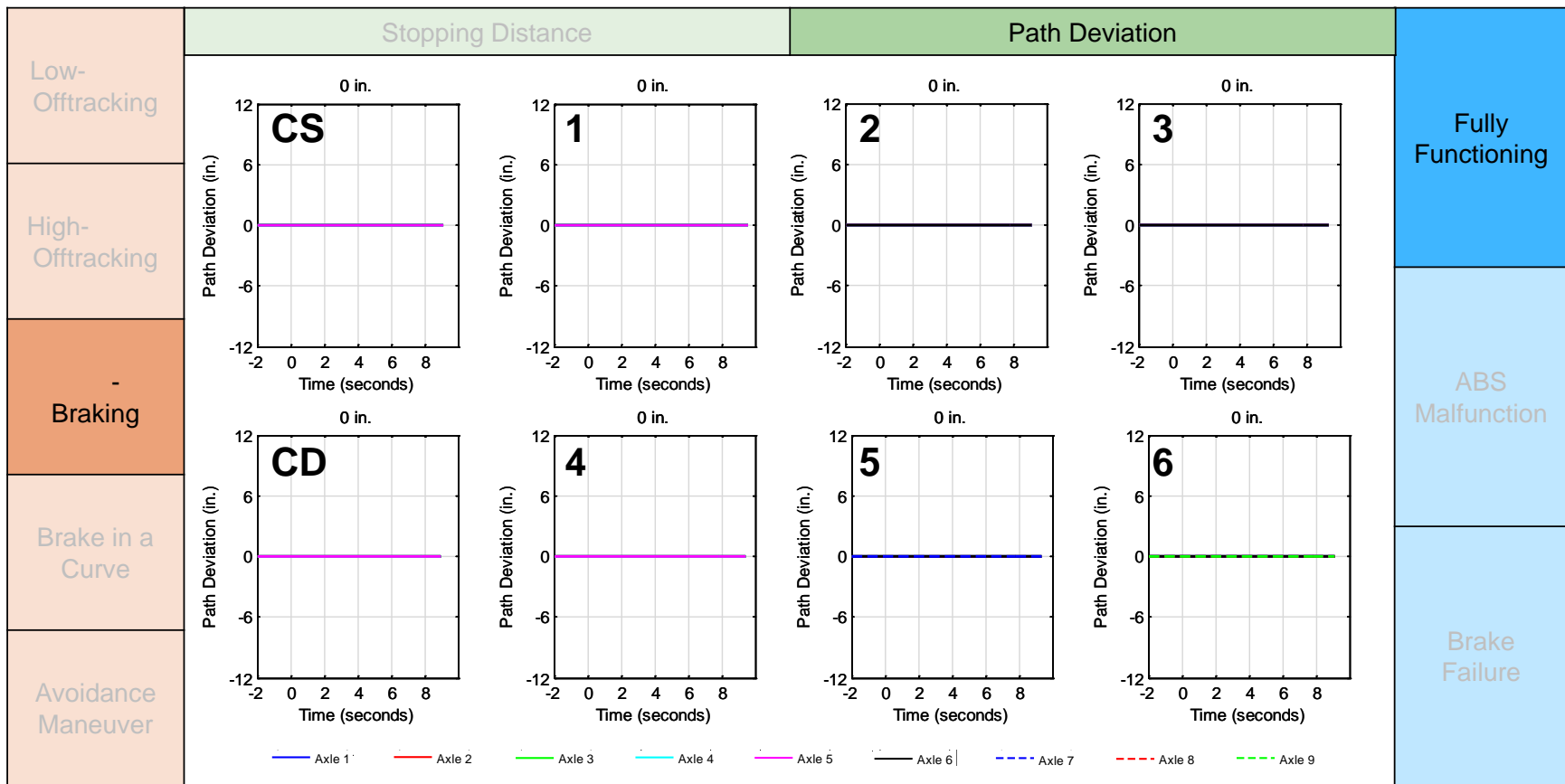




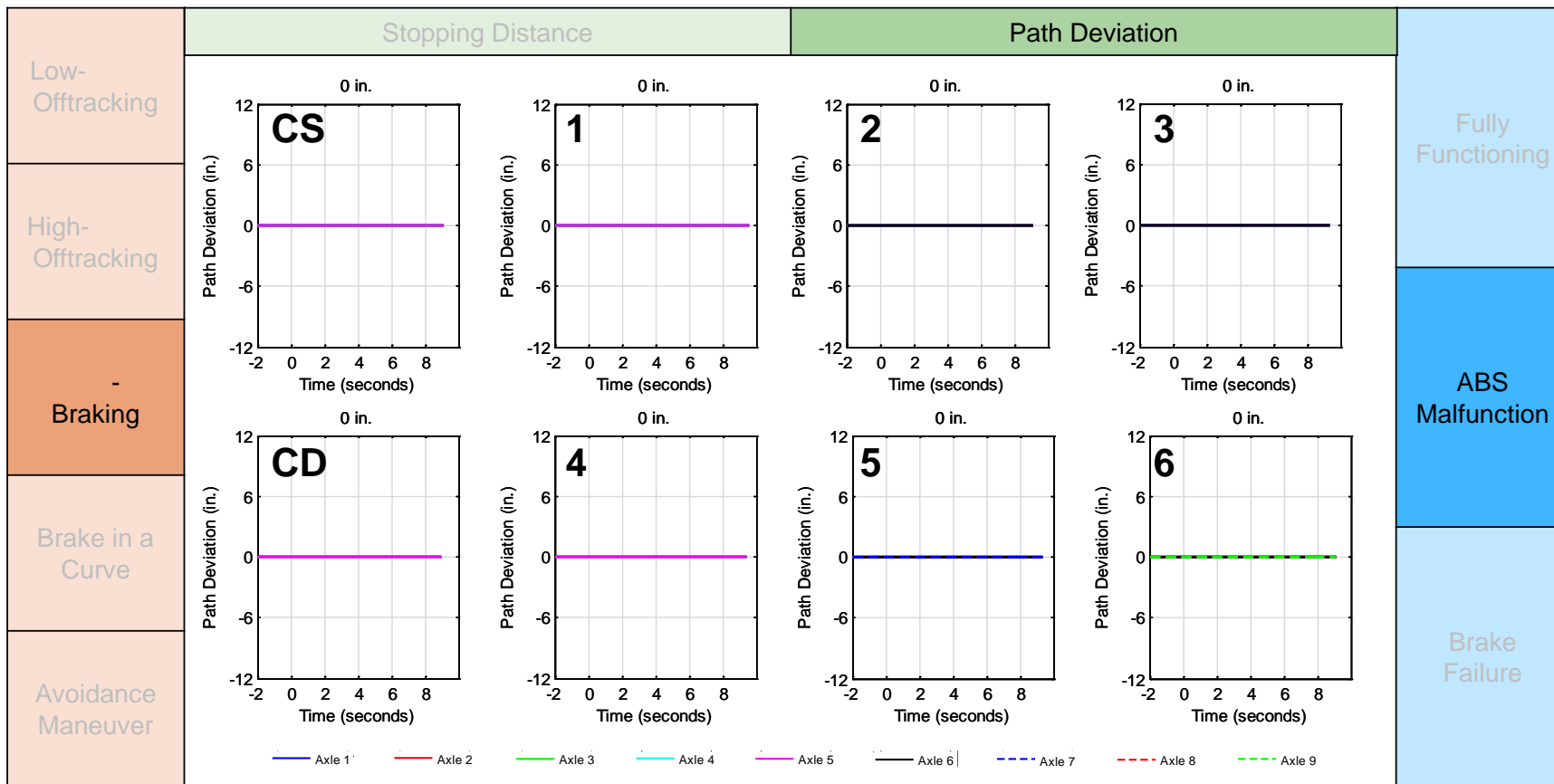


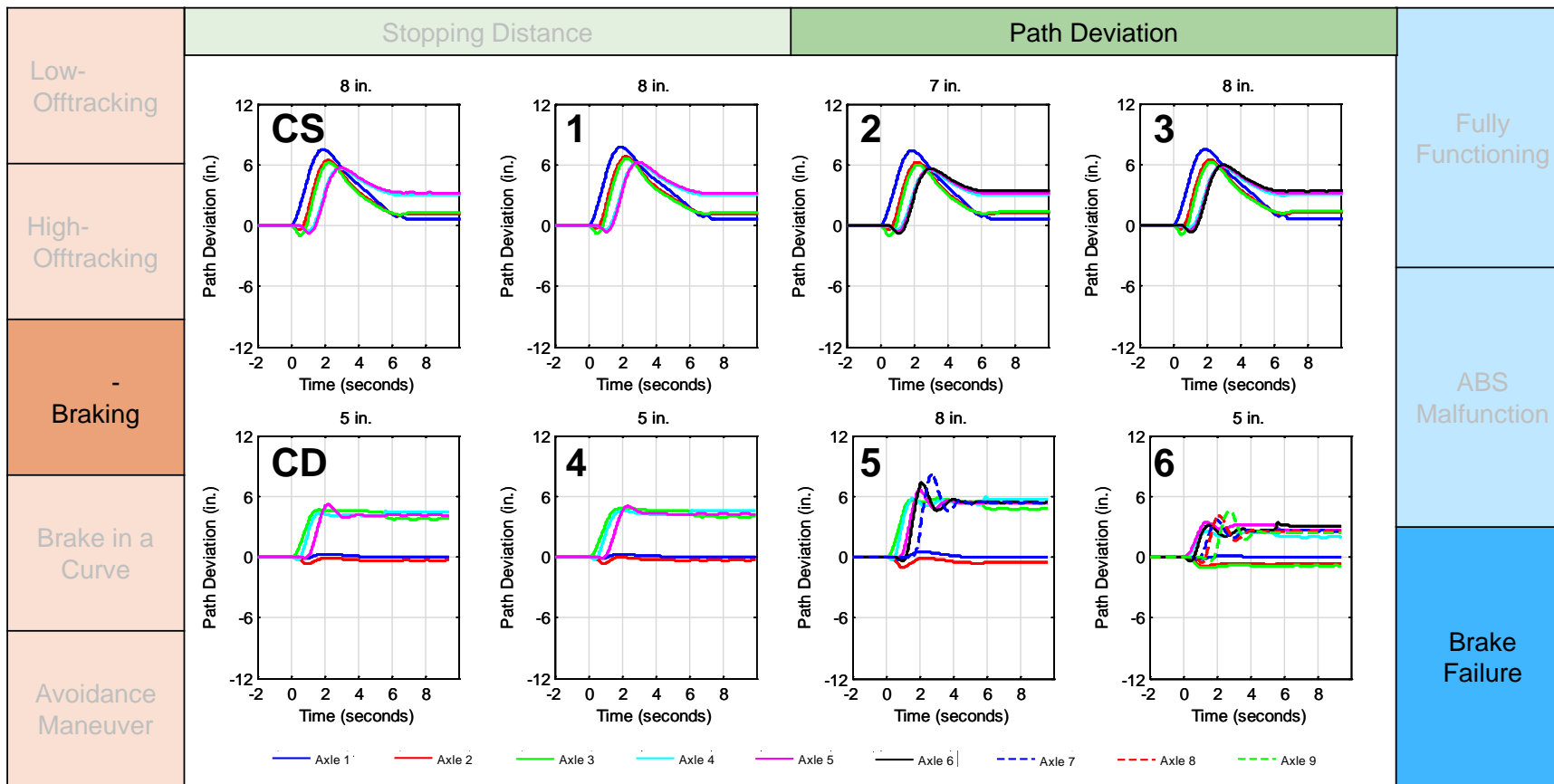


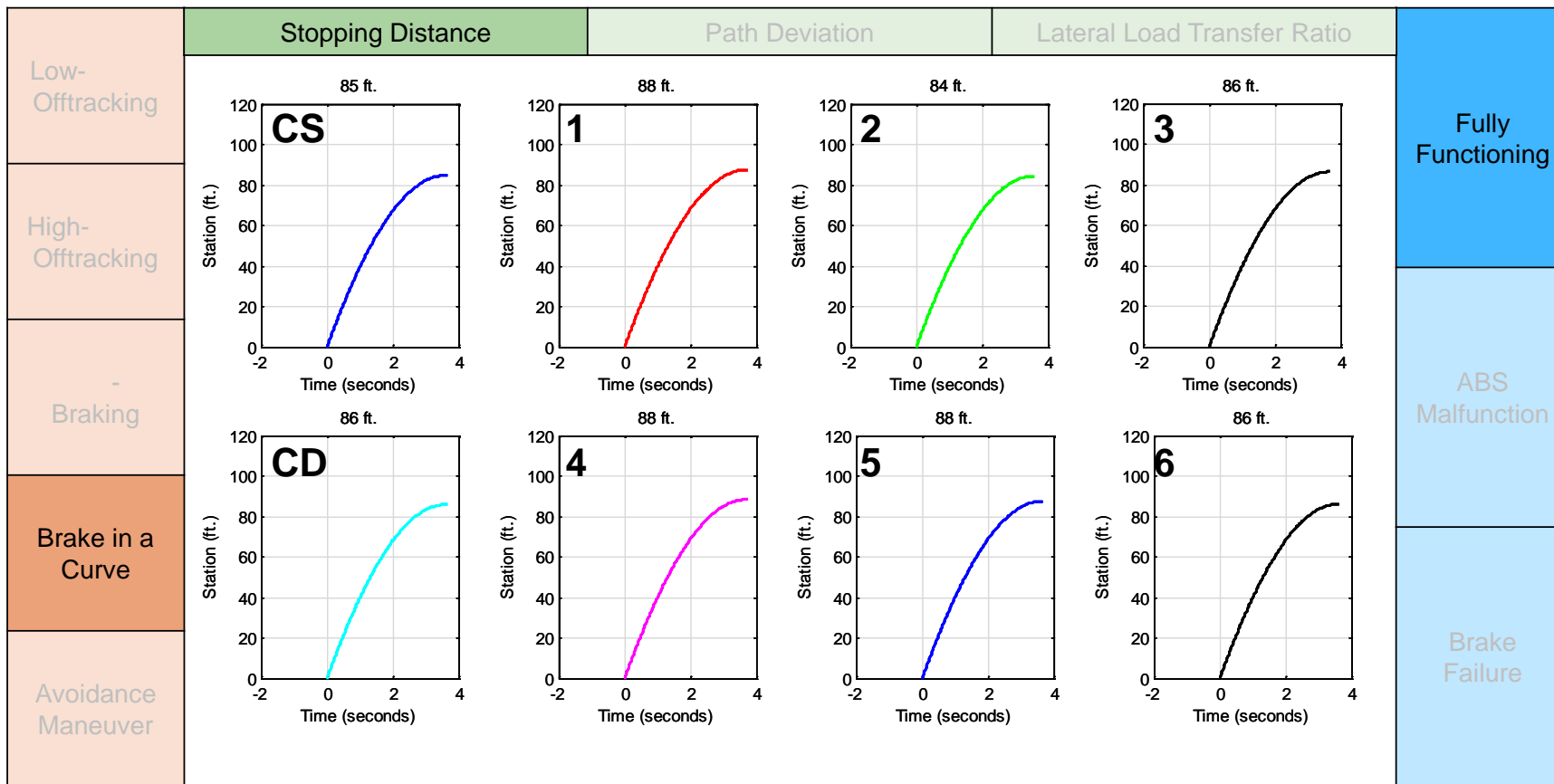


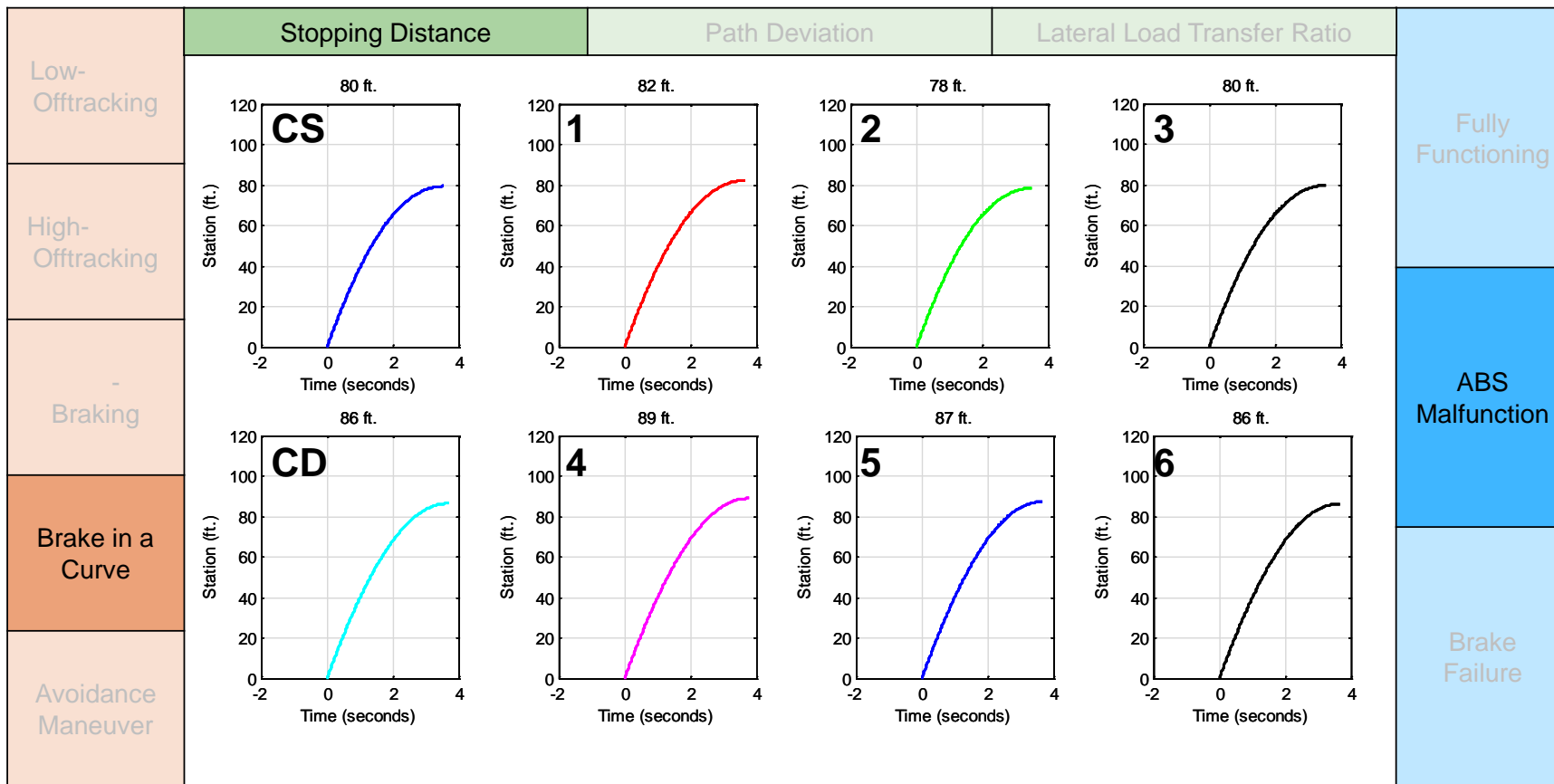


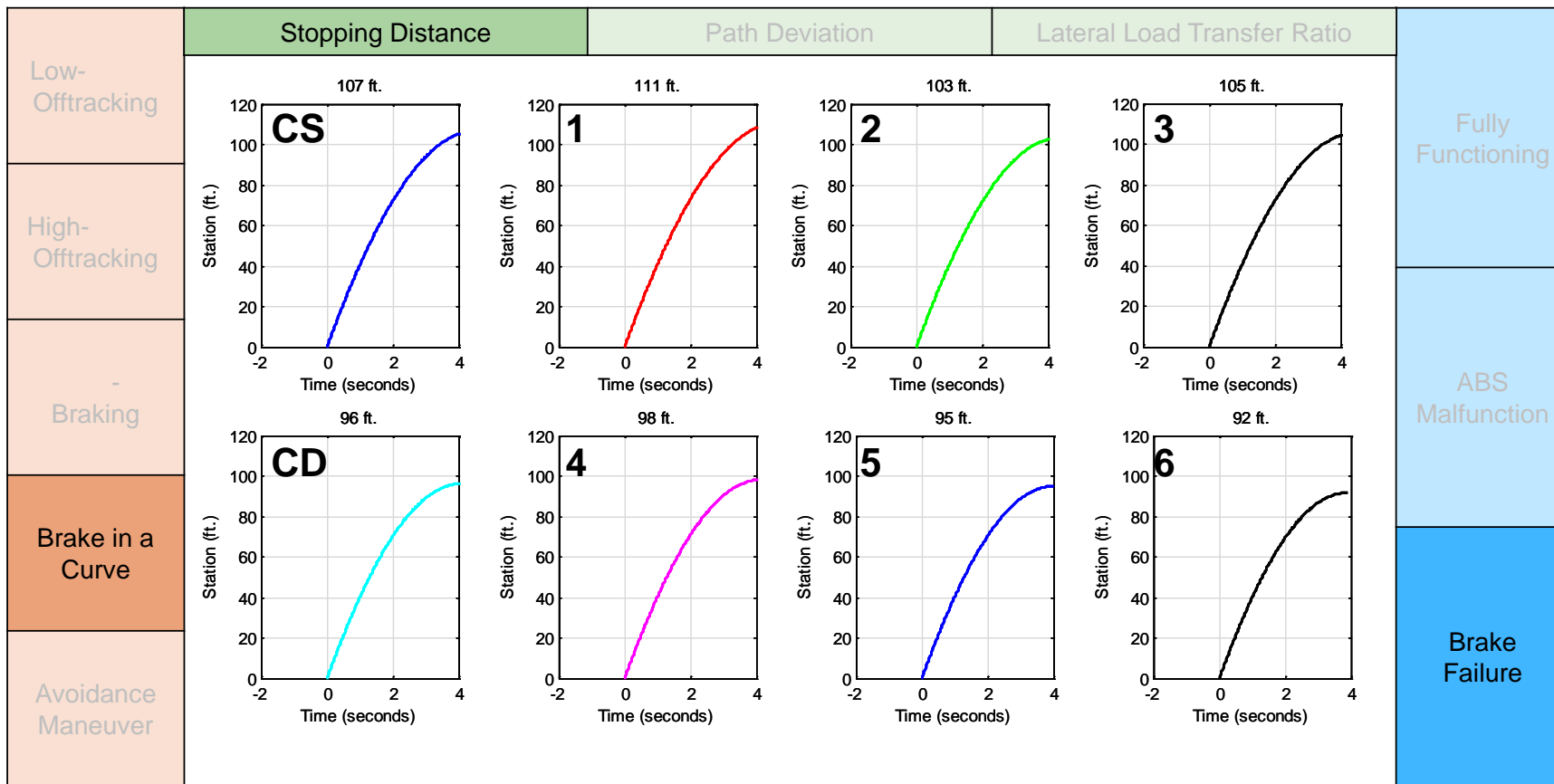


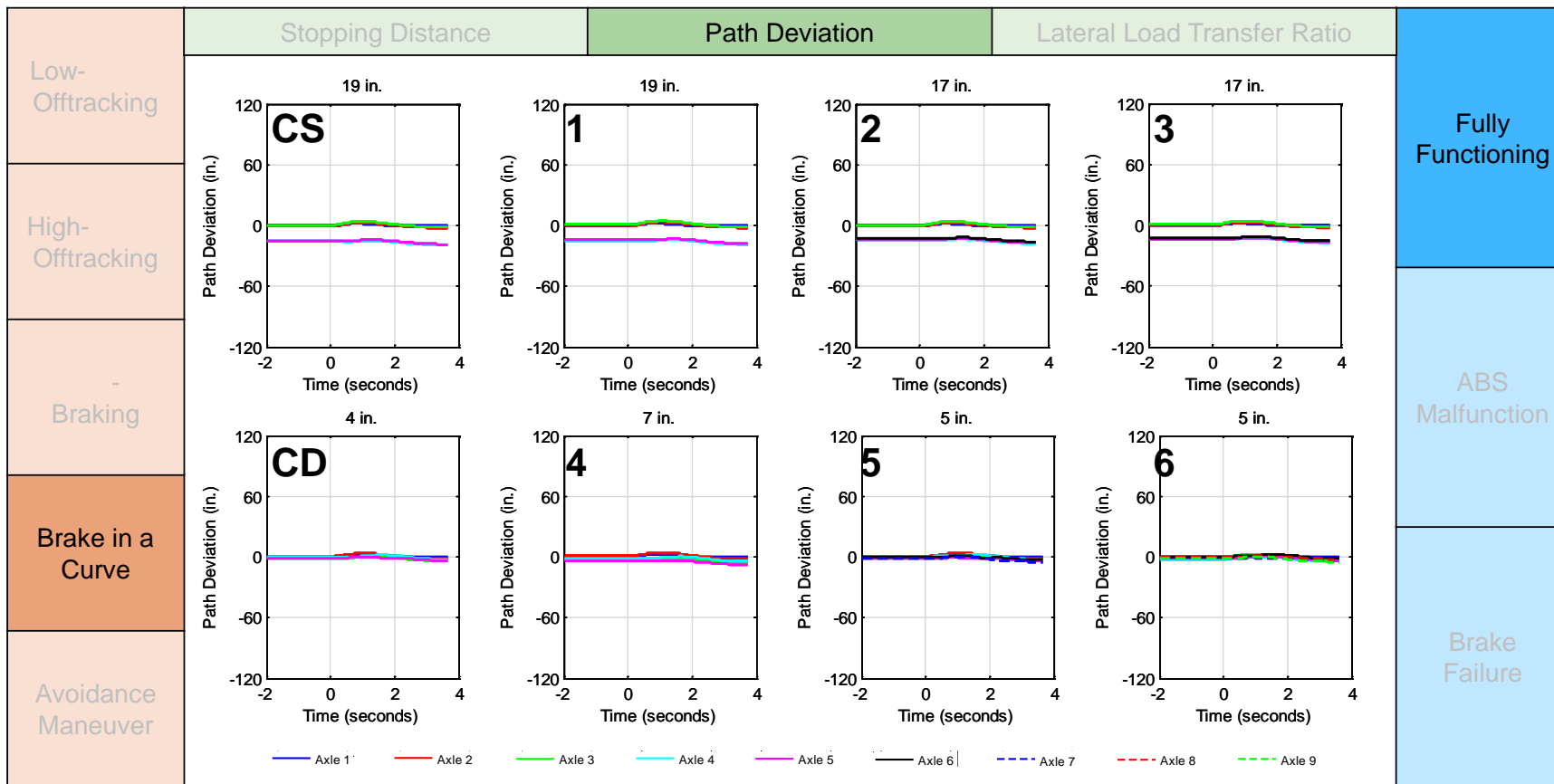


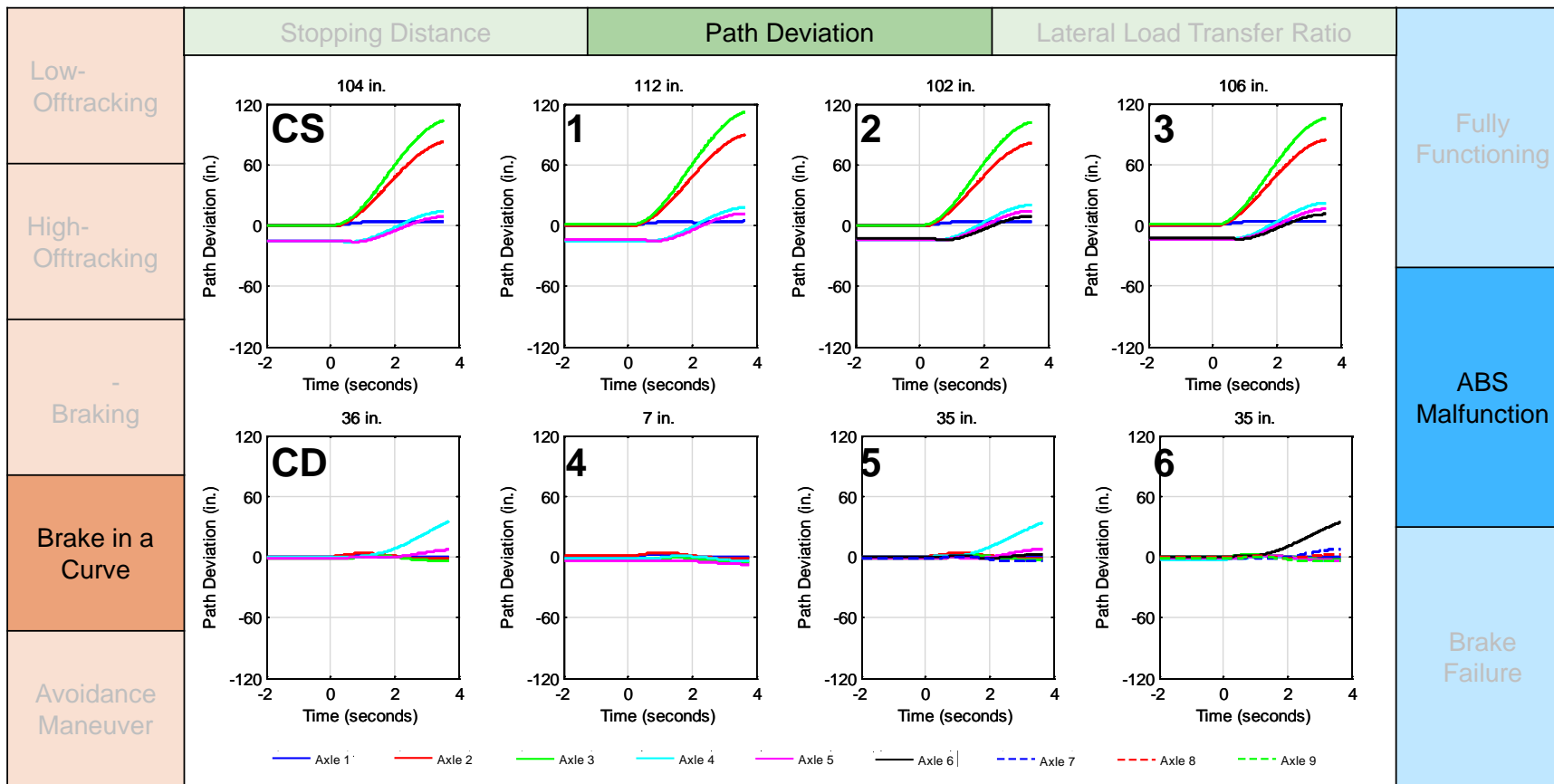


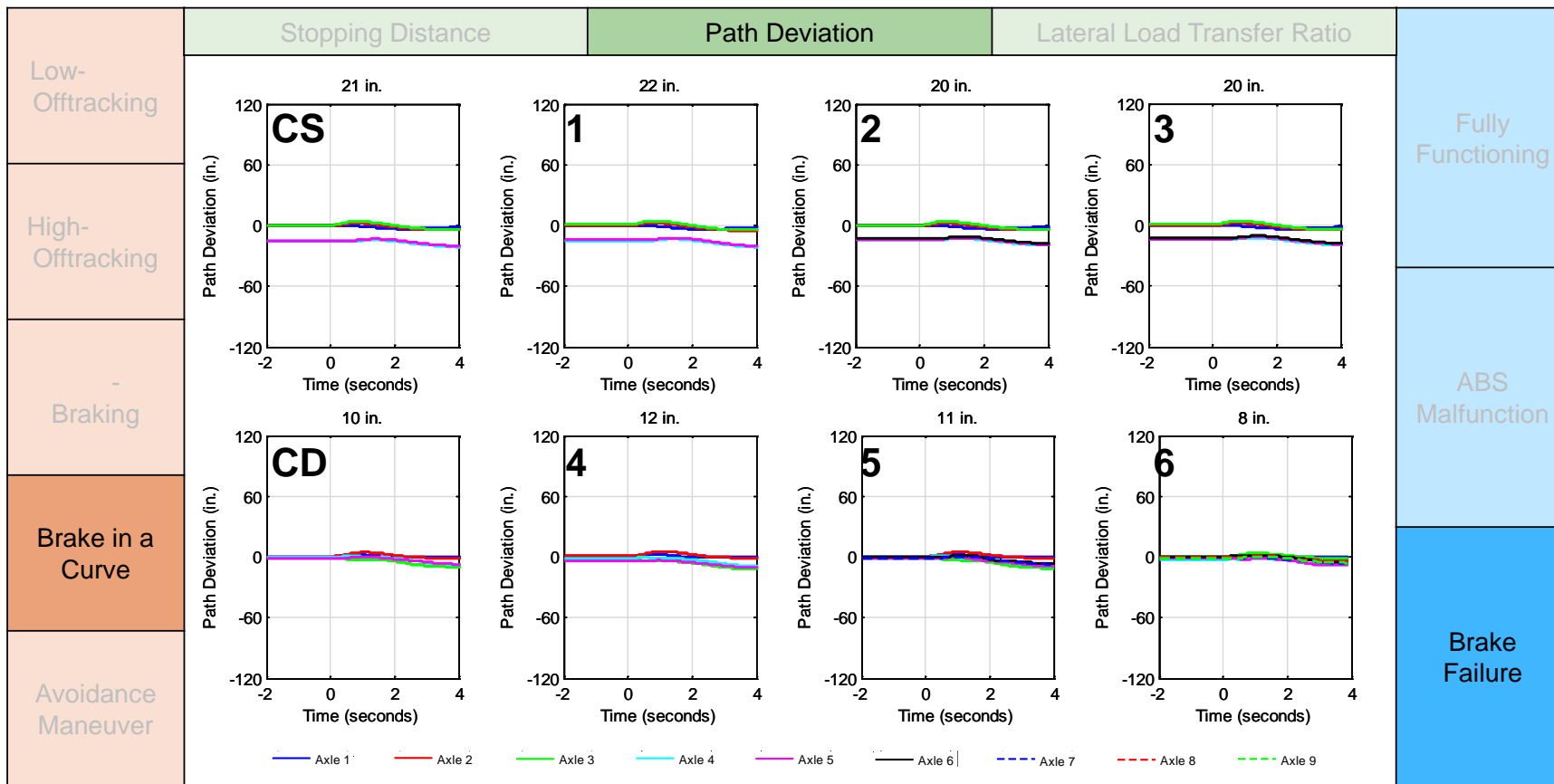




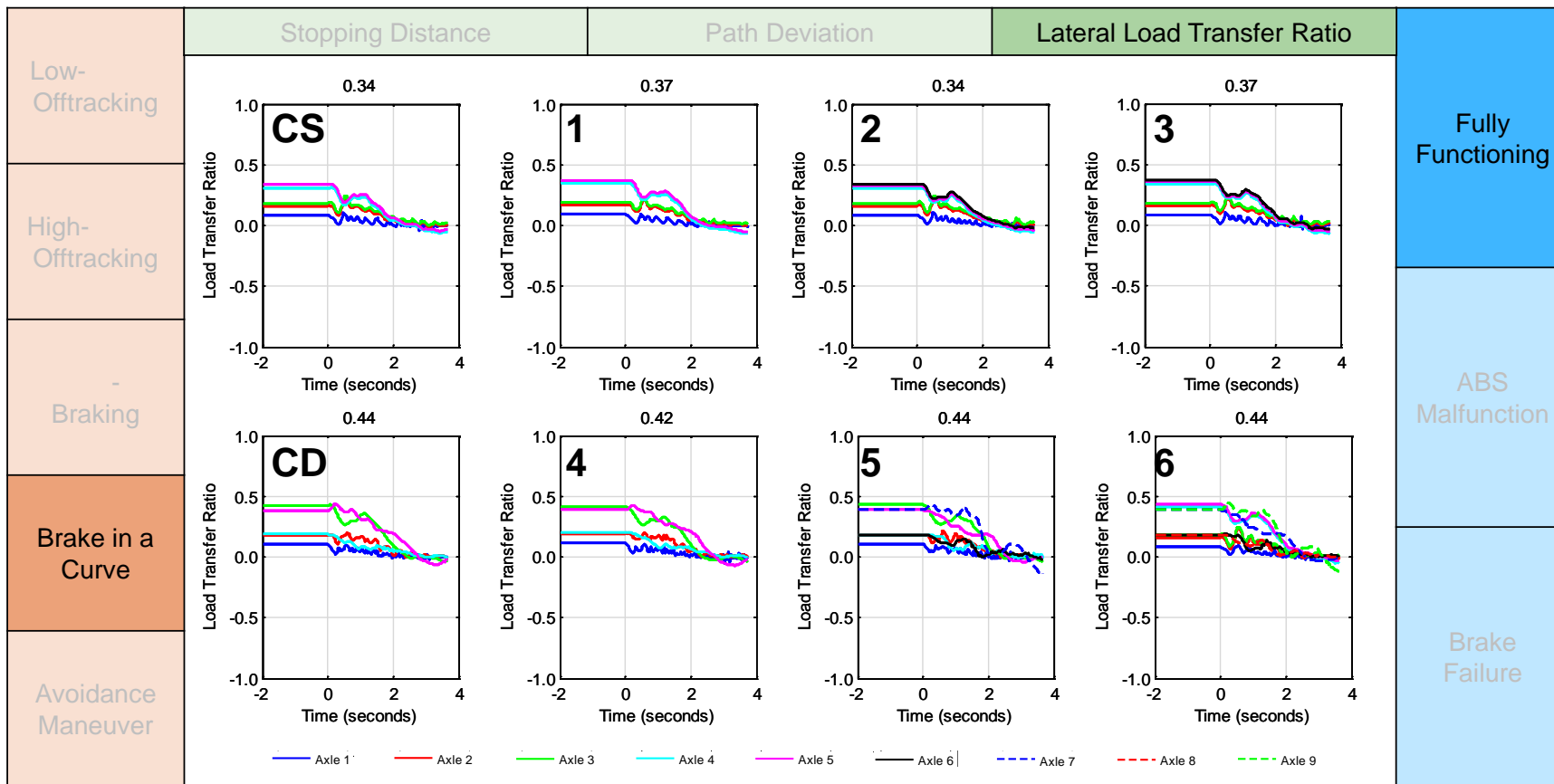


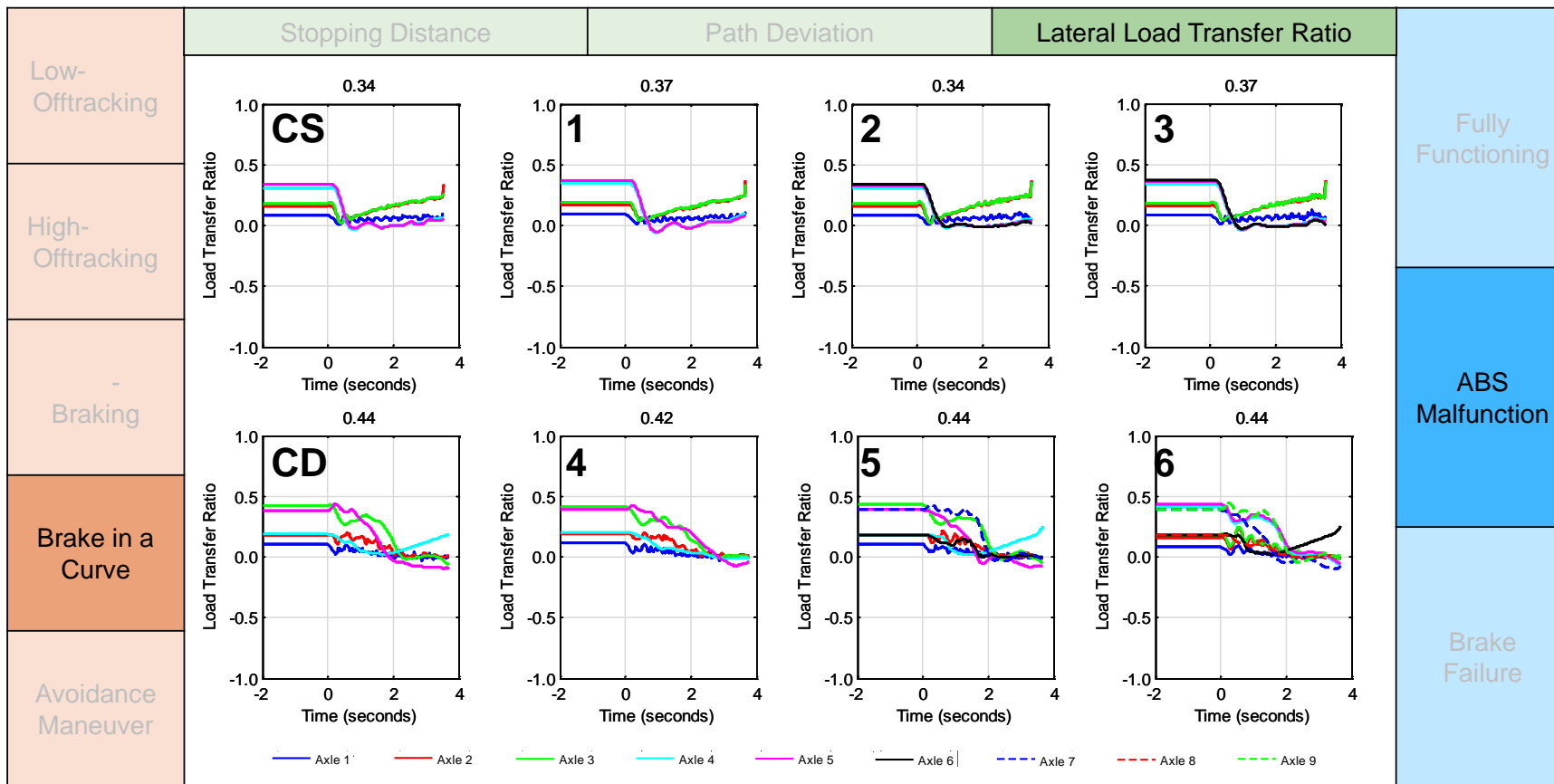


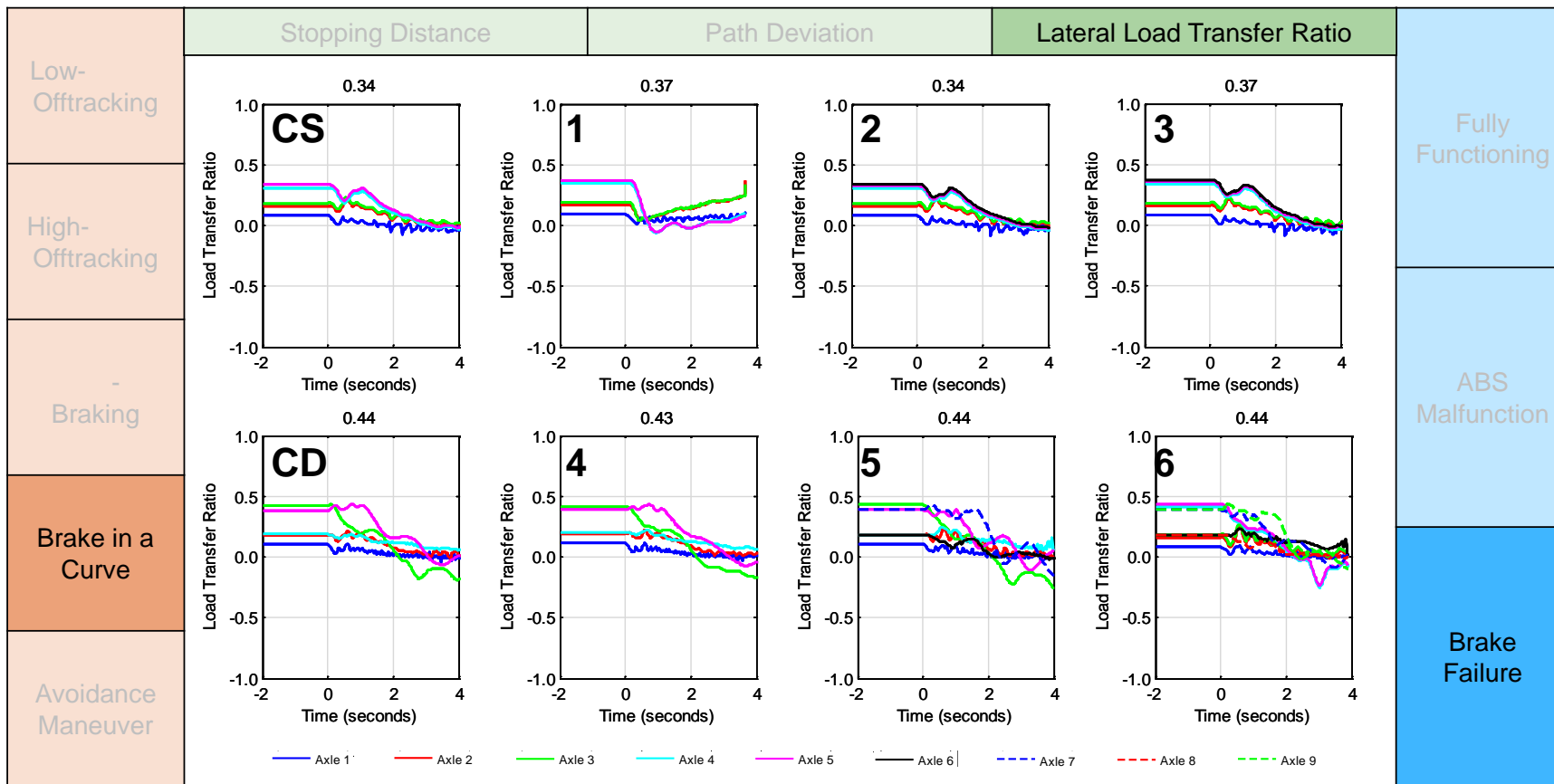


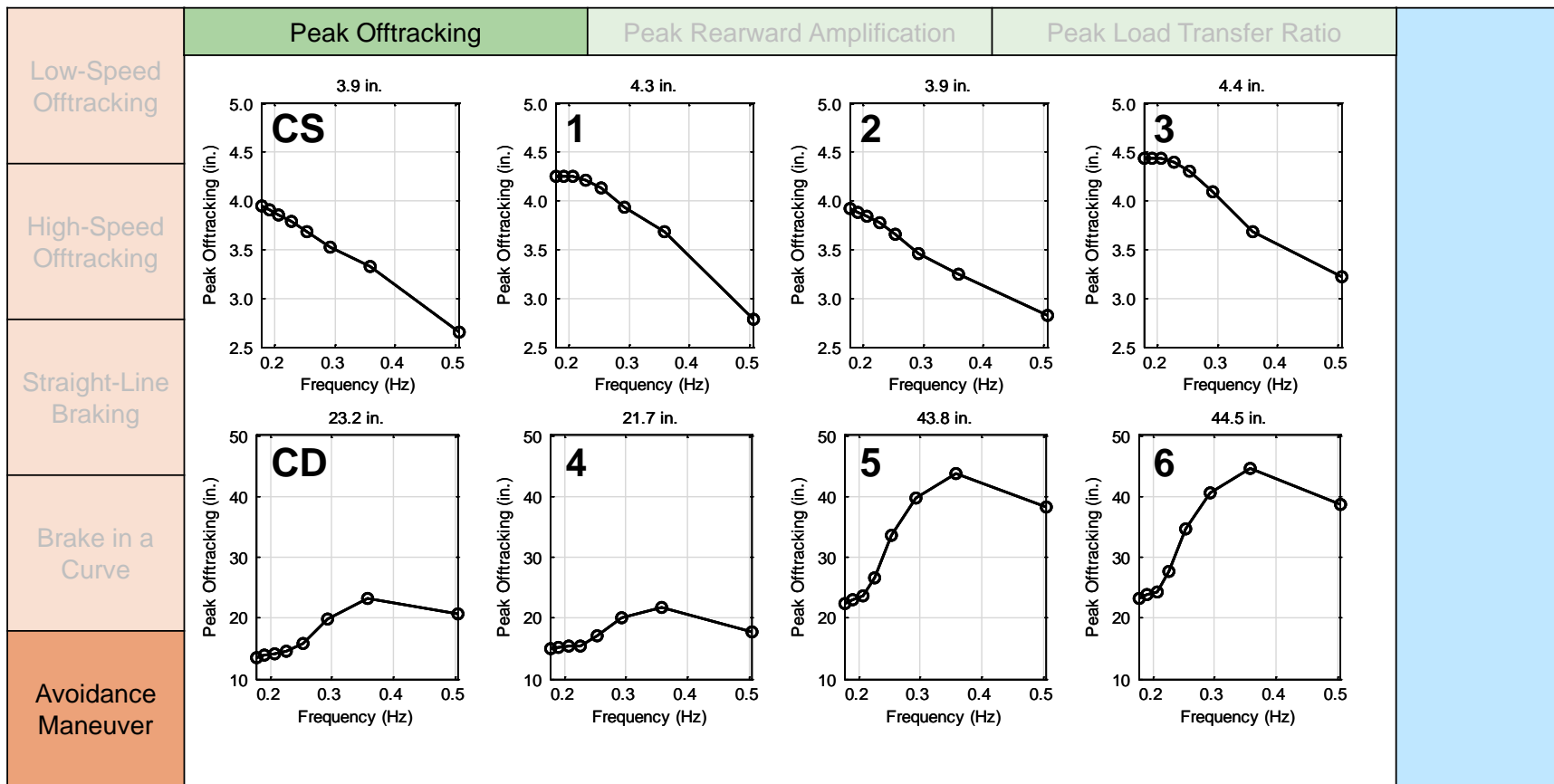


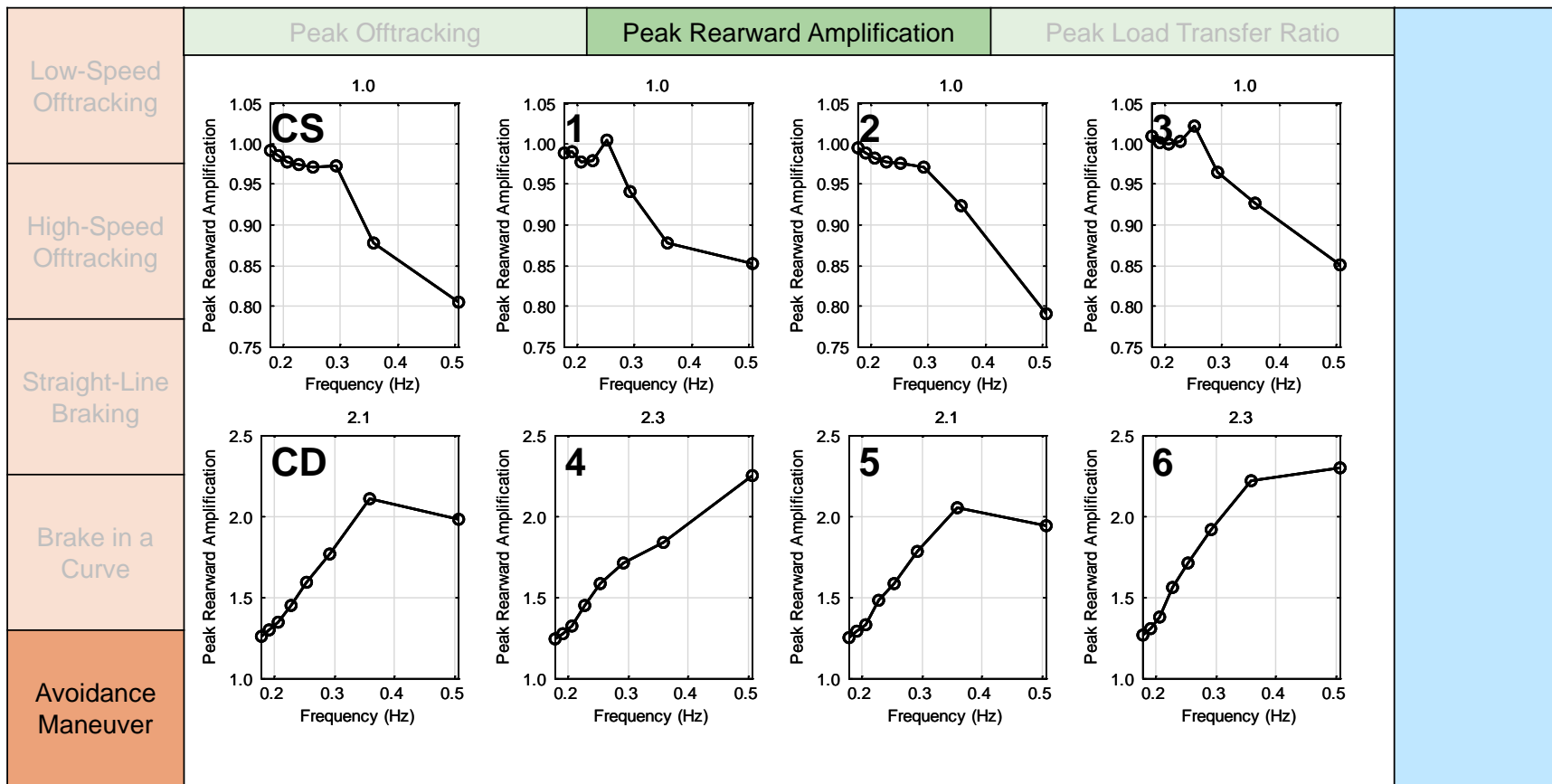


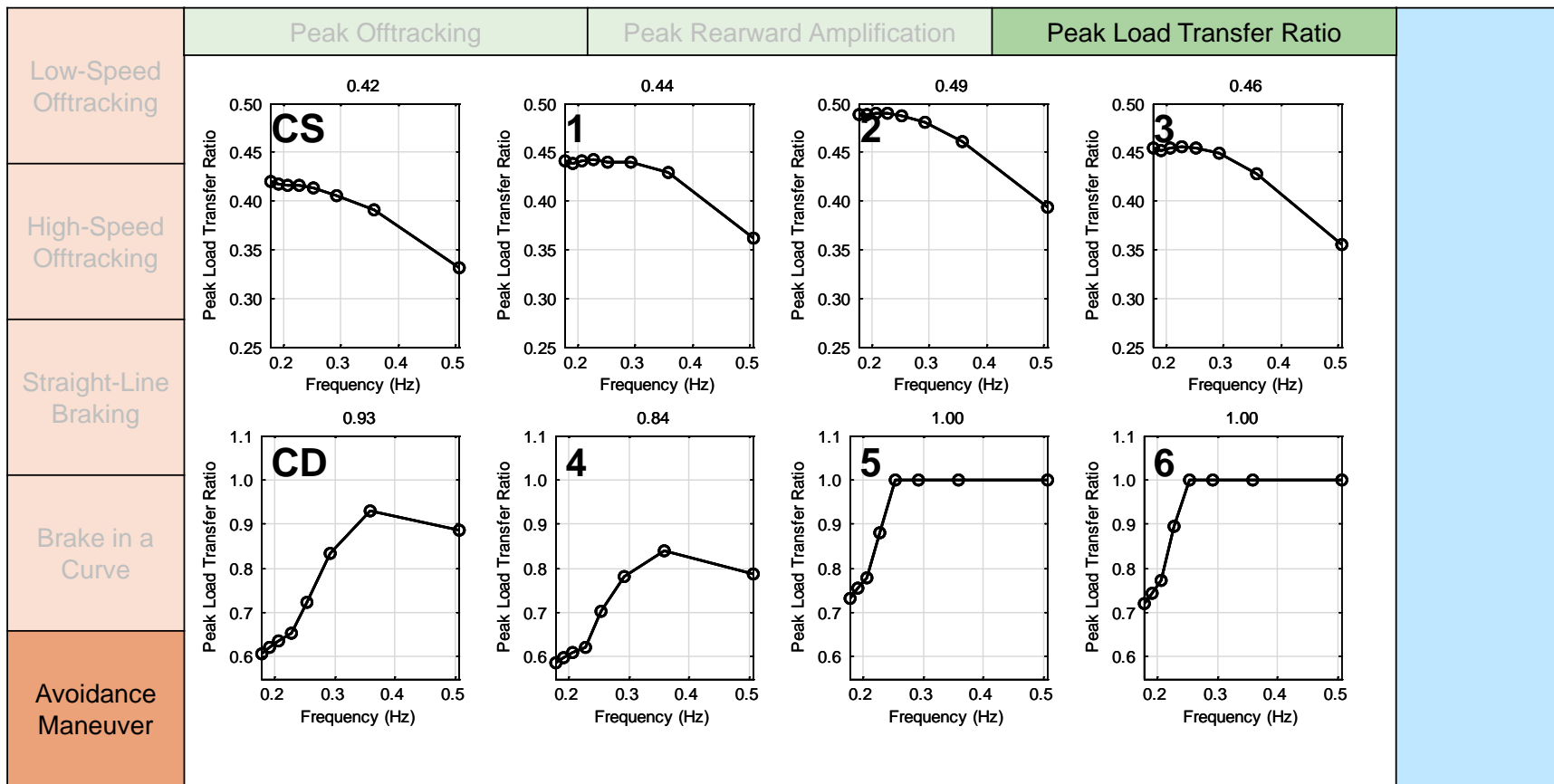












**APPENDIX F. INSPECTION AND VIOLATION RESULTS**

**Violation Categories**

The top 15 violation categories associated with safety inspections were tabulated for vehicles with weights at or below 80,000 lbs. GVW and with weights greater than 80,000 lbs. (**Table F1**). Similar tables were created for the different truck configurations of interest (**Tables F2 to F6**).

**Table F1. Top 15 Violation Categories by Weight Threshold**

| Operated at or Below 80,000 pounds                   |                       |          |                     | Operated Over 80,000 pounds  |                       |          |                     |
|--|-----------------------|----------|---------------------|------------------------------|-----------------------|----------|---------------------|
| Violation category                                   | Total # of violations | (%)      | Avg # of violations | Violation category           | Total # of violations | (%)      | Avg # of violations |
| Brakes, All Other Violations                         | 244984                | (21.60%) | 0.63                | Brakes, All Other Violations | 112865                | (36.80%) | 1.271               |
| Lighting   | 208368                | (18.40%) | 0.536               | Lighting                     | 42239                 | (13.80%) | 0.476               |
| All Other Vehicle Defects                            | 149617                | (13.20%) | 0.385               | All Other Vehicle Defects    | 33486                 | (10.90%) | 0.377               |
| Emergency Equipment                                  | 76194                 | (6.70%)  | 0.196               | Tires                        | 20202                 | (6.60%)  | 0.227               |
| All Other Driver Violations                          | 74239                 | (6.50%)  | 0.191               | Brakes, Out of Adjustment    | 17659                 | (5.80%)  | 0.199               |
| Tires  | 60595                 | (5.30%)  | 0.156               | All Other Driver Violations  | 8941                  | (2.90%)  | 0.101               |
| Periodic Inspection                                  | 42506                 | (3.70%)  | 0.109               | Suspension                   | 6947                  | (2.30%)  | 0.078               |
| Medical Certificate                                  | 36276                 | (3.20%)  | 0.093               | Load Securement              | 6061                  | (2.00%)  | 0.068               |
| Brakes, Out of Adjustment                            | 30607                 | (2.70%)  | 0.079               | Emergency Equipment          | 5988                  | (2.00%)  | 0.067               |
| Load Securement                                      | 30222                 | (2.70%)  | 0.078               | Periodic Inspection          | 5728                  | (1.90%)  | 0.064               |
| Windshield   | 25599                 | (2.3%)   | 0.066               | All Other Hours Of Service   | 5440                  | (1.80%)  | 0.061               |
| No Log Book, Log Not Current, General Log Violations | 19765                 | (1.70%)  | 0.051               | Windshield                   | 4715                  | (1.50%)  | 0.053               |
| Suspension   | 15517                 | (1.40%)  | 0.04                | Frames                       | 4523                  | (1.50%)  | 0.051               |
| All Other Hours Of Service                           | 13517                 | (1.20%)  | 0.035               | Size and Weight              | 4088                  | (1.30%)  | 0.046               |
| Steering Mechanism                                   | 12358                 | (1.10%)  | 0.032               | Steering Mechanism           | 4072                  | (1.30%)  | 0.046               |



**Table F2. Top 15 Violation Categories for 80,000 lb Tractor Semitrailer.**

| <b>Violation category</b>                            | <b>Total # of violations (%)</b> |         | <b>Avg # of violations</b> |
|--|----------------------------------|---------|----------------------------|
| Brakes, All Other Violations                         | 53101                            | (35.0%) | 1.154                      |
| Lighting   | 21678                            | (14.3%) | 0.471                      |
| All Other Vehicle Defects                            | 17365                            | (11.5%) | 0.377                      |
| Tires  | 11127                            | (7.3%)  | 0.242                      |
| Brakes, Out of Adjustment                            | 7376                             | (4.9%)  | 0.160                      |
| All Other Driver Violations                          | 5059                             | (3.3%)  | 0.110                      |
| Emergency Equipment                                  | 3589                             | (2.4%)  | 0.078                      |
| All Other Hours Of Service                           | 3566                             | (2.4%)  | 0.078                      |
| Windshield   | 2996                             | (2.0%)  | 0.065                      |
| Suspension   | 2925                             | (1.9%)  | 0.064                      |
| Steering Mechanism                                   | 2583                             | (1.7%)  | 0.056                      |
| Load Securement                                      | 2522                             | (1.7%)  | 0.055                      |
| No Log Book, Log Not Current, General Log Violations | 2327                             | (1.5%)  | 0.051                      |
| Periodic Inspection                                  | 2315                             | (1.5%)  | 0.050                      |
| 10/15 Hours  | 2263                             | (1.5%)  | 0.049                      |

**Table F3. Top 15 Violation Categories for 88,000 lb Tractor Semitrailer.**

| <b>Violation category</b>    | <b>Total # of violations (%)</b> |         | <b>Avg # of violations</b> |
|------------------------------|----------------------------------|---------|----------------------------|
| Brakes, All Other Violations | 950                              | (35.8%) | 1.221                      |
| Lighting                     | 359                              | (13.5%) | 0.461                      |
| All Other Vehicle Defects    | 309                              | (11.6%) | 0.397                      |
| Brakes, Out of Adjustment    | 177                              | (6.7%)  | 0.228                      |
| Tires                        | 161                              | (6.1%)  | 0.207                      |
| All Other Driver Violations  | 87                               | (3.3%)  | 0.112                      |
| Suspension                   | 79                               | (3.0%)  | 0.102                      |
| Emergency Equipment          | 70                               | (2.6%)  | 0.090                      |
| Steering Mechanism           | 58                               | (2.2%)  | 0.075                      |
| Exhaust Discharge            | 53                               | (2.0%)  | 0.068                      |
| Frames                       | 53                               | (2.0%)  | 0.068                      |
| Load Securement              | 51                               | (1.9%)  | 0.066                      |
| Size and Weight              | 43                               | (1.6%)  | 0.055                      |
| Windshield                   | 40                               | (1.5%)  | 0.051                      |
| All Other Hours Of Service   | 29                               | (1.1%)  | 0.037                      |

**Table F4. Top 15 Violation Categories for 91,000 lb Tractor Semitrailer.**

| <b>Violation category</b>                               | <b>Total # of violations (%)</b> |         | <b>Avg # of violations</b> |
|---|----------------------------------|---------|----------------------------|
| Brakes, All Other Violations                            | 1642                             | (35.7%) | 1.244                      |
| Lighting  | 662                              | (14.4%) | 0.502                      |
| All Other Vehicle Defects                               | 595                              | (12.9%) | 0.451                      |
| Tires   | 321                              | (7.0%)  | 0.243                      |
| Brakes, Out of Adjustment                               | 284                              | (6.2%)  | 0.215                      |
| All Other Driver Violations                             | 148                              | (3.2%)  | 0.112                      |
| Suspension  | 113                              | (2.5%)  | 0.086                      |
| Size and Weight   | 98                               | (2.1%)  | 0.074                      |
| Periodic Inspection                                     | 91                               | (2.0%)  | 0.069                      |
| Emergency Equipment                                     | 89                               | (1.9%)  | 0.067                      |
| Load Securement   | 84                               | (1.8%)  | 0.064                      |
| Frames  | 83                               | (1.8%)  | 0.063                      |
| Windshield  | 65                               | (1.4%)  | 0.049                      |
| Exhaust Discharge                                       | 53                               | (1.2%)  | 0.040                      |
| No Log Book, Log Not Current,<br>General Log Violations | 52                               | (1.1%)  | 0.039                      |

**Table F5. Top 15 Violation Categories for 97,000 lb Tractor Semitrailer.**

| <b>Violation category</b>    | <b>Total # of violations (%)</b> |         | <b>Avg # of violations</b> |
|------------------------------|----------------------------------|---------|----------------------------|
| Brakes, All Other Violations | 2109                             | (35.3%) | 1.326                      |
| Lighting                     | 796                              | (13.3%) | 0.501                      |
| All Other Vehicle Defects    | 735                              | (12.3%) | 0.462                      |
| Brakes, Out of Adjustment    | 414                              | (6.9%)  | 0.260                      |
| Tires                        | 374                              | (6.3%)  | 0.235                      |
| All Other Driver Violations  | 226                              | (3.8%)  | 0.142                      |
| Suspension                   | 160                              | (2.7%)  | 0.101                      |
| Frames                       | 151                              | (2.5%)  | 0.095                      |
| Emergency Equipment          | 137                              | (2.3%)  | 0.086                      |
| Size and Weight              | 113                              | (1.9%)  | 0.071                      |
| Windshield                   | 106                              | (1.8%)  | 0.067                      |
| Load Securement              | 102                              | (1.7%)  | 0.064                      |
| Steering Mechanism           | 92                               | (1.5%)  | 0.058                      |
| Periodic Inspection          | 74                               | (1.2%)  | 0.047                      |
| Wheels, Studs, Clamps, Etc.  | 74                               | (1.2%)  | 0.047                      |

**Table F6. Top 15 Violation Categories for Twin and Triple Trailers.**

| Top Violations | Category                     | Tractor Twin-trailer (80K) Total (and Percent) |          | Mean  | Category   | Tractor Triple-trailer Total # (and Percent) |          | Mean  |
|----------------|------------------------------|--|----------|-------|--|--|----------|-------|
| 1              | Brakes, All Other Violations | 1835   | (34.00%) | 1.831 | Brakes, All Other Violations                         | 67   | (40.60%) | 0.931 |
| 2              | Lighting                     | 770  | (14.30%) | 0.768 | All Other Vehicle Defects                            | 38   | (23.00%) | 0.528 |
| 3              | All Other Vehicle Defects    | 645  | (11.90%) | 0.644 | Lighting   | 16   | (9.70%)  | 0.222 |
| 4              | Tires                        | 369  | (6.80%)  | 0.368 | Tires  | 7  | (4.20%)  | 0.097 |
| 5              | Brakes, Out of Adjustment    | 294  | (5.40%)  | 0.293 | Brakes, Our of Adjustment                            | 5  | (3.00%)  | 0.069 |
| 6              | Suspension                   | 205  | (3.80%)  | 0.205 | All Other Driver Violations                          | 4  | (2.40%)  | 0.056 |
| 7              | All Other Driver Violations  | 180  | (3.30%)  | 0.18  | Emergency Equipment                                  | 4  | (2.40%)  | 0.056 |
| 8              | Periodic Inspection          | 132  | (2.40%)  | 0.132 | Frames   | 4  | (2.40%)  | 0.056 |
| 9              | Windshield                   | 118  | (2.20%)  | 0.118 | Wheels, Studs, Clamps, Etc.                          | 4  | (2.40%)  | 0.056 |
| 10             | Emergency Equipment          | 89   | (1.60%)  | 0.089 | All Other Hours Of Service                           | 3  | (1.80%)  | 0.042 |
| 11             | Coupling Devices             | 80   | (1.50%)  | 0.08  | No Log Book, Log Not Current, General Log Violations | 3  | (1.80%)  | 0.042 |
| 12             | Load Securement              | 77   | (1.40%)  | 0.077 | Shipping Papers                                      | 3  | (1.80%)  | 0.042 |
| 13             | Wheels, Studs, Clamps, Etc.  | 77   | (1.40%)  | 0.077 | Steering Mechanism                                   | 3  | (1.80%)  | 0.042 |
| 14             | Frames                       | 68   | (1.30%)  | 0.068 | Windshield   | 3  | (1.80%)  | 0.042 |
| 15             | Steering Mechanism           | 66   | (1.20%)  | 0.066 | Improper Placarding                                  | 2  | (1.20%)  | 0.028 |

**APPENDIX G. INSPECTION LEVEL DESCRIPTIONS  
(FMCSA MOTOR CARRIER MANAGEMENT INFORMATION SYSTEM)**

***LEVEL I***

North American Standard Inspection – An inspection that includes examination of driver’s license; medical examiner’s certificate and Skill Performance Evaluation (SPE) Certificate (if applicable); alcohol and drugs; driver’s record of duty status as required; hours of service; seat belt; vehicle inspection report(s) (if applicable); brake systems; coupling devices; exhaust systems; frames; fuel systems; lighting devices (headlamps, tail lamps, stop lamps, turn signals and lamps/flags on projecting loads); securement of cargo; steering mechanisms; suspensions; tires; van and open-top trailer bodies; wheels, rims and hubs; windshield wipers; emergency exits and/or electrical cables and systems in engine and battery compartments (buses), and HM/DG requirements as applicable. HM/DG required inspection items will be inspected by certified HM/DG inspectors.

***LEVEL II***

Walk-Around Driver/Vehicle Inspection – An examination that includes each of the items specified under the North American Standard Level II Walk-Around Driver/Vehicle Inspection Procedure. As a minimum, Level II inspections must include examination of: driver’s license; medical examiner’s certificate and Skill Performance Evaluation (SPE) Certificate (if applicable); alcohol and drugs; driver’s record of duty status as required; hours of service; seat belt; vehicle inspection report(s) (if applicable); brake systems; coupling devices; exhaust systems; frames; fuel systems; lighting devices (headlamps, tail lamps, stop lamps, turn signals and lamps/flags on projecting loads); securement of cargo; steering mechanisms; suspensions; tires; van and open-top trailer bodies; wheels, rims and hubs; windshield wipers; emergency exits and/or electrical cables and systems in engine and battery compartments (buses), and HM/DG requirements as applicable. HM/DG required inspection items will be inspected by certified HM/DG inspectors. It is contemplated that the walk-around driver/vehicle inspection will include only those items, which can be inspected without physically getting under the vehicle.

***LEVEL III***

Driver/Credential Inspection – An examination that includes those items specified under the North American Standard Level III Driver/Credential Inspection Procedure. As a minimum, Level III inspections must include, where required and/or applicable, examination of the driver’s license; medical examiner’s certificate and Skill Performance Evaluation (SPE) Certificate; driver’s record of duty status; hours of service; seat belt; vehicle inspection report(s); and HM/DG requirements. Those items not indicated in the North American Standard Level III Driver/Credential Inspection Procedure shall not be included on a Level III inspection.